

---

# Antenna Modeling for Radio Amateurs Revised and Expanded

**Steve Stearns, K6OIK**

**Consulting Engineer  
Electromagnetic Systems  
Antennas and RF Design**

**Technical Fellow, ret.  
Northrop Grumman Corp.**

**[stearns@ieee.org](mailto:stearns@ieee.org)**

**[k6oik@arrl.net](mailto:k6oik@arrl.net)**

# Abstract

---

Where do antenna modeling programs come from, how do they work, what are their limitations, what is the state of the art? These questions and others will be answered by Steve Stearns, K6OIK, in this tutorial introduction to antenna modeling. Steve will review the historical timeline of events that led to modern computational electromagnetics.

Steve will tell which antenna modeling programs are free or inexpensive, the capabilities of different software to handle various shapes and materials, and which show results as graphs, 3D depictions, or movies of full-wave simulations. Also covered is meshing by 1D segments, 2D surface patches, and 3D voxels needed to compute fields inside inhomogeneous dielectric objects such as people.

This presentation will show the power of modern computational electromagnetics to solve practical problems in antenna engineering and Amateur Radio.

# Speaker's Biography



- **Stephen D. Stearns**
- **Technical Fellow, ret., Northrop Grumman Corp.**
- **40 years experience in electronic systems**
  - Northrop Grumman, TRW, GTE Sylvania, Hughes Aircraft
  - Electromagnetic and signal processing systems for communications and radar surveillance, cochannel signal separation, measurement, identification, characterization, polarimetric array signal processing of ionospheric skywave signals for precision geolocating HF emitters, sensor fusion
  - Recent work: Antenna and scattering theory; Non-Foster circuits for antennas and metamaterials; antennas to radiate OAM Bessel-Vortex beams; double-reflectionless harmonic reject filters
- **FCC licenses**
  - Amateur Radio Extra Class
  - 1<sup>st</sup>-Class Radiotelephone
  - General Radio Operator License (GROL)
  - Ship Radar Endorsement
- **Education**
  - Stanford – under Prof. T.M. Cover
  - USC – under Profs. H.H. Kuehl and C.L. Weber
  - CSUF – under Profs. J.E. Kemmerly and G.I. Cohn
- **More than 100 publications and presentations, both professional (IEEE) and hobbyist (Amateur Radio)**

# ARRL Pacificon Presentations by K6OIK

Archived at

<http://www.fars.k6ya.org>

1999	Mysteries of the Smith Chart	
2000	Jam-Resistant Repeater Technology	
2001	Mysteries of the Smith Chart	✓
2002	How-to-Make Better RFI Filters Using Stubs	
2003	Twin-Lead J-Pole Design	
2004	Antenna Impedance Models – Old and New	✓
2005	Novel and Strange Ideas in Antennas and Impedance Matching	
2006	Novel and Strange Ideas in Antennas and Impedance Matching II	✓
2007	New Results on Antenna Impedance Models and Matching	✓
2008	Antenna Modeling for Radio Amateurs	
2010	Facts About SWR, Reflected Power, and Power Transfer on Real Transmission Lines with Loss	✓
2011	Conjugate Match Myths	✓
2012	Transmission Line Filters Beyond Stubs and Traps	✓
2013	Bode, Chu, Fano, Wheeler – Antenna Q and Match Bandwidth	✓
2014	A Transmission Line Power Paradox and Its Resolution	✓
2015	Weird Waves: Exotic Electromagnetic Phenomena	✓
2015	The Joy of Matching: How to Design Multi-Band Match Networks	✓
2016	The Joy of Matching 2: Multi-Band and Reflectionless Match Networks	
2016-7	Antenna Modeling for Radio Amateurs – Revised and Expanded	✓
2017	VHF-UHF Propagation Planning for Amateur Radio Repeaters	

# ARRL Antenna Book, 23e, Chapter 8



My contribution

## Chapter 8

# Antenna Modeling

### 8.1 OVERVIEW: ANTENNA ANALYSIS BY COMP

As pointed out in The Effects of Ground chapter, irregular local terrain can have a profound effect on HF signals into the ionosphere. A system approach as described in the HF Antenna System Design chapter is needed to create a scientifically planned station. Antenna modeling programs do not generally take into account the effects of irregular terrain and by "irregular" we mean any sort of ground that is not flat. Most modeling programs based on NEC-2 or MININEC do model reflections, but they do not model diffractions.

On the other hand, while a ray-tracing program like HFTA (HF Terrain Assessment by Dean Straw, NGBV — described in the HF Antenna System Design chapter) does take into account diffraction, it doesn't explicitly factor in the mutual impedance between an antenna and the ground. Instead, HFTA makes the basic assumption that the antenna is mounted sufficiently high above ground so that the mutual impedance between an antenna and the ground is minimal.

In this chapter we'll look at modeling the antennas themselves on the PC. We'll evaluate some typical antennas over flat ground and also in free space. Once characterized — or even optimized for certain characteristics — these antennas can then be analyzed over real terrain using HFTA and the other tools discussed in the HF Antenna System Design chapter. Previous editions of this book have included EZNEC-ARRL, a version of EZNEC antenna modeling software that worked with a special set of model files. Effective with this edition, the demo version of EZNEC 6.0 will run all EZNEC-ARRL models, subject to the limitations spelled out in the demo version documentation. The demo version of EZNEC 6.0 is free and can be downloaded from [www.eznect.com](http://www.eznect.com). Previous versions of EZNEC-ARRL will continue to operate properly with EZNEC-ARRL files as before. Model files including those referenced in this chapter are provided as supplementary content on the CD-ROM that comes with the ARRL Antenna Book.

#### 8.1.1 A SHORT HISTORY OF ANTENNA MODELING

With the proliferation of personal computers since the early 1980s, amateurs and professionals alike have made

significant strides in computerizing antenna modeling. It is now possible for the amateur using a personal computer to evaluate even complex antenna systems — a subject that many in the past. We might add that allow means to debunk overblown antennas.

The most commonly encountered analysis are those derived from government laboratories called "Electromagnetics Code." NEC (Numerical Electromagnetics Code) is the most commonly encountered. It is a numerical method of dealing with antennas. The most commonly encountered analysis are those derived from government laboratories called "Electromagnetics Code." NEC (Numerical Electromagnetics Code) is the most commonly encountered. It is a numerical method of dealing with antennas.

The mathematics behind the formidable, but the basic principle broken down into a number of smaller pieces. The field resulting from the antenna is evaluated by itself and also coupled segments. Finally, the field is segmented is vector-summed to yield the total field. This is done by computing for any elevation or effects of flat-earth ground reflect ground conductivity and dielectric constant.

In the early 1980s, MININEC was used on personal computers. Because of the speed and accuracy of personal computers, it was that perfect ground was assumed, even though the radiating antenna take into account real ground. Antennas modeled closer to ground

### 8.3 REFERENCES AND BIBLIOGRAPHY

Steve Stearns, K6OIK, contributed this set of references for the 23rd edition of the Antenna Book.

#### Amateur Radio Literature

- 1) J.L. Lawson, W2PV, "Yagi Antenna Design Experiments Confirm Computer Analysis," *Ham Radio*, Feb 1980, pp 19-27.
- 2) R. Lewallen, W7EL, "MININEC: The Other Side of the Sword," *QST*, Feb 1991, p 18-22.
- 3) L.B. Cebik, W4RNL, "A Beginner's Guide to Using Computer Antenna Modeling Programs," *ARRL Antenna Compendium*, Vol 3, ARRL, 1992, pp 148-155.
- 4) J.S. Belrose, VE2CV, "Modeling HF Antennas with MININEC: Guidelines and Tips from a Code-Users Notebook," *ARRL Antenna Compendium*, Vol 3, ARRL, 1992, pp 156-164.
- 5) R.P. Haviland, W4MB, "Programs for Antenna Analysis by the Method of Moments," *ARRL Antenna Compendium*, Vol 4, ARRL, 1995, pp 69-73.
- 6) R.P. Haviland, W4MB, "Ground parameters for Antenna Analysis," *ARRL Antenna Compendium*, Vol 5, ARRL, 1996, pp 96-100.
- 7) L.B. Cebik, W4RNL, "NEC and MININEC Antenna Modeling Programs: A Guide to Further Information," *QEX*, Mar/Apr 1998, pp 47-49.
- 8) J. Rockway and J. Logan, N6BRR, "Wire Modeling Limitations of NEC and MININEC for Windows," *QEX*, May/June 1998, pp 17-21.
- 9) M. Tracy, KC1SX, "EZNEC 3.0 for Windows," *Short Takes*, *QST*, Sep 2000, p 66.
- 10) L.B. Cebik, W4RNL, "A Beginner's Guide to Modeling with NEC," a four part series in *QST*, Part 1, Nov 2000, pp 34-38; Part 2, Dec 2000, pp 40-44; Part 3, Jan 2001, pp 44-48; Part 4, Feb 2001, pp 31-35.
- 11) L.B. Cebik, W4RNL, *ARRL Antenna Modeling Course*, ARRL, 2003.
- 12) L.B. Cebik, W4RNL, "Notes on Modeling LPDAs in MININEC," *QST*, Jan 2004, pp 72-73.
- 13) L.B. Cebik, W4RNL, "Antenna Options: A Yagi Case Study Part 1 — Design Options," first of a three part article in *QEX*, Jul/Aug. 2004, pp 55-59.
- 14) L.B. Cebik, W4RNL, "Antenna Options: Modeling Software," a two-part series in *QEX*; Part 1, Sep/Oct 2005, pp 54-59; Part 2, Nov/Dec 2005, pp 50-56.
- 15) S. Stearns, K6OIK, "Antenna Modeling for Radio Amateurs," *ARRL Pacific Northwest Antenna Seminar*, San Ramon, CA, A. 17, 2008. Download from [www.fars.k6ya.org/docs/ks6oik](http://www.fars.k6ya.org/docs/ks6oik)
- 16) W. Silver, N0AX, *Antenna Modeling for Beginners: An Introductory Guide to Using Antenna Modeling Software*, ARRL, 2012.
- 17) S. Nichols, G0KYA, *An Introduction to Antenna Modeling*, RSGB, 2014.

- 30) U. Jakobus, DG6SHF, "Numerical Computation of the Near-Field of Typical Amateur Radio Antennas and Comparison with Approximate Results of Far-Field Region," 2000. Online. Comparison of Results of Near-Field Modeling of Progress in Applied Electromagnetics, Monterey, CA, Mar 2001.

#### Professional Literature

- 18) J.H. Richmond, "A Wire-Grid Model for Scattering by Conducting Bodies," *IEEE Transactions on Antennas and Propagation*, Vol 14, No 6, Nov 1966, pp 782-786.
- 19) R.F. Harrington, "Matrix Methods for Field Problems," *Proc. IEEE*, Vol 55, No 2, Feb 1967, pp 136-149.
- 20) R.F. Harrington, *Field Computation by Moment Methods*, Macmillan, 1968. Republished by Krieger, 1981, and IEEE-Wiley, 1993.
- 21) J.P.Y. Lee and K.G. Balmain, "Wire Antennas Coated with Magnetically and Electrically Lossy Material," *Radiation Science*, Vol 14, No 3, May-June 1979, pp 437-445. Download from [onlinelibrary.wiley.com/doi/10.1002/ISSN1944-799X/issues](http://onlinelibrary.wiley.com/doi/10.1002/ISSN1944-799X/issues)
- 22) G.J. Burke and A.J. Poggio, *Numerical Electromagnetics Code (NEC)-Method of Moments*, Part I: Program Description-Theory; Part II: Program Description-Code; Part III: Users Guide, Tech. Rep. UCID-18834, Lawrence Livermore Laboratory, Jan 1981. Download all parts as DTIC document ADA956129 from [www.dtic.mil/dtic/tr/fulltext/u2/a956129.pdf](http://www.dtic.mil/dtic/tr/fulltext/u2/a956129.pdf)
- 23) S.M. Rao, D.R. Wilton, and A.W. Glisson, "Electromagnetic Scattering by Surfaces of Arbitrary Shape," *IEEE Transactions on Antennas and Propagation*, Vol 30, No 3, May 1982, pp 409-418.
- 24) A.J. Julian, J.C. Logan, and J.W. Rockway, *MININEC: A Mini-Numerical Electromagnetics Code*, Tech Doc. 516, DTIC ADA121535, Naval Ocean Systems Center, Sep 6, 1982. Download from [www.dtic.mil/dtic/tr/fulltext/u2/a121535.pdf](http://www.dtic.mil/dtic/tr/fulltext/u2/a121535.pdf)
- 25) B.D. Popovic and A. Nesic, "Generalisation of the Concept of Equivalent Radius of Thin Cylindrical Antennas," *IEEE Proc.*, Part H, Vol 131, No 3, Jun 1984, pp 153-158.
- 26) J.C. Logan and J.W. Rockway, *The New MININEC (Version 3): A Mini-Numerical Electromagnetics Code*, Tech. Doc. 938, DTIC ADA181682, Naval Ocean Systems Center, Sep 1986. Download from [www.dtic.mil/dtic/tr/fulltext/u2/a181682.pdf](http://www.dtic.mil/dtic/tr/fulltext/u2/a181682.pdf)
- 27) A.C. Ludwig, "Wire Grid Modeling of Surfaces," *IEEE Transactions on Antennas and Propagation*, Vol 35, No 9, Sep 1987, pp 1045-1048.
- 28) J.W. Rockway, J.C. Logan, S.T. Li, and D.W.S. Tam, *The MININEC System: Microcomputer Analysis of Wire Antennas*, Artech House, 1988.
- 29) G.J. Burke, *Numerical Electromagnetics Code - NEC-4, Method of Moments*, Part I: User's Manual (NEC-4.1); Part II: Program Description-Theory, Tech. Report UCRL-MA-109338, Jan 1992. Download both parts from [pubhpl.princeton.edu/~mcdonald/examples/NEC\\_Manuals](http://pubhpl.princeton.edu/~mcdonald/examples/NEC_Manuals)

- 31) U. Jakobus, DG6SHF, "Numerical Computation of the Near-Field of Typical Amateur Radio Antennas and Comparison with Approximate Results of Far-Field Region," 2000. Online. Comparison of Results of Near-Field Modeling of Progress in Applied Electromagnetics, Monterey, CA, Mar 2001.
- 32) Poggio, "The Numerical Method of Moments in Antennas and Propagation," 2004, pp 2871-2874. Download from [www.dtic.mil/dtic/tr/fulltext/u2/a304278.pdf](http://www.dtic.mil/dtic/tr/fulltext/u2/a304278.pdf)
- 33) R. Lewallen, W7EL, "MININEC: The Other Side of the Sword," *QST*, Feb 1991, p 18-22.
- 34) T.K. Sarkar, W.M. Dyab, M.N. Abdallah, M. Salazar-Palma, M.V.S.N. Prasad, and S.-W. Ting, "Application of the Schelknotoff Formulation to the Sommerfeld Problem of a Vertical Electric Dipole Radiating Over an Imperfect Ground," *IEEE Transactions on Antennas and Propagation*, Vol 62, No 8, Aug 2014, pp 4162-4170.

#### Software Websites

- 4nec2: [www.qsl.net/4nec2](http://www.qsl.net/4nec2)
- AUTOEZ: [www.ac6a.com/autoez.html](http://www.ac6a.com/autoez.html)
- COCONEC: [www.w7ay.com/site/Applications/coconec](http://www.w7ay.com/site/Applications/coconec)
- EZNEC: [www.eznect.com](http://www.eznect.com)
- Feko: [www.feko.info](http://www.feko.info)
- Feko Lite Free Demo: [www.feko.info/download/feko-lite](http://www.feko.info/download/feko-lite)
- HOBBIES: [www.em-hobbies.com](http://www.em-hobbies.com)
- MANANA-GAL: [hamssoft.ca/pages/manana-gal.php](http://hamssoft.ca/pages/manana-gal.php)
- NEC 4.2 (Lawrence Livermore National Lab): [ipol.nsl.gov/technologies/nec](http://ipol.nsl.gov/technologies/nec)
- WIPL-D: [www.wipl-d.com/products](http://www.wipl-d.com/products)
- WIPL-D Free Demo: [www.wipl-d.com/products.php?content=free-demo](http://www.wipl-d.com/products.php?content=free-demo)

Unofficial NEC archives of Ray Anderson WB6TUP: [ftp://nic.funet.fi/pub/hams/antenna/NEC/swindex.html](http://ftp://nic.funet.fi/pub/hams/antenna/NEC/swindex.html) or [nec-archives.psk3j.com](http://nec-archives.psk3j.com)

# Outline

---

- **History of electromagnetics**
- **History of computational electromagnetics (CEM)**
  - Method of Moments (MoM)
- **Antenna modeling programs for Radio Amateurs**
  - EZNEC
  - 4nec2
  - MININEC
  - MMANA-GAL Basic
  - FEKO
  - WIPL-D
  - HOBBIES
  - openEMS
- **Advanced applications**
  - Terrain Modeling as Alternative to HFTA
  - Monopole on Planet Cubo
  - Field Strength Inside Car for 2-meter Mobileers
  - Baking a Potato
  - And more...
- **References and resources**
  - Software for antenna modeling
  - Antenna books

# Question

- Is the current the same everywhere along a wire?



$$I_{in} \stackrel{?}{=} I_{out}$$

# Answer: It Depends

- “Yes” for steady-state *d-c* current
- “Almost yes” for low-frequency *a-c* current or short wires
- But “no” for high-frequency *a-c* current because electrons can bunch up
- James Clerk Maxwell found a way to turn “no” into “yes”

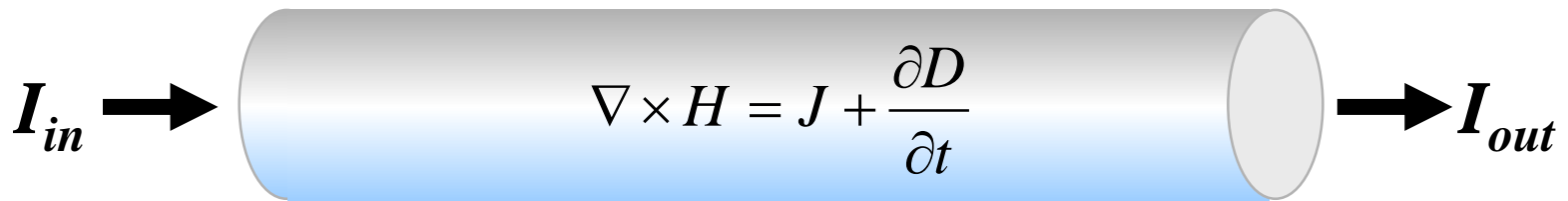
$$\nabla \times H = J + \frac{\partial D}{\partial t}$$
$$0 = \oiint_S \left( J + \frac{\partial D}{\partial t} \right) \cdot dS$$
$$I_{in} = I_{out} + \frac{\partial}{\partial t} \oiint_S D_n dS$$

Total current, conduction plus displacement current, entering is the same as that leaving every part of a wire !



---

# History

# Who Does Not Belong in this Picture?

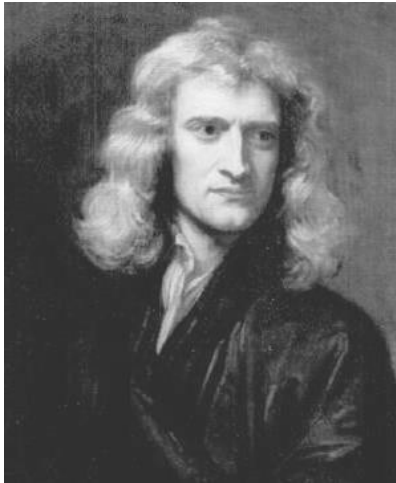
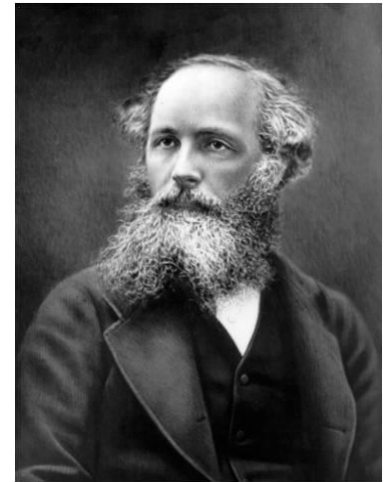

# Answer: Leonardo Da Vinci and Isaac Newton



**Leonardo Da Vinci**  
1452-1519



**André-Marie Ampère**  
1775-1836



**Michael Faraday**  
1791-1867

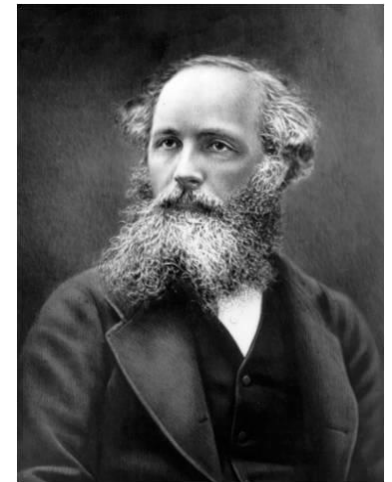

**James Clerk Maxwell**  
1831-1879



**Isaac Newton**  
1642-1727



**Carl Friedrich Gauss**  
1777-1855



**Georg Simon Ohm**  
1789-1854

# Maxwell 1865 and the Equations in His 1873 Treatise

VIII. *A Dynamical Theory of the Electromagnetic Field.* By J. CLERK MAXWELL, F.R.S.

Received October 27,—Read December 8, 1864.

## PART I.—INTRODUCTORY.

(1) THE most obvious mechanical phenomenon in electrical and magnetical experiments is the mutual action by which bodies in certain states set each other in motion while still at a sensible distance from each other. The first step, therefore, in reducing these phenomena into scientific form, is to ascertain the magnitude and direction of the force acting between the bodies, and when it is found that this force depends in a certain way upon the relative position of the bodies and on their electric or magnetic condition, it seems at first sight natural to explain the facts by assuming the existence of something either at rest or in motion in each body, constituting its electric or magnetic state, and capable of acting at a distance according to mathematical laws.

In this way mathematical theories of statical electricity, of magnetism, of the mechanical action between conductors carrying currents, and of the induction of currents have been formed. In these theories the force acting between the two bodies is treated with reference only to the condition of the bodies and their relative position, and without any express consideration of the surrounding medium.

These theories assume, more or less explicitly, the existence of substances the particles of which have the property of acting on one another at a distance by attraction or repulsion. The most complete development of a theory of this kind is that of M. W. WEBER\*, who has made the same theory include electrostatic and electromagnetic phenomena.

In doing so, however, he has found it necessary to assume that the force between two electric particles depends on their relative velocity, as well as on their distance.

This theory, as developed by MM. W. WEBER and C. NEUMANN†, is exceedingly ingenious, and wonderfully comprehensive in its application to the phenomena of statical electricity, electromagnetic attractions, induction of currents and diamagnetic phenomena; and it comes to us with the more authority, as it has served to guide the speculations of one who has made so great an advance in the practical part of electric science, both by introducing a consistent system of units in electrical measurement, and by actually determining electrical quantities with an accuracy hitherto unknown.

\* *Electrodynamische Maassbestimmungen.* Leipzig Trans. vol. i. 1849, and TAYLOR'S Scientific Memoirs, vol. v. art. xiv.

† “Explicare tentatur quomodo fiat ut lucis planum polarizationis per vires electricas vel magneticas declinetur.”—Halis Saxonium, 1858.

$$a = \frac{dH}{dy} - \frac{dG}{dz} \quad (A) \quad \text{Art. 591}$$

$$b = \frac{dF}{dz} - \frac{dH}{dx}$$

$$c = \frac{dG}{dx} - \frac{dF}{dy}$$

$$P = c \frac{dy}{dt} - b \frac{dz}{dt} - \frac{dF}{dt} - \frac{d\psi}{dx}$$

$$Q = a \frac{dz}{dt} - c \frac{dx}{dt} - \frac{dG}{dt} - \frac{d\psi}{dy} \quad (B) \quad \text{Art. 598}$$

$$R = b \frac{dx}{dt} - a \frac{dy}{dt} - \frac{dH}{dt} - \frac{d\psi}{dz}$$

$$X = vc - wb$$

$$Y = wa - uc$$

$$Z = ub - va$$

$$a = \alpha + 4\pi A$$

$$b = \beta + 4\pi B$$

$$c = \gamma + 4\pi C$$

$$4\pi u = \frac{d\gamma}{dy} - \frac{d\beta}{dz}$$

$$4\pi v = \frac{d\alpha}{dz} - \frac{d\gamma}{dx}$$

$$4\pi w = \frac{d\beta}{dx} - \frac{d\alpha}{dy}$$

$$\mathfrak{D} = \frac{1}{4\pi} K \mathfrak{E}$$

$$\mathfrak{K} = C \mathfrak{E}$$

$$\mathfrak{E} = \mathfrak{K} + \mathfrak{D}$$

$$u = p + \frac{df}{dt}$$

$$v = q + \frac{dq}{dt}$$

$$w = r + \frac{dh}{dt}$$

$$\mathfrak{E} = (C + \frac{1}{4\pi} K \frac{d}{dt}) \mathfrak{E}$$

$$u = CP + \frac{1}{4\pi} K \frac{dP}{dt}$$

$$v = CQ + \frac{1}{4\pi} K \frac{dQ}{dt}$$

$$w = CR + \frac{1}{4\pi} K \frac{dR}{dt}$$

$$\rho = \frac{df}{dx} + \frac{dq}{dy} + \frac{dh}{dz}$$

$$\sigma = lf + mg + nh + l'f' + m'g' + n'h' \quad (J) \quad \text{Art. 612}$$

$$\mathfrak{B} = \mu \mathfrak{H} \quad (K) \quad \text{Art. 613}$$

$$\mathfrak{B} = \mu \mathfrak{H} \quad (L) \quad \text{Art. 614}$$

# The Maxwellians

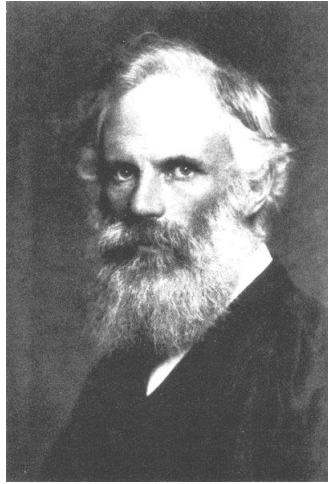

**George Francis FitzGerald**  
1851-1901

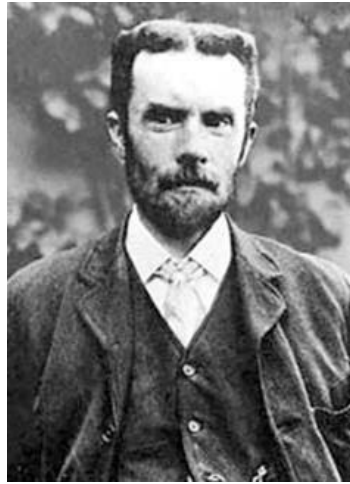

**Oliver Heaviside**  
1850-1925

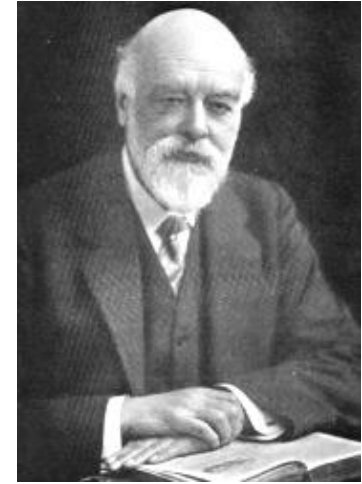

**Oliver Joseph Lodge**  
1851-1940



**Heinrich Rudolph Hertz**  
1857-1894

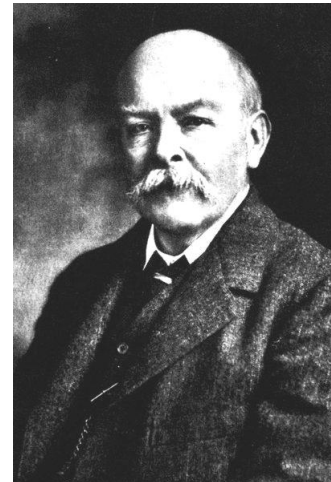

**John Henry Poynting**  
1851-1914

# Heaviside's "Duplex" Equations for Maxwell's Theory

$$\nabla \times \mathbf{E} = -\mathbf{M} - \frac{\partial \mathbf{B}}{\partial t}$$

$$\nabla \times \mathbf{H} = \mathbf{J} + \frac{\partial \mathbf{D}}{\partial t}$$

$$\nabla \cdot \mathbf{D} = \rho_e$$

$$\nabla \cdot \mathbf{B} = \rho_m$$

$$\mathbf{D} = \varepsilon \mathbf{E}$$

$$\mathbf{J} = \sigma_e \mathbf{E}$$

$$\mathbf{B} = \mu \mathbf{H}$$

$$\mathbf{M} = \sigma_m \mathbf{H}$$

“And God said, Let there be light; and there was light.” *Genesis 1:3*

# Pre-History of Antennas

- 1785** Coulomb's Law is published – C-A. de Coulomb
- 1812** Poisson's Equation is published – S.D. Poisson
- 1813** Gauss's Divergence Theorem – C.F. Gauss or M.V. Ostrogradskii
- 1820** Discovery that electric current makes magnetic effects (field concept not yet articulated) – H.C. Øersted
- 1820** Discovery that electricity and magnetism are linked phenomena – André-Marie Ampère
- 1820** Biot-Savart Law discovered – J-B. Biot & P. Savart
- 1826** Ampère's Law is published – André-Marie Ampère
- 1831** Faraday's Law is published – M. Faraday
- 1842** Discovery of radiation – J. Henry
- 1856** "On Faraday's Lines of Force" – J.C. Maxwell
- 1861** "On Physical Lines of Force" – J.C. Maxwell
- 1865** "A Dynamical Theory of the Electromagnetic Field" – J.C. Maxwell
- 1873** *A Treatise on Electricity and Magnetism* – J.C. Maxwell
- 1879-94** The "Maxwellians" period – O. Heaviside, G.F. FitzGerald, O.J. Lodge

# Key Dates in Antennas

---

- 1875-87** Early radiation demonstrations: T.A. Edison 1875; A.E. Dolbear 1882; H. Hertz 1887
- 1889-06** Phased arrays – A. Artom, S.G. Brown, J.E. Murray
- 1895-01** Radio communication, fan dipole, polar plots – G. Marconi
- 1897** Biconical dipole, loading coil, tunable *LC* matching network, counterpoise, “impedance” – O.J. Lodge
- 1907** Goniometer, electrical steerable array, radio direction-finding – E. Bellini and A. Tosi
- 1907** Ground losses, ground waves – J. Zenneck
- 1909-26** Infinite half-space problem – A.N. Sommerfeld
- 1919** Trees as antennas – G.O. Squier
- 1923** Wave-tilt antenna – H.H. Beverage
- 1928** Endfire array with parasitic elements – H. Yagi and S. Uda
- 1934-37** Radials, ground currents and losses – G.H. Brown
- 1940** Albert Einstein popularizes the name “Maxwell’s Equations”
- 1947** Polyrod antenna – G.E. Mueller and W.L. Tyrell
- 1947-75** Small antennas – H. Wheeler



# Key Dates in Antennas continued

- 1948** Fundamental limit on antenna bandwidth – L.J. Chu
- 1950** *Antennas* – J.D. Kraus
- 1952** *Antennas: Theory and Practice* – S.A. Schelkunoff and H.T. Friis
- 1952** *Advanced Antenna Theory* – S.A. Schelkunoff
- 1956** *Theory of Linear Cylindrical Antennas* – R.W.P. King
- 1959** “Method of moments” – A.V. Kantorovich, G.P. Akilov
- 1961** *Antenna Engineering Handbook* – H. Jasik
- 1966** Finite difference method for fields problems – K.S. Yee
- 1967** Matrix methods for fields problems – R.F. Harrington
- 1974** Vivaldi antenna – L.R. Lewis, M. Fasset, M. Hunt
- 1976** Landstorfer antenna – F.M. Landstorfer
- 2003** Metamaterial radomes – R.W. Ziolkowski and A.D. Kipple
- 2006** *Electrically Small, Superdirective, and Superconducting Antennas* – R.C. Hansen
- 2016** *Antenna Theory*, 4<sup>th</sup> edition – C.A. Balanis

# Antenna Analysis

- **Methods for finding impedance without solving for the current distribution**
  - Assume sinusoidal – induced EMF method (Brillouin, 1922)
  - Assume thin bicone – radial transmission line (Schelkunoff, 1941)
  - Far field radiation pattern integration (Rhodes, 1964; Hill, 1967)
- **Methods for finding current distribution and impedance**
  - Solve Pocklington's (1897) integral equation
  - Solve Hallen's (1938) integral equation
  - Mathematical methods (asymptotic or variational)
    - King-Harrison (*Proc. IRE*, 1943)
    - Middleton-King (*J. Appl. Phys.*, 1946)
    - Storer (Cruft Lab., Harvard, 1950)
    - Tai (*IEEE Trans. Antennas and Propagation*, 1955)
- **Limitations and complications**
  - Not all antennas shapes are simple
  - Not all antennas are made of metal; dielectrics affect radiation too
  - Math is hard

# Induced EMF Method

- L. Brillouin, *Radioélectricité*, April 1922
- A.A. Pistolkors, *Proc. IRE*, March 1929
- P.S. Carter, *Proc. IRE*, June 1932
- Assume sinusoidal current distribution
- Obtain pattern, radiation resistance and reactance
- Accurate for pattern and impedance of dipoles up to half-wavelength and verticals up to quarter-wavelength
- Inaccurate for impedance of dipoles longer than half-wavelength and verticals longer than quarter-wavelength
- Widely used for the design of AM broadcast towers
- Obsoleted by numerical methods

*Proceedings of the Institute of Radio Engineers*  
Volume 20, Number 6 June, 1932

## CIRCUIT RELATIONS IN RADIATING SYSTEMS AND APPLICATIONS TO ANTENNA PROBLEMS\*

BY

P. S. CARTER

(R.C.A. Communications, Inc., Rocky Point, L. I., N.Y.)

*Summary*—Expressions for the self and mutual impedances within a radiating system are developed by the use of the generalized reciprocity theorem. These expressions are given in terms of the distributions of the electric field intensities along the radiators.

A method for the determination of the field intensities is outlined. Formulas for the self and mutual impedances in several types of directional antennas are given.

Questions of practical interest in connection with arrays of half-wave dipoles, long parallel wires, and "V" type radiators are discussed. Different types of reflector systems are considered. Curves of the more important relations are shown.

The mathematical development is shown in an appendix.

IN THE design and the adjustment of antenna systems a knowledge of certain characteristics and relations is of great assistance.

We should know the theoretical directivity, that is, the ratio of the intensity of radiation in a desired direction to the mean intensity in all directions. The contribution of each radiating element to the total radiated power and the interactions between elements are important. In a good system the ratio of heat losses to radiated power must be low.

The intensity of radiation in the desired direction is relatively easy to obtain. To determine the total power we may, for mathematical purposes, imagine the system placed at the center of a very large sphere and compute the power flow through each element of area on the sphere. A summation gives the total. The average intensity is then this total divided by the number of units of solid angle contained in the sphere. The application of this method to long linear radiators and several types of directional antenna systems has been shown by the writer in detail.<sup>1</sup> Upon completion of this process we have a complete knowledge of the power flow in every direction in space but are left in entire ignorance as to the portions of this power contributed by the various antenna elements and as to the interactions between these elements.

To the communications engineer, who is quite familiar with the use of impedance operators in connection with ordinary circuit calcula-

\* Decimal classification: R116. Original manuscript received by the Institute, March 1, 1932. Presented before Twentieth Anniversary Convention of the Institute, Pittsburgh, Pa., April 9, 1932.

<sup>1</sup> Carter, Hansell, Lindenblad, "Development of directive transmitting antennas by R.C.A. Communications, Inc.," *Proc. I.R.E.*, vol. 19, pp. 1773-1842; October, (1931).

1004

# Dipole Impedance via Induced EMF Method

- Resistance

$$R_{in} = \frac{\eta}{4\pi \sin^2(kl)} \left\{ 2\gamma + 2\ln(2kl) - 2\text{Ci}(2kl) + \sin(2kl) [\text{Si}(4kl) - 2\text{Si}(2kl)] + \cos(2kl) [\text{Ci}(4kl) - 2\text{Ci}(2kl) + \gamma + \ln(kl)] \right\}$$

Terms vanish when  $l / \lambda$  is a half integer; impedance is independent of wire diameter for such lengths

- Reactance

$$X_{in} = \frac{\eta}{4\pi \sin^2(kl)} \left\{ 2\text{Si}(2kl) - \cos(2kl) [\text{Si}(4kl) - 2\text{Si}(2kl)] + \sin(2kl) \left[ \text{Ci}(4kl) - 2\text{Ci}(2kl) + \gamma + \ln\left(\frac{ka^2}{l}\right) \right] \right\}$$

$L = 2l =$  dipole total length

$l =$  dipole half length

$a =$  wire radius

Wire radius affects only reactance

- Accurate for dipoles in free space of length less than  $\lambda/2$ ; not accurate for longer dipoles

# Dipole Impedance by Tai-Elliott Equation

- Resistance

$$R_{in} = -0.4787 + 7.3246kl + 0.3963(kl)^2 + 15.6131(kl)^3$$

- Reactance

$$X_{in} = -\frac{\eta}{\pi} \left( \ln\left(\frac{l}{a}\right) - 1 \right) \cot kl + \left( -0.4456 + 17.0082kl - 8.6793(kl)^2 + 9.6031(kl)^3 \right)$$

Wire radius affects  
only reactance

$L = 2l$  = dipole total length  
 $l$  = dipole half length  
 $a$  = wire radius

- Accuracy is  $\pm 0.5$  ohm for a dipole in free space shorter than  $\lambda/2$
- Not accurate for longer dipoles

# Integral Equations for the Current Along a Wire

- Pocklington's equation (1897)

$$\int_{-l}^l I_z(z') \left[ \left( \frac{\partial^2}{\partial z'^2} + k^2 \right) G(z, z') \right] dz' = -j\omega\epsilon E_z^i(\rho = a)$$

- Hallen's equation (1938)

$$\int_{-l}^l I_z(z') \frac{e^{-jkR}}{4\pi R} dz' = -j \sqrt{\frac{\epsilon}{\mu}} [B_1 \cos(kz) + C_1 \sin(k|z|)]$$

- General form

$$\text{Linear operator} \rightarrow L(f) = g \leftarrow \text{Driving function}$$

Unknown function

# Ronold Wyeth Percival King, 1905-2006

---



**R.W.P. King, Harvard University authority on linear cylindrical antennas, speaking at his 100<sup>th</sup> birthday party, Oct. 2005**

# Resistance of Dipole, $L = 98.4$ ft., $L / d = 11,013$

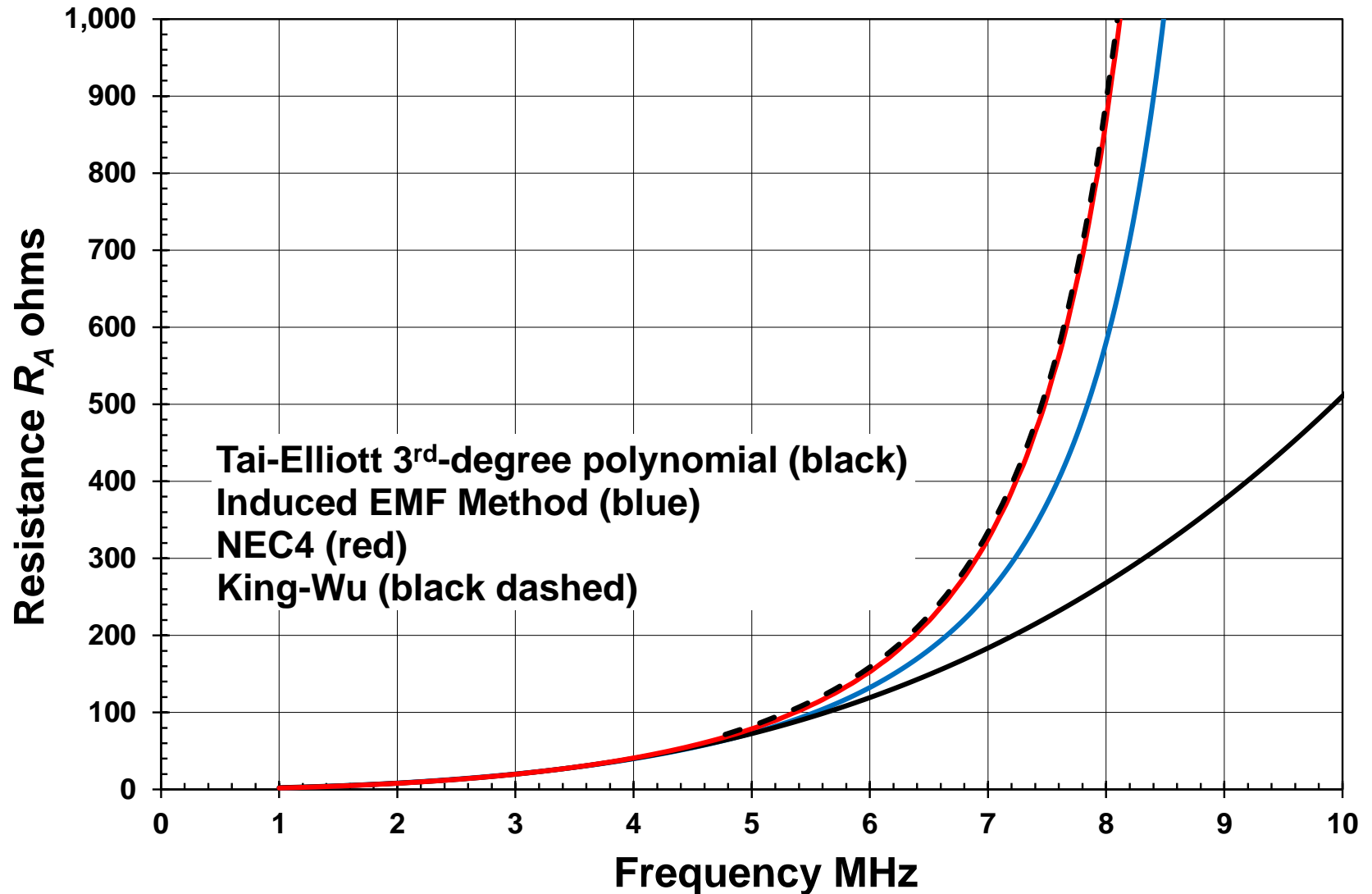



# Reactance of Dipole, $L = 98.4$ ft., $L / d = 11,013$

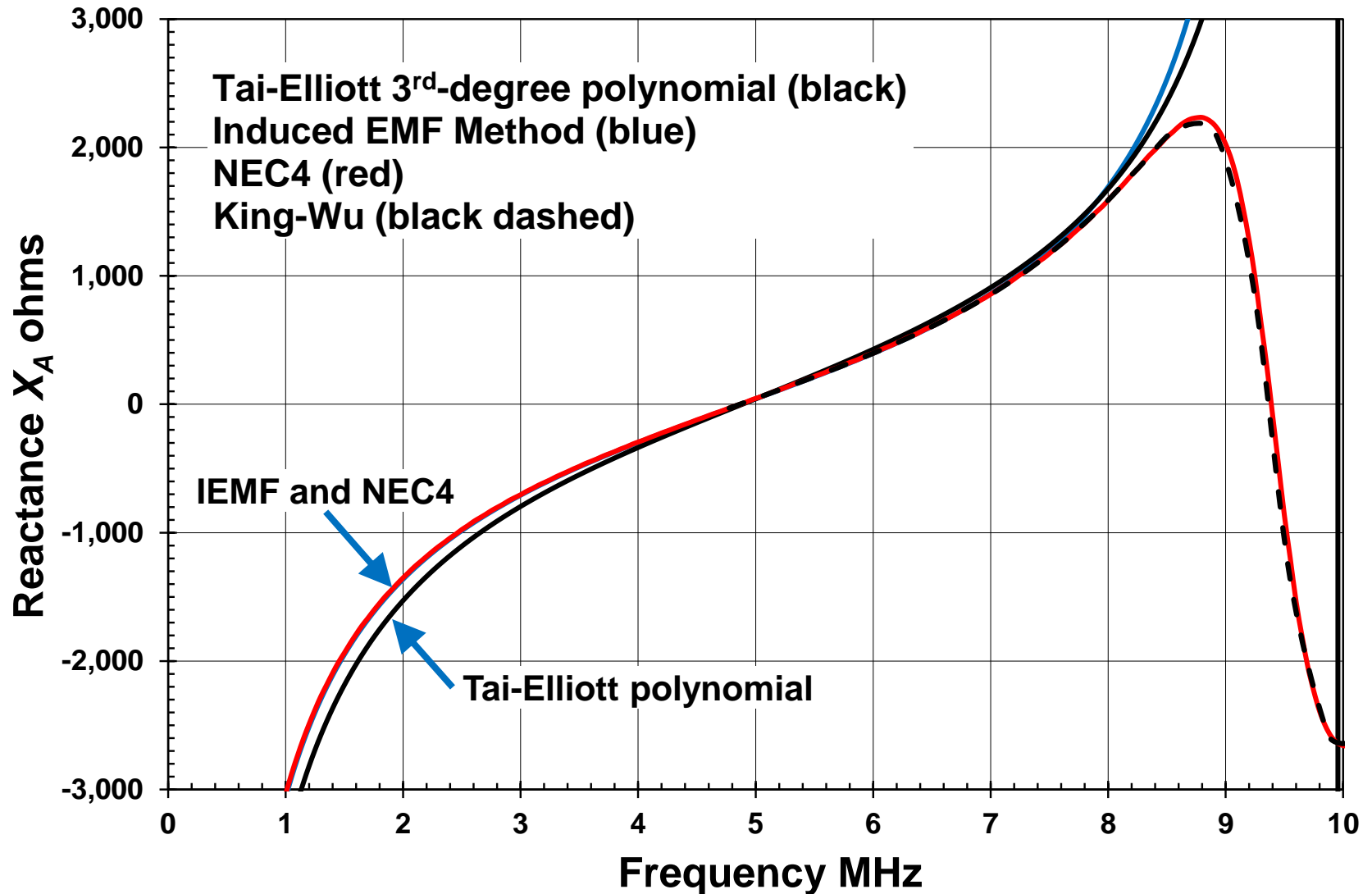

# Electric and Magnetic Fields of an Infinitesimal Dipole

- Fields of dipole source in free space, or monopole over perfect electrical conductor (PEC) plane

$$H_r = H_\theta = 0$$

$$H_\phi = j \frac{k I_0 l \sin \theta}{4\pi r} \left[ 1 + \frac{1}{jkr} \right] e^{-jkr}$$

$$E_r = \eta \frac{k I_0 l \cos \theta}{4\pi r} \left( \frac{2}{kr} \right) \left[ 1 + \frac{1}{jkr} \right] e^{-jkr}$$

$$E_\theta = j\eta \frac{k I_0 l \sin \theta}{4\pi r} \left[ 1 + \frac{1}{jkr} - \frac{1}{(kr)^2} \right] e^{-jkr}$$

$$E_\phi = 0$$

Near field terms assuming

- Uniform current distribution with
  - Current  $I_0$
  - Dipole length  $l$
- Triangular current distribution with
  - Peak current  $I_0$
  - Dipole length  $2l$

One radianlength defined as  $r = 1/k = \lambda/2\pi$  is the distance at which far field and near field terms are equal.

# Heinrich Hertz's Drawings of Electric Fields of a Dipole circa 1888

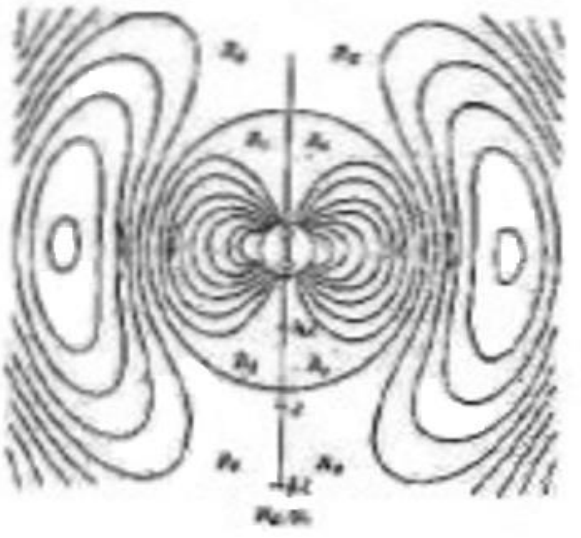
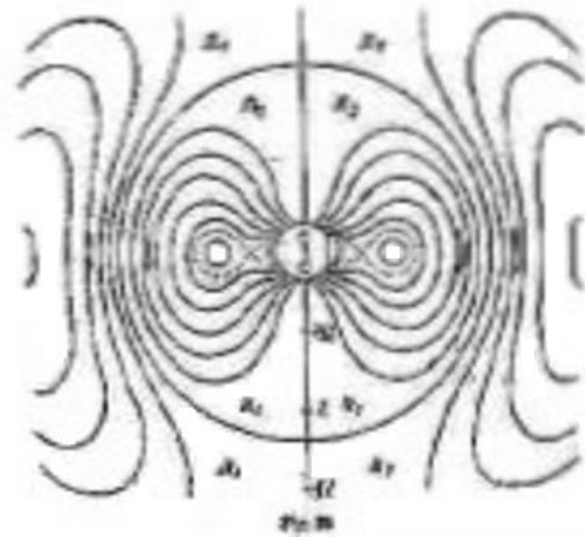
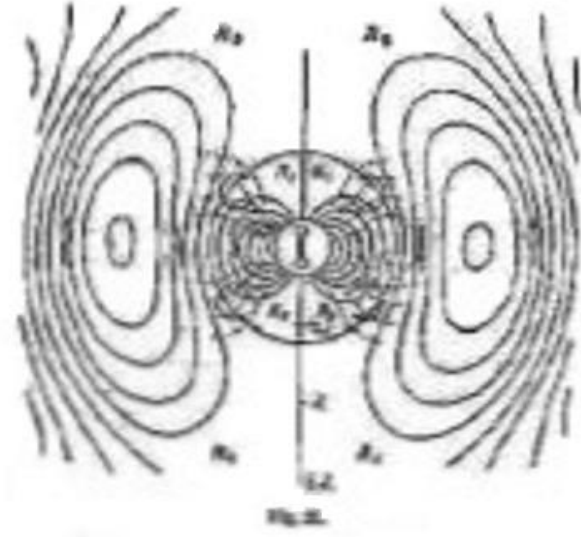
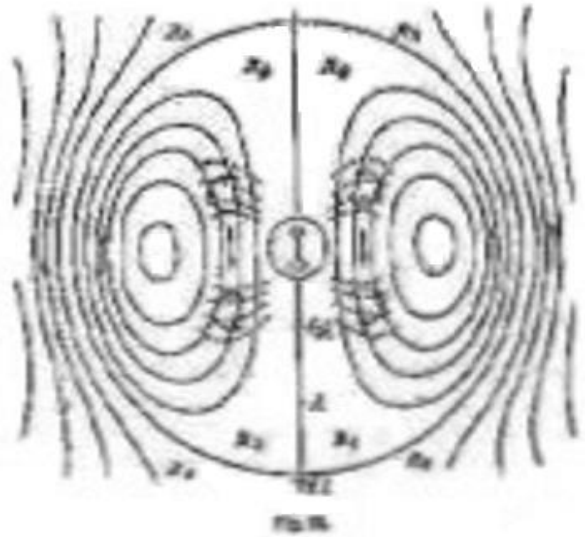

# Generation of Dipole Fields

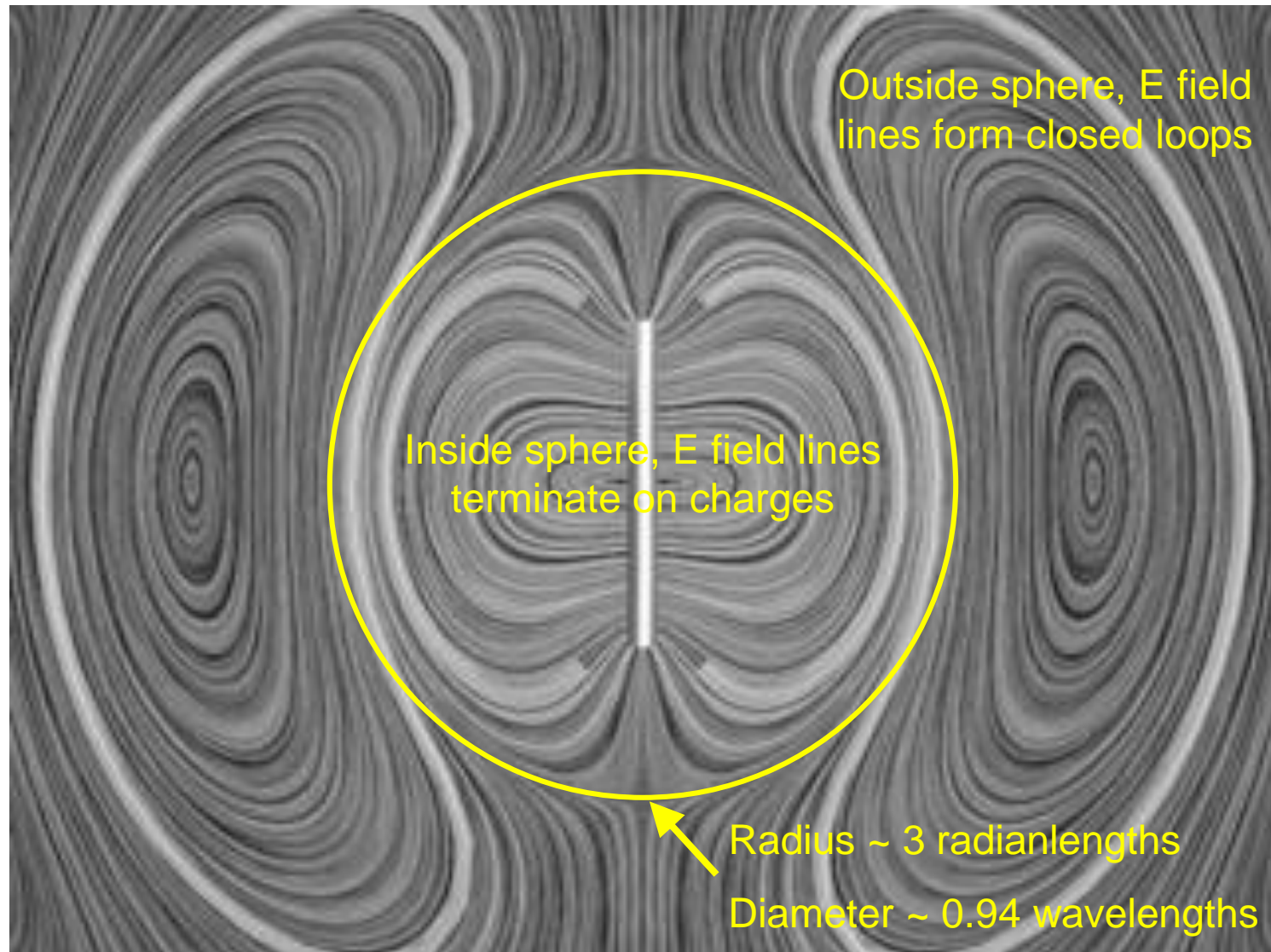

# Dipole Fields Animations

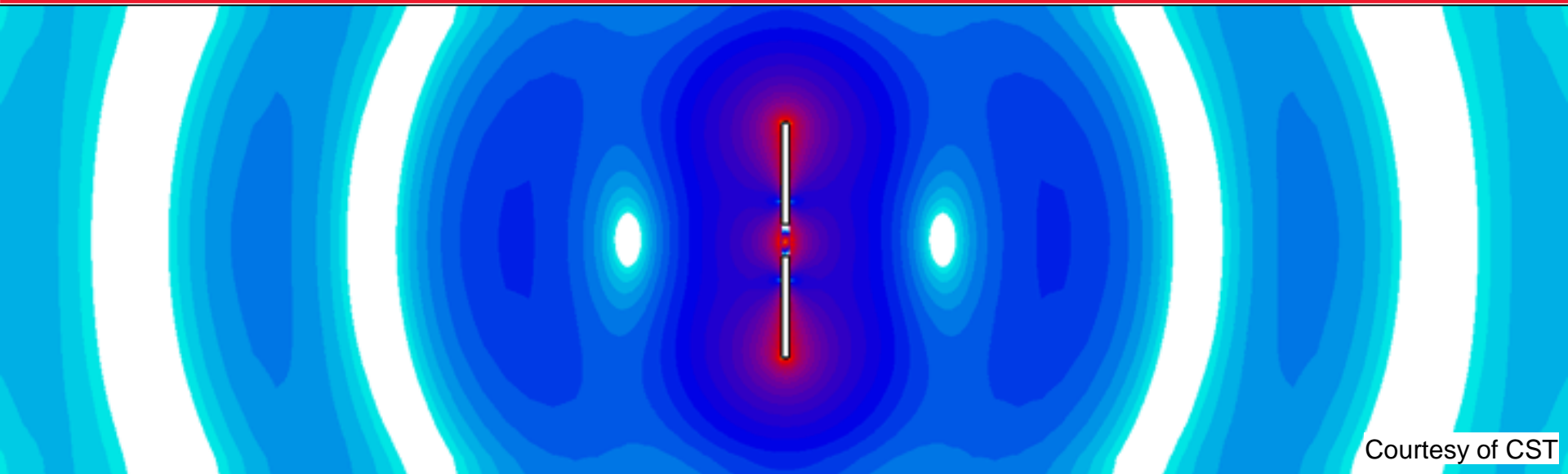

Courtesy of CST

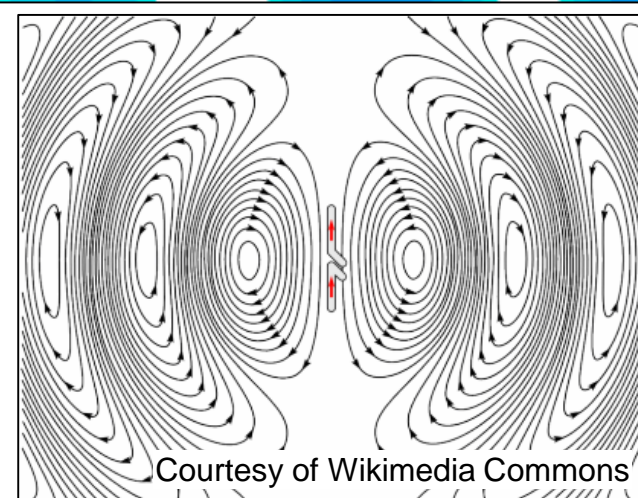

Courtesy of Wikimedia Commons

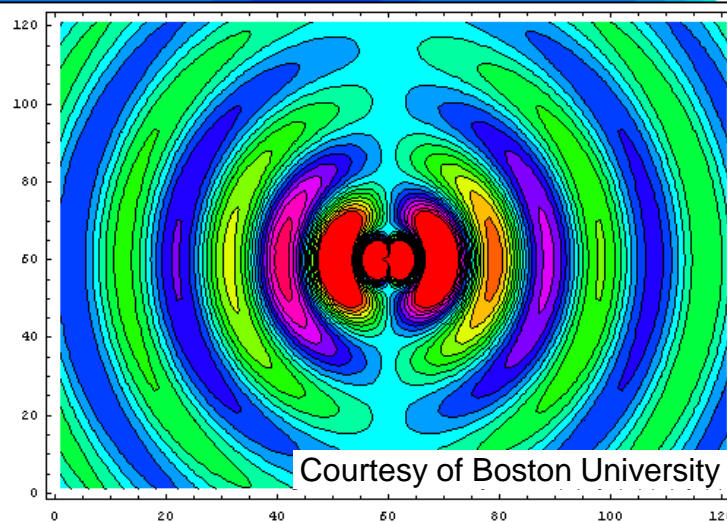

Courtesy of Boston University

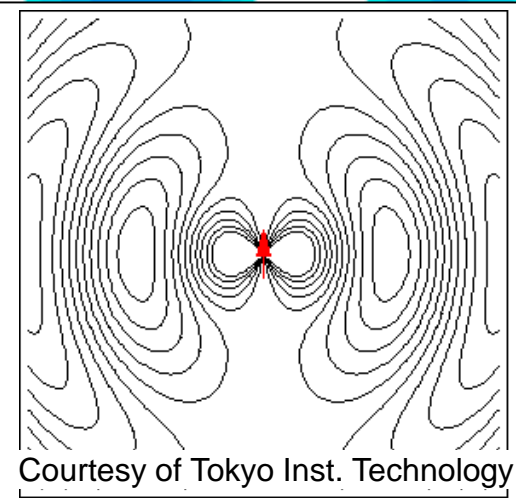

Courtesy of Tokyo Inst. Technology

View PowerPoint in Slide Show mode (Shift F5) to see field animations.

# Poynting Vector of Infinitesimal Dipole

$$\mathbf{S} = \frac{1}{2} \mathbf{E} \times \mathbf{H}^* = \mathbf{a}_r S_r + \mathbf{a}_\theta S_\theta + \mathbf{a}_\phi 0$$

$$S_r = \frac{1}{2} (E_\theta H_\phi^* - E_\phi H_\theta^*) \quad \text{Real power}$$

$$= \frac{\eta \sin^2 \theta}{2} \left( \frac{k I_0 l}{4\pi r} \right)^2 \left( 1 - \frac{j}{(kr)^3} \right)$$

$$S_\theta = \frac{1}{2} (E_r H_\phi^* - E_\phi H_r^*) \quad \text{Reactive power}$$

$$= -j \frac{\eta \sin 2\theta}{4} \left( \frac{k I_0 l}{4\pi r} \right)^2 \left( 1 + \frac{1}{(kr)^2} \right)$$

$$S_\phi = \frac{1}{2} (E_r H_\theta^* - E_\theta H_r^*) = 0$$

- Power flow has real and reactive parts
- Real power flows radially outward from the origin
- Reactive power circulates in the near field
- But the power in the far field is not just real
- The theta component of the power flow survives into the far field and is reactive
- Does the far field have stored energy, like the near field?

---

# Computational Electromagnetics

# Evolution of Tools and Methods for Antennas

- **Old style antenna analysis (1880 to 1970)**
  - Used mathematics, slide rules, nomographs, desk top calculators, lab measurements and field testing
  - Limited to simple geometries, and few antenna properties
    - Impedance
    - Far fields
- **Modern antenna analysis (1970 to present)**
  - Uses sophisticated computational electromagnetics (CEM) computer codes, aka antenna modeling software, and less dependence on measurement
  - Results validated by agreement among different algorithms
  - Allows for evaluation of complicated geometries, materials, and more antenna properties
    - Radiation pattern for each field or polarization
    - Polarization
    - Efficiency
    - Near fields
    - Specific absorption rate (SAR)
    - Mutual coupling between antennas in an array
    - Scattering and radar cross-section



# The Universe of Antenna Modeling Methods

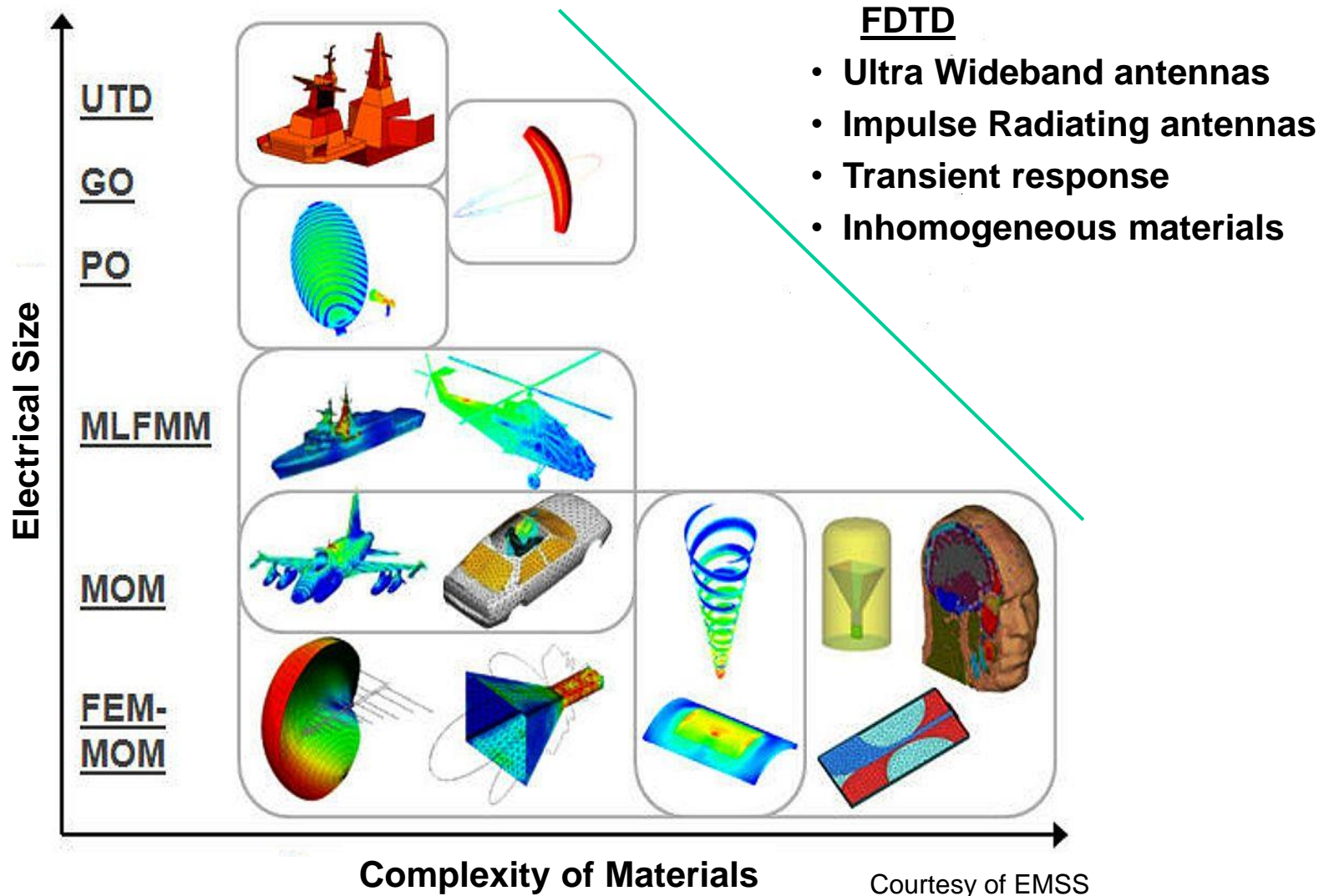

# Computational Electromagnetics

- **Method of moments (MoM)**

- A method for solving integro-differential equations such as Hallen's or Pocklington's equation at a frequency
- Earliest and longest legacy of software codes for antenna modeling
- BRACT, WIRA, AMP, NEC, NEC2, NEC3, NEC4, MININEC, ELNEC, EZNEC, winNECPlus, 4nec2, Mentor Graphics (Zeland) IE3D, Altair (EMSS) FEKO, WiPL-D, HOBBIES

- **Finite element method (FEM)**

- Best for design of small antennas of complex structure
- ANSYS (Ansoft) HFSS

- **Finite difference time-domain method (FDTD)**

- Pioneered by K.S. Yee 1966 and A. Taflove 1980
- Best for design of small antennas for wide bandwidth applications
- Dassault Systèmes (CST) Microwave Studio, Remcom XFDTD, Faustus MEFiSTo, openEMS

- **Geometric, physical, and uniform theories of diffraction**

- Best for electrically-large antennas and radiating structures
- ANSYS (Delcross) Savant

---

# The Method of Moments

# Originators



**I.G. Bubnov**  
1872-1919



**Leonid Vitaliyevich Kantorovich**  
1912-1986



**Jack H. Richmond**  
1922-1990



**Boris Grigoryevich Galerkin**  
1871-1945

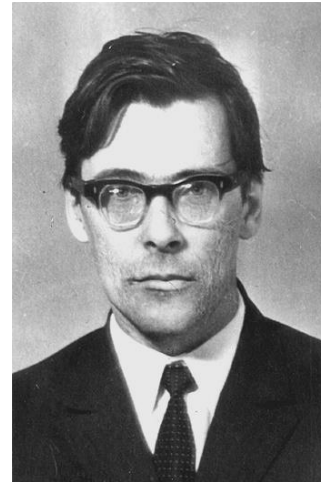

**Gleb Pavlovich Akilov**  
1924-1964



**Roger F. Harrington**  
1925-

# Method of Moments

- **Published by Kantorovich and Akilov in 1959 as a general method for solving linear integro-differential equations**
- **Introduced into electromagnetics by Roger Harrington in 1967**
  - Currents are weighted sum of basis functions
  - Solve for the coefficients of the basis functions for all segments
  - Calculate radiation pattern and feedpoint impedance from currents
- **Uses two classes of functions, which may be the same or different**
  - Basis functions and Test functions
  - Can be global or local (subsectional)
  - Global basis functions expand the current on a wire in an infinite series, e.g. Fourier series
  - Local basis functions divide an antenna into line segments, surface patches, or volume elements
- **Subsectional basis functions appear to give better results solving Hallen's equation rather than Pocklington's**
- **Test functions are used to create "projections"**

# Integro-Differential Equations Made Simple

- Start with an equation. The problem is to find  $f$

$$L(f) = g$$

- Assume  $f$  can be expanded as a weighted sum of basis functions

$$L(f) = L\left(\sum_n a_n f_n\right) = g$$

- Set all projections (via test functions) of left and right sides equal

$$\sum_n a_n L(f_n \bullet \phi_m) = g \bullet \phi_m$$

- Write as a matrix equation of simultaneous linear equations

$$\begin{bmatrix} L(f_1 \bullet \phi_1) & \cdots & L(f_N \bullet \phi_1) \\ \vdots & \ddots & \vdots \\ L(f_1 \bullet \phi_M) & \cdots & L(f_N \bullet \phi_M) \end{bmatrix} \begin{bmatrix} a_1 \\ \vdots \\ a_N \end{bmatrix} = \begin{bmatrix} g \bullet \phi_1 \\ \vdots \\ g \bullet \phi_M \end{bmatrix}$$

# The Solution

- Solve for the vector of expansion coefficients

$$\begin{bmatrix} a_1 \\ \vdots \\ a_N \end{bmatrix} = \begin{bmatrix} L(f_1 \bullet \phi_1) & \cdots & L(f_N \bullet \phi_1) \\ \vdots & \ddots & \vdots \\ L(f_1 \bullet \phi_M) & \cdots & L(f_N \bullet \phi_M) \end{bmatrix}^{-1} \begin{bmatrix} g \bullet \phi_1 \\ \vdots \\ g \bullet \phi_M \end{bmatrix}$$

- Obtain  $f$

$$f = \sum_n a_n f_n = \begin{bmatrix} f_1 & \cdots & f_N \end{bmatrix} \begin{bmatrix} L(f_1 \bullet \phi_1) & \cdots & L(f_N \bullet \phi_1) \\ \vdots & \ddots & \vdots \\ L(f_1 \bullet \phi_M) & \cdots & L(f_N \bullet \phi_M) \end{bmatrix}^{-1} \begin{bmatrix} g \bullet \phi_1 \\ \vdots \\ g \bullet \phi_M \end{bmatrix}$$

# Meshing

- **1D segments**
- **2D patches**
  - Flat rectangles
  - Flat quadrilaterals
  - Flat triangles
  - Curved (bilinear) quadrilaterals
- **3D voxels**
  - Cubic or hexahedral
  - Tetrahedral
- **Manually specified meshing**
- **Automatic meshing**
- **Adaptive (smart) meshing**

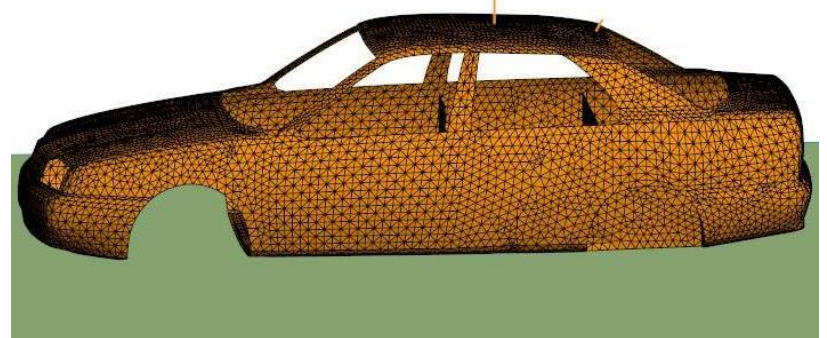
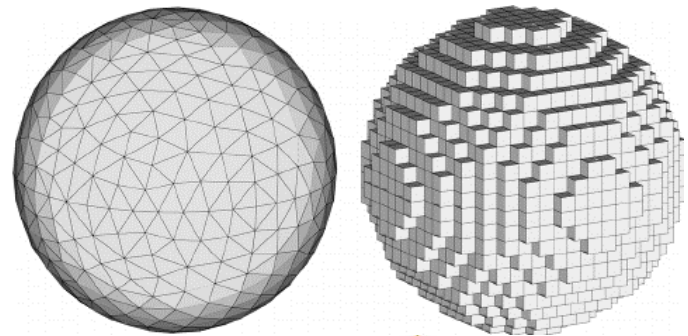
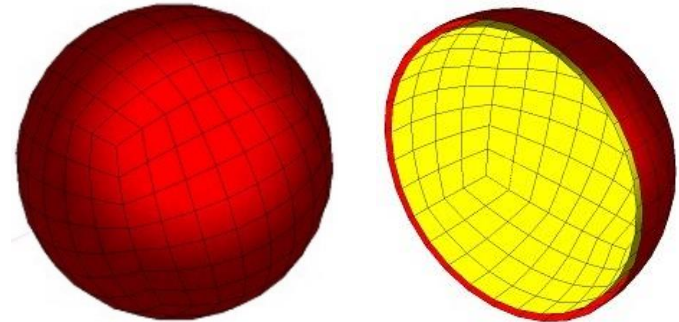



# Principal MoM Computer Codes

- **WIRA** – Developed late 1960s by M. Andreasen, F. Harris and R. Tanner at Technology for Communications International (TCI)
- **BRAC T & ANTBRAC T** – Developed late 1960s at MBAssociates, San Ramon, CA
- **AMP/AMP2** – Developed mid 1970s by G.J. Burke at MBAssociates, San Ramon
- **NEC (1979)** – Added more accurate current expansions; multiple wire junctions; thick wires
- **NEC-BSC (1980)** – Added Basic Scattering Code of J. Richmond at Ohio State
- **MiniNEC (1980)** – Developed by J. Rockway and J. Logan. Different algorithms from NEC. Basis of MMANA-GAL.
- **NEC2 (1981)** – Sommerfield-Norton ground interaction for wire structures above lossy ground; numerical Green's function allows modifying without repeating whole calculation
- **NEC3 (1985)** – Buried wires
- **NEC4 (1992)** – Improved accuracy for stepped-radius wires and electrically-small segments, end caps and insulated wires, catenary-shaped wires, improved error detection
- **Zeland IE3D (1992)** – Adaptive meshing, developed by J-X. Zheng, Zeland Software, Fremont, CA. Acquired by Mentor Graphics in 2010.
- **FEKO (ca 2000)** – Hybrid method developed by U. Jakobus at EMSS, Stellenbosch, South Africa. Acquired by Altair in 2014.
- **WiPL-D (ca 2000)** – Advanced MoM for wires, plates, and dielectrics based on work of A.R. Djordjevic, B.M. Kolundzija, University of Belgrade, Serbia
- **HOBBIES (2010)** – Similar to WiPL-D except has out-of-core solver. Developed by T.K. Sarkar, Syracuse University, New York, sponsored by U.S. DoD

# The History of NEC

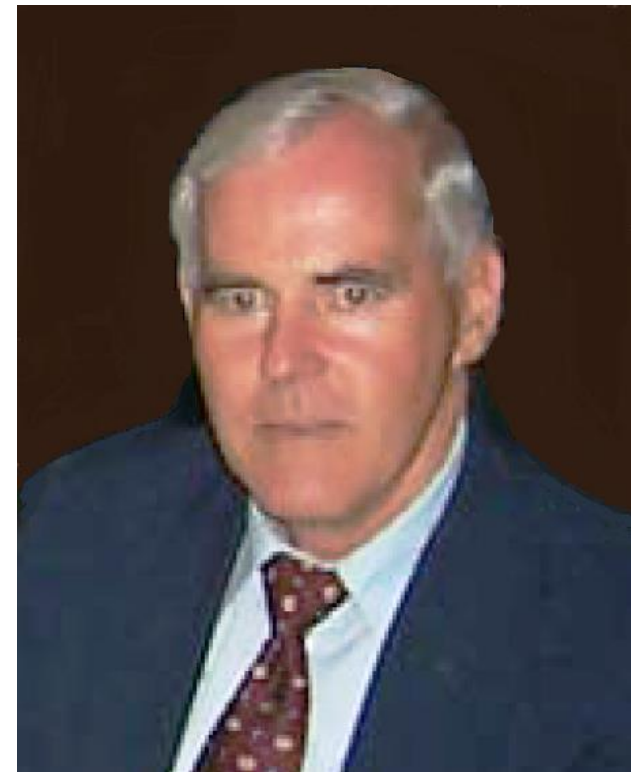
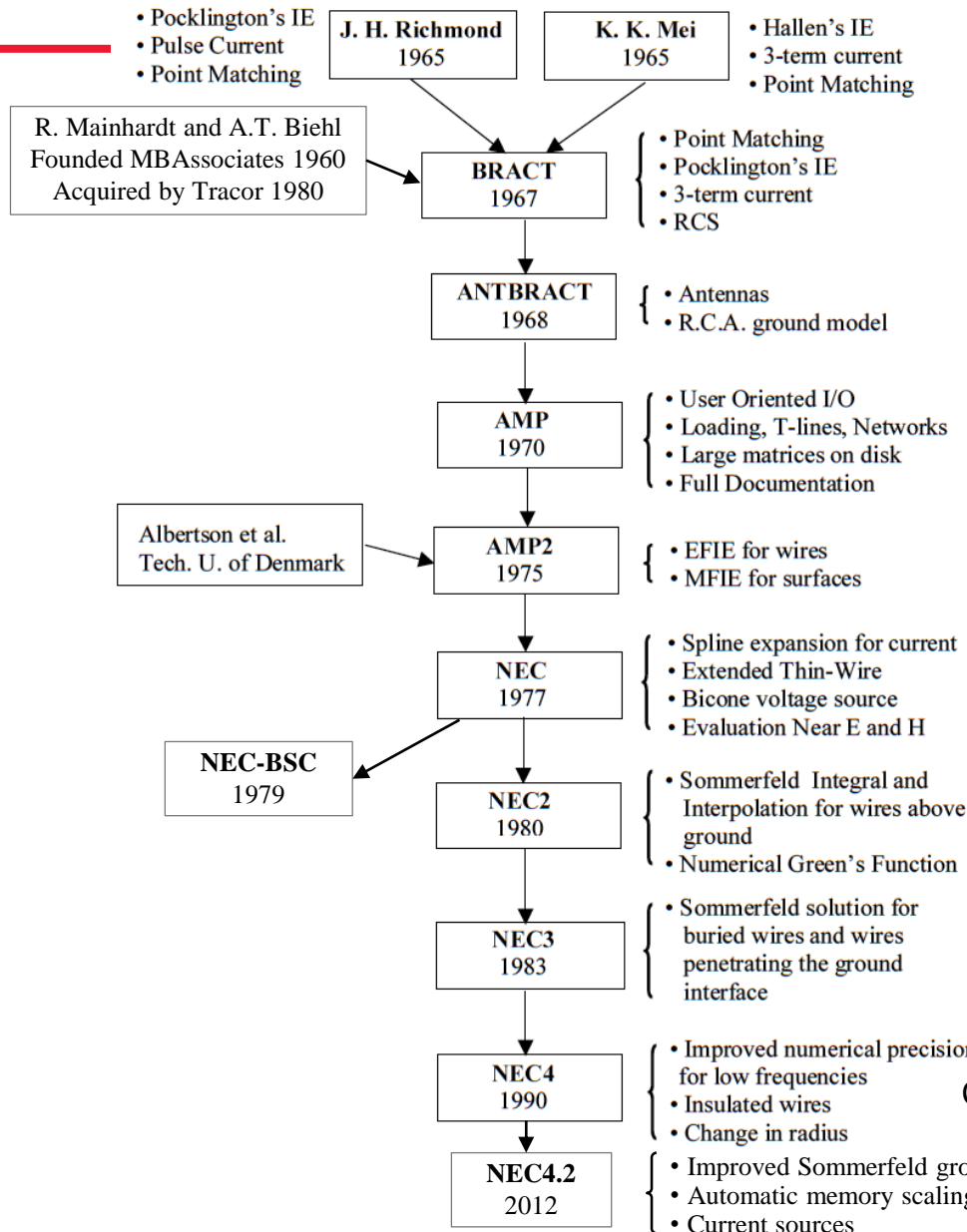

**Gerald J. Burke**

Courtesy of Applied Computational Electromagnetics Society

# A More Accurate "Thin-Wire" Code

- Multiradius Bridge Current (MBC) method
- Developed by M.A. Tilston 1983-89 while at Univ. of Toronto
- Better accuracy than NEC4 when wires are very close to other wires or ground or join at acute angles, e.g. wire grid models of surfaces
- Used commercially by Phoenix Antenna Systems in Perth, Ontario, Canada
- Fortran source code

1636

IEEE TRANSACTIONS ON ANTENNAS AND PROPAGATION, VOL. 38, NO. 10, OCTOBER 1990

## A Multiradius, Reciprocal Implementation of the Thin-Wire Moment Method

MARK A. TILSTON, MEMBER, IEEE, AND KEITH G. BALMAIN, FELLOW, IEEE

**Abstract**—An implementation of the moment method for electromagnetic analysis of multiradius thin-wire structures, including multiwire, multiradius junctions is presented. It is entitled the multiradius bridge-current (MBC) moment method. It is an extension of the authors' uniradius bridge-current reformulation of Richmond's uniradius thin-wire theory. The method features an exactly symmetric mutual impedance matrix ensuring reciprocity between sources, it is unconstrained with respect to both the length ratio and the radius ratio of adjoining segments provided that the wires are electrically thin, and it permits the self-consistent inclusion of coaxial-cable sections in the configuration under analysis. The method is validated through comparison with transmission-line theory for a two-wire line and a coaxial cable, and through comparison with measurements on a sleeve monopole antenna and a log-periodic dipole antenna. Finally, the MBC moment method program is shown to surpass the Numerical Electromagnetics Code (NEC) in terms of reciprocity and convergence for both an AM broadcast tower detuning stub problem and a bent two-wire transmission-line problem.

### I. INTRODUCTION

A WELL-KNOWN moment method computer program for the electromagnetic analysis of uniradius thin-wire structures is that of Richmond [1]. It has been shown by Butler and Wilton [2] that the particular method of expansion and testing, which they term "Pocklington piecewise-sinusoid Galerkin," is one of the best methods for obtaining rapid convergence in the solution. Although very useful, Richmond's program can display asymmetric artifacts when used to analyze certain symmetric structures, a problem that was observed by Vainberg and Balmain [3], explained and corrected approximately by Hilbert, Tilston, and Balmain [4], and finally corrected more completely by the authors in their "bridge-current" formulation [5]. In the present work, the bridge-current formulation is extended to allow solution of the multiradius problem.

### II. DESCRIPTION OF BRIDGE-CURRENT MOMENT METHOD VERSIONS

#### A. Uniradius Bridge-Current Version

The uniradius bridge-current version forms the starting point for the multiradius bridge-current version. The unira-

dius version is described in detail in [5], and is described here briefly because it is necessary in order to explain the multiradius version.

The wire structure to be modeled consists of straight wire segments all of the same radius, and usually shorter than a quarter-wavelength. Conceptually, a current expansion function is a tubular dipolar current spanning the surface of two adjoining wire segments that are not necessarily collinear. Each expansion function has a corresponding identical tubular testing function, in a coincident location. The current on each segment is axially directed, sinusoidally distributed, continuous at the segment junction, and zero at the other end of each segment. The total current at the junction is unity. The mutual impedance between a tubular expansion dipole and a tubular testing dipole is composed of four tubular-monopole-to-tubular-monopole mutual impedances.

The mutual impedance between a tubular expansion monopole and a tubular testing monopole is approximated by the mutual impedance between two filamentary monopoles that are placed on their respective segment axes unless the axes intersect or coincide. If the axes coincide, the expansion monopole is offset by a wire radius in a direction orthogonal to the coincident axes. If the two axes intersect, the expansion monopole is offset by a wire radius in a direction orthogonal to the plane containing both axes.

Now consider one testing monopole and two expansion monopoles that form an expansion dipole. With certain geometries, the filamentary expansion monopoles may be offset from their segment axes in different directions, thus forming a dipole that is broken at its vertex. This would occur, for example, if the segment axis of one, and only one, of the two expansion monopoles was coplanar with (but not parallel to) that of the testing monopole. In such a case, the break is bridged by a straight, uniformly distributed "bridge current." With this geometry, the bridge current is orthogonal to the testing monopole. Because of this orthogonality, and because of its uniform current distribution, the bridge current does not contribute to the following symmetric integral form for the mutual impedance  $Z_{ab}$  between a filamentary testing monopole  $a$  and a bridged filamentary expansion dipole  $b$  [5]:

$$Z_{ab} = j\omega \iint \left[ \frac{\mu}{4\pi} \mathbf{J}_a(\mathbf{r}) \cdot \mathbf{J}_b(\mathbf{r}') \right. \\ \left. + \frac{1}{4\pi\epsilon} \rho_a(\mathbf{r}) \rho_b(\mathbf{r}') \right] \frac{e^{-\gamma R}}{R} dV' dV \quad (1a)$$

where

$$R = |\mathbf{r} - \mathbf{r}'|, \quad (1b)$$

Manuscript received May 26, 1989; revised February 9, 1990. This work was supported by Bell Canada, by the Natural Sciences and Engineering Research Council, and by The Ontario Information Technology Research Centre.

M. A. Tilston was with the Department of Electrical Engineering, University of Toronto, Toronto, ON, Canada. He is now with M. A. Tilston Engineering, 90 Lawrence Avenue East, Toronto, ON, Canada M4N 1S6.

K. G. Balmain is with the Department of Electrical Engineering, University of Toronto, Toronto, ON, Canada M5S 1A4.

IEEE Log Number 9037639.

0018-926X/90/1000-1636\$01.00 © 1990 IEEE

# Le Roy Bruce (L.B.) Cebik, W4RNL, 1939-2008

---



**Popularized computational antenna modeling  
in Amateur Radio in the decade 1998-2008**

---

# **EZNEC**

# EZNEC <http://www.eznec.com>

- **Developed by Roy Lewallen, W7EL**
- **Now in version 6.0**
- **Five products available**
  - EZNEC v.6 Demo                      Free (20 segments, also runs ARRL models)
  - EZNEC v.6                                \$100 (500 segments)
  - EZNEC+ v.6                              \$150 (2,000 segments)
  - EZNEC Pro/2 v.6                        \$525 (45,000 segments)
  - EZNEC Pro/4 v.6                        \$675 (sold only to NEC4 licensees)
- **EZNEC includes either the NEC2 or NEC4 engines**
- **A NEC4 noncommercial user license can be obtained from Lawrence Livermore National Laboratory for \$300**
  - See <https://ipo.llnl.gov/technologies/nec>

# Key Parts of EZNEC

---

- **Specifying the antenna model**
  - Wire geometry (including radials)
  - Excitation sources
  - Wire loads
  - Transmission lines
  - Ground type and parameters
  - Frequency or sweep range
- **Specifying the desired outputs**
  - Radiation pattern cross-section at a given frequency
  - Gain in a specific direction
  - Pattern beamwidth
  - Front-to-back ratio
  - Front-to-rear ratio
  - Impedance
  - SWR
  - Output data files for other programs

# EZNEC v3 Main Screen and Control Panel

**EZNEC v. 3.0**

File Options Outputs Plot Setups View Utilities Help

**Discone for UHF TV**

>	File	Discone_UHF_TV_2.ez
>	<b>Frequency</b>	470 MHz.
	Wavelength	637.856 mm
>	<b>Wires</b>	33 Wires, 497 segments
>	<b>Sources</b>	1 Source
>	<b>Loads</b>	0 Loads
>	<b>Trans Lines</b>	0 Lines
>	<b>Ground Type</b>	Free Space
>	<b>Wire Loss</b>	Aluminum (6061-T6)
>	<b>Units</b>	Millimeters
>	<b>Plot Type</b>	3D
>	<b>Step Size</b>	2 Deg.
>	<b>Ref Level</b>	0 dBi
>	<b>Alt SWR Z0</b>	75 ohms

Average Gain = 1.571 = 1.96 dB

*Model contains loss*

*Model contains loss*



# Wires and Segments

- **Each wire in an antenna is defined by**
  - Location (coordinates) of both ends
  - Diameter or gauge of wire
  - Number of segments (all equal in length)
  - Metal type or conductivity

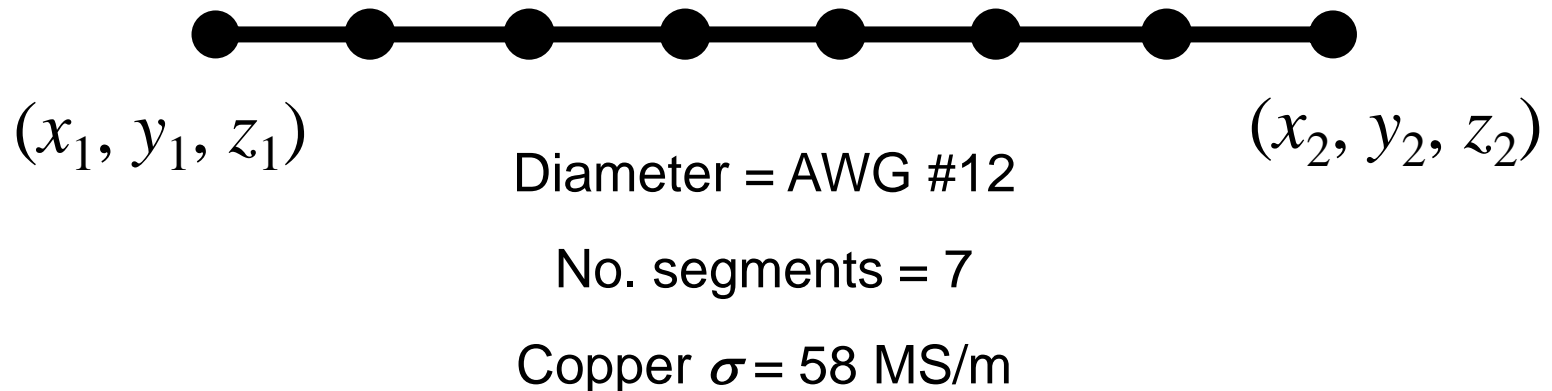

# Wire Table for UHF Discone Antenna

Wires										
Wire Other										
<input type="checkbox"/> Coord Entry Mode <input type="checkbox"/> Preserve Connections										
No.	End 1				End 2				Diameter (mm)	Segs
	X (mm)	Y (mm)	Z (mm)	Conn	X (mm)	Y (mm)	Z (mm)	Conn		
1	0	0	0	W2E1	0	88.2557	0		2.72211	8
2	0	0	0	W3E1	-33.774	81.5376	0		2.72211	8
3	0	0	0	W4E1	-62.4062	62.4062	0		2.72211	8
4	0	0	0	W5E1	-81.5376	33.774	0		2.72211	8
5	0	0	0	W6E1	-88.2557	-7.71556E-06	0		2.72211	8
6	0	0	0	W7E1	-81.5376	-33.774	0		2.72211	8
7	0	0	0	W8E1	-62.4062	-62.4062	0		2.72211	8
8	0	0	0	W9E1	-33.774	-81.5376	0		2.72211	8
9	0	0	0	W10E1	1.05244E-06	-88.2557	0		2.72211	8
10	0	0	0	W11E1	33.774	-81.5376	0		2.72211	8
11	0	0	0	W12E1	62.4062	-62.4062	0		2.72211	8
12	0	0	0	W13E1	81.5376	-33.774	0		2.72211	8
13	0	0	0	W14E1	88.2557	1.54311E-05	0		2.72211	8
14	0	0	0	W15E1	81.5376	33.774	0		2.72211	8
15	0	0	0	W16E1	62.4062	62.4062	0		2.72211	8
16	0	0	0	W33E1	33.774	81.5376	0		2.72211	8
17	0	0	11	W18E1	0	122.577	251.571		2.72211	23
18	0	0	11	W19E1	-46.9082	113.246	251.571		2.72211	23
19	0	0	11	W20E1	-86.675	86.675	251.571		2.72211	23
20	0	0	11	W21E1	-113.246	46.9082	251.571		2.72211	23
21	0	0	11	W22E1	-122.577	-1.0716E-05	251.571		2.72211	23
22	0	0	11	W23E1	-113.246	-46.9082	251.571		2.72211	23
23	0	0	11	W24E1	-86.675	-86.6751	251.571		2.72211	23
24	0	0	11	W25E1	-46.9082	-113.246	251.571		2.72211	23
25	0	0	11	W26E1	1.46172E-06	-122.577	251.571		2.72211	23
26	0	0	11	W27E1	46.9082	-113.246	251.571		2.72211	23
27	0	0	11	W28E1	86.6751	-86.675	251.571		2.72211	23
28	0	0	11	W29E1	113.246	-46.9082	251.571		2.72211	23
29	0	0	11	W30E1	122.577	2.14321E-05	251.571		2.72211	23
30	0	0	11	W31E1	113.246	46.9082	251.571		2.72211	23
31	0	0	11	W32E1	86.675	86.675	251.571		2.72211	23
32	0	0	11	W33E2	46.9082	113.246	251.571		2.72211	23
33	0	0	0	W1E1	0	0	11	W17E1	2.72211	1
*										

Steve Stearns, K6OIK, "All About the Discone Antenna," QEX, Jan/Feb 2007

# Discone Model

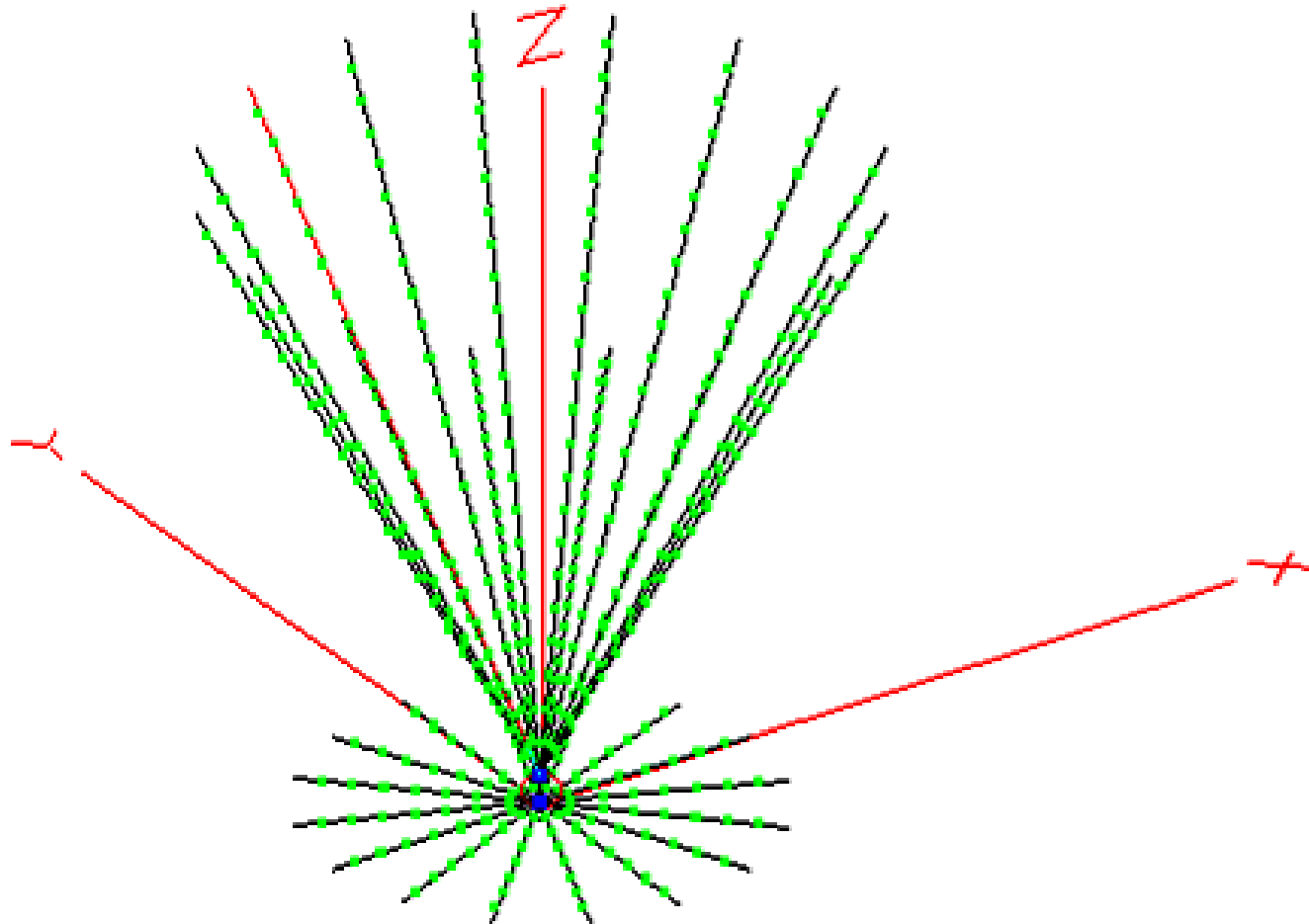

Steve Stearns, K6OIK, "All About the Discone Antenna," QEX, Jan/Feb 2007

# Discone SWR and Impedance Referenced to 75 $\Omega$

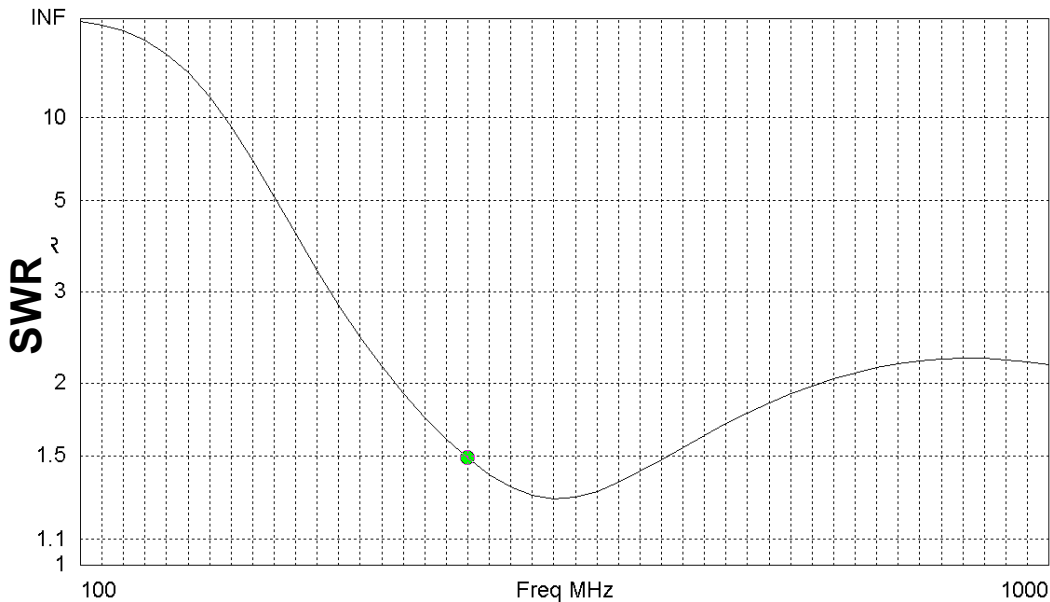

UHF TV band 470 to 710 MHz

Blue highlight

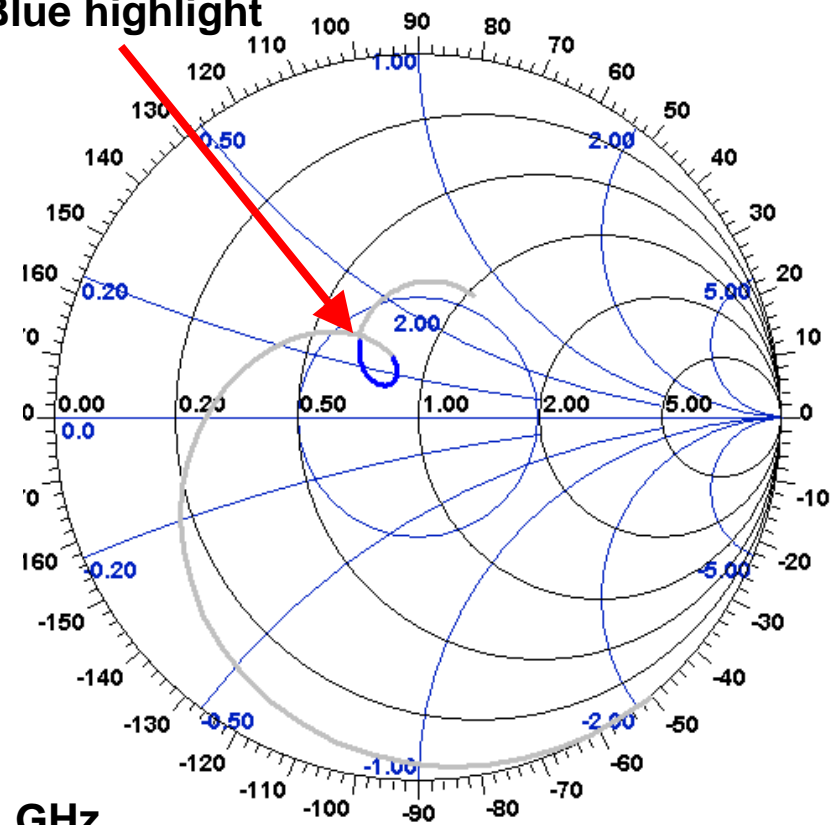

1. Perform a frequency sweep from 100 MHz to 1 GHz
2. Write impedance data to MicroSmith .gam output file
3. Reformat the .gam file to Touchstone .s1p file format
4. Import file into Smith chart or circuit simulation program
5. Design matching network

# Result After Matching

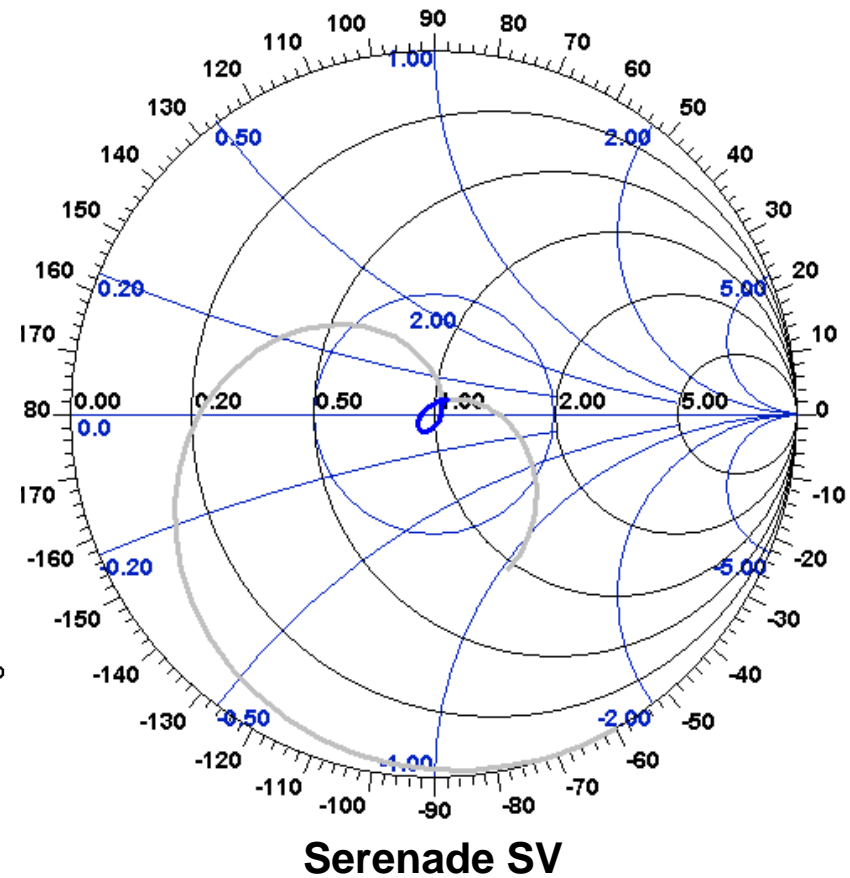
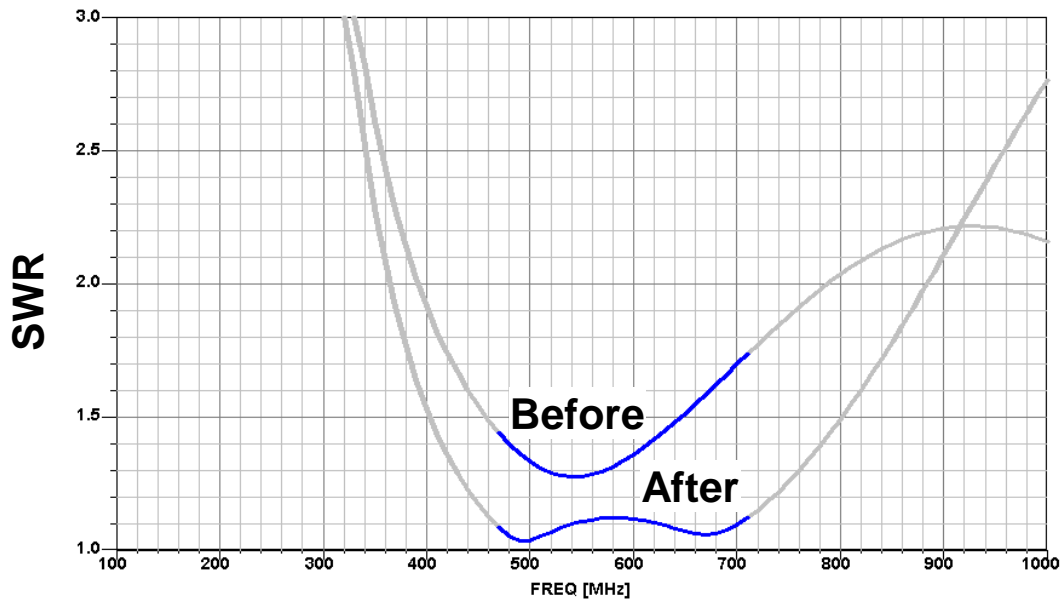

Steve Stearns, K6OIK, "All About the Discone Antenna," QEX, Jan/Feb 2007

# EZNEC Gain Patterns of Disccone at 470 MHz

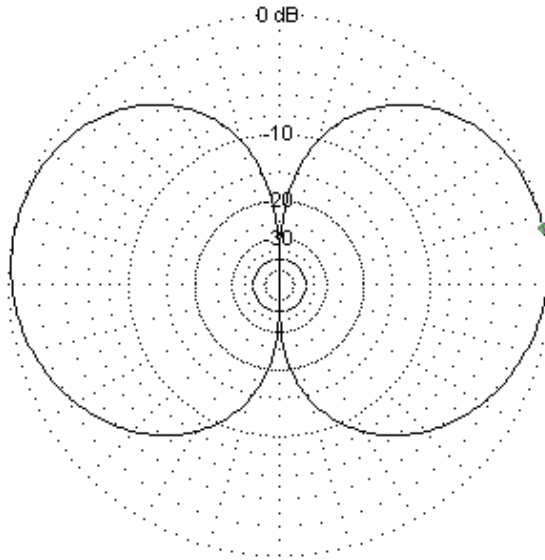

EZNEC

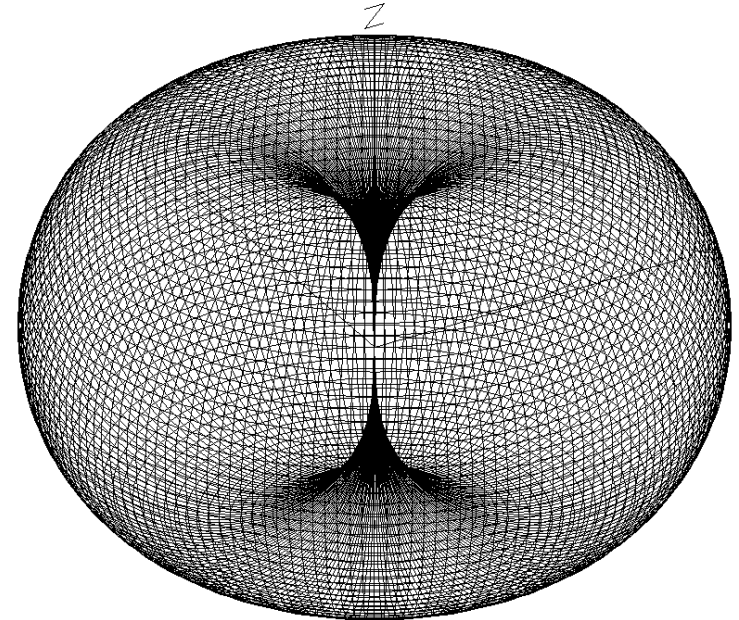

470 MHz

Elevation Plot  
Azimuth Angle 0.0 deg.  
Outer Ring 3.49 dBi

Cursor Elev 12.0 deg.  
Gain 3.49 dBi  
0.0 dBmax

Slice Max Gain 3.49 dBi @ Elev Angle = 12.0 deg.  
Front/Back 0.75 dB  
Beamwidth 87.2 deg.; -3dB @ 325.1, 52.3 deg.  
Sidelobe Gain 3.49 dBi @ Elev Angle = 168.0 deg.  
Front/Sidelobe 0.0 dB

# Tips for Getting Better Accuracy from NEC2

- **Segment length to wavelength rule**
  - Segment length  $< \lambda/20$
- **Segment length to diameter rule**
  - Segment length  $> 2 \times$  diameter is preferred
  - Segment length  $> 1.0 \times$  diameter is required (no tuna cans or hockey pucks)
- **Equal segment length rule**
  - Segments that join should have approximately equal lengths
  - Never connect long segments to short segments
- **Acute angle junction rule**
  - Junction angles or segment lengths large enough that middle 1/3 of joined segments don't interpenetrate
- **Segment alignment rule for parallel wires**
  - Closely spaced parallel wires should have their segments aligned (paired)
- **Wires near ground**
  - All wires should be least two diameters above ground
  - Wires cannot touch ground

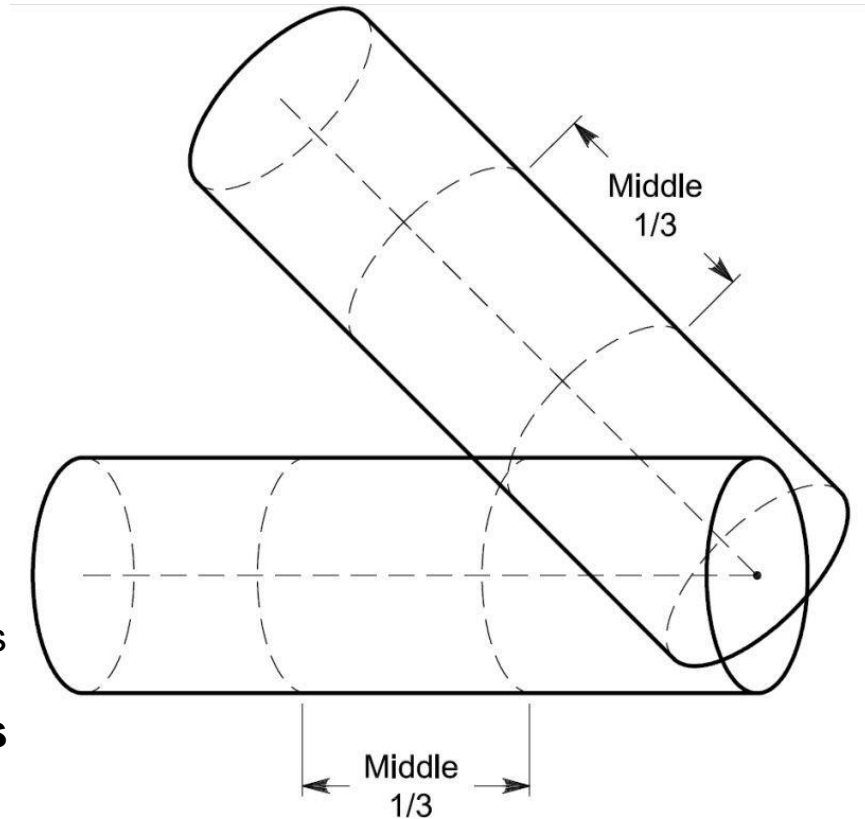

# Excitation Sources

- **NEC2 and NEC4 provide 6 excitation source types: 3 for transmit and 3 for receive or scattering analysis**
  - Multiple feedpoints are allowed and useful for phased arrays
  - Rules determining whether loads, network connections, and transmission lines are in series or parallel with source vary by source type
- **Type 0 voltage source (applied field source)**
  - Located mid segment; cannot be located in a NEC symmetry plane
  - Adjacent segments should have same length
  - A good general purpose source; not finicky
- **Type 4 current source (magnetic frill)**
  - Located mid segment; cannot be located in a NEC symmetry plane; should not be placed near ground or nearby metal
  - A good general purpose source; not finicky
- **Type 5 voltage source (bicone source)**
  - Is located at a segment end or at a junction between adjacent segments; can be located in a NEC symmetry plane
  - Junction must be of two segment that are parallel, equal lengths and radii; no 3-way junctions; no loads, network connections, or transmission lines
  - Two Type 5 sources can make a “split-feed” by putting two half-voltage sources on adjacent segment ends



# Wire Loads

- Ideal, non-radiating point loads can be inserted in any segment
- If a segment contains both source and load, they are in series
- Loads are used to model coils, traps, wire conductivity and plastic insulation
- Load types available in NEC2 are series loads of the following types
  - Constant impedance  $R + jX$
  - Series RLC network
  - Parallel RLC network
- Load types not native to NEC2
  - Loads in parallel, not series
  - Trap networks
  - Laplace impedancespositive-real rational function up to 5<sup>th</sup> degree

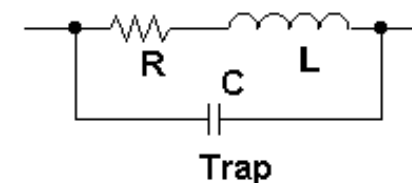
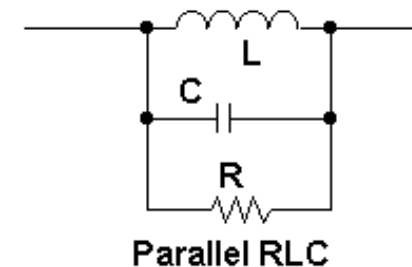
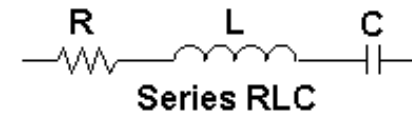

$$Z(f) = \frac{P(j\omega)}{Q(j\omega)} = \frac{a_5(j\omega)^5 + a_4(j\omega)^4 + a_3(j\omega)^3 + a_2(j\omega)^2 + a_1(j\omega) + a_0}{b_5(j\omega)^5 + b_4(j\omega)^4 + b_3(j\omega)^3 + b_2(j\omega)^2 + b_1(j\omega) + b_0}$$

# Dielectrics and Wire Insulation

- **Dielectrics occur in antennas in bulk form or insulated wires, e.g. polyrod antennas, twin-lead folded dipoles, twin-lead J-poles, Butternut radials, buried radials**
- **NEC2 has no capability for dielectrics**
- **NEC3 and NEC4 handle dielectrics by accurate methods**
  - NEC3 handles wires in semi-infinite dielectric media, e.g. buried radials
  - NEC4 handles insulated wires by accurate methods
  - Modern CEM codes such as FEKO, WiPL-D, and HOBBIES handle dielectrics accurately by surface or volume equivalence principles
- **L.B. Cebik in Note 83 attempted to reverse engineer insulated wire corrections from NEC4 but did not discover the full answer**
- **EZNEC v.4 and up claim to do insulated wires but use NEC2, which has no capability to model dielectric coated wires**
- **EZNEC Pro/4 uses NEC4, which has accurate dielectric capability**

# Insulated Wires Done Right!

## ■ Rigorous theory

- J.H. Richmond and E.H. Newman, “Dielectric Coated Wire Antennas,” *Radio Science*, Jan. 1976
- J.P.Y. Lee and K.G. Balmain, “Wire Antennas Coated with Magnetically and Electrically Lossy Material,” *Radio Science*, May-June 1979

## ■ Best approximation

- B.D. Popović and A. Nešić, “Generalisation of the Concept of Equivalent Radius of Thin Cylindrical Antennas,” *IEE Proc.*, June 1984
- Replace each insulated wire with an uninsulated wire of larger diameter
- Add distributed inductance to correct smaller inductance of larger wires

$$a' = a \times \left(\frac{b}{a}\right)^{\left(\frac{\epsilon_r - 1}{\epsilon_r}\right)} \quad \text{and} \quad L = \frac{\mu_0}{2\pi} \ln\left(\frac{a'}{a}\right) = 2 \times 10^{-7} \left(\frac{\epsilon_r - 1}{\epsilon_r}\right) \ln\left(\frac{b}{a}\right)$$

- Other methods
  - A. Yurkov RA9MB (similar method)
  - L.B. Cebik W4RNL (Note 83, less accurate)
  - D. Federov UA3AVR

# Pop Quiz

---

- **Question:**

- To model dielectric coated wire, the goal is to increase distributed capacitance  $C$  while keeping distributed inductance  $L$  constant. Sure, one can increase wire diameter to achieve desired  $C$  and then add inductive loading to achieve desired  $L$ .
- But instead, why not keep the wire diameter constant to fix  $L$  at its desired value and add capacitive loading to increase  $C$  to achieve desired value?

# Pop Quiz

---

- **Question:**

- To model dielectric coated wire, the goal is to increase distributed capacitance  $C$  while keeping distributed inductance  $L$  constant. Sure, one can increase wire diameter to achieve desired  $C$  and then add inductive loading to achieve desired  $L$ .
- But instead, why not keep the wire diameter constant to fix  $L$  at its desired value and add capacitive loading to increase  $C$  to achieve desired value?

- **Answer:**

- A wire's distributed inductance  $L$  is series inductance and distributed capacitance  $C$  is shunt capacitance
- Reactance loading is in series with the wire
- Capacitive loading inserts series not shunt  $C$ . Hence the proposed approach does not work

# Insulated Wire Equivalents

$$a' = a \times \left(\frac{b}{a}\right)^{\left(\frac{\epsilon_r - 1}{\epsilon_r}\right)} \quad \text{and} \quad L = \frac{\mu_0}{2\pi} \ln\left(\frac{a'}{a}\right) = 2 \times 10^{-7} \left(\frac{\epsilon_r - 1}{\epsilon_r}\right) \ln\left(\frac{b}{a}\right)$$

AWG wire gauge	Wire diameter $d = 2a$ (mm)	Insulation diameter $D = 2b$ (mm)	Insulation material & dielectric constant $\epsilon_r$	Equivalent diameter $d' = 2a'$ (mm)	Loading inductance $L$ (nH/m)
10 stranded	2.9	3.4	2.1 (PTFE)	3.15	16.7
10 solid	2.6	4.5	3.6 (PVC)	3.86	79.2
12 stranded	2.4	2.9	2.1 (PTFE)	2.65	19.8
12 solid	2.1	3.9	3.6 (PVC)	3.28	89.4
14 stranded	1.9	2.4	2.1 (PTFE)	2.15	24.5
14 solid	1.6	3.4	3.6 (PVC)	2.76	108.9

# Five Ground Types and Their Restrictions

- **Perfect PEC ground**
  - A lossless perfect electrically conducting (PEC) ground plane, i.e. a flat mirror
  - Wires may touch ground
  - Good for distinguishing ground loss from antenna ohmic loss
- **Real grounds**
  - High-accuracy ground (Sommerfeld-Norton)
    - Wires may not touch ground
    - Horizontal wires should be at least  $\lambda/200$  above ground
  - Fast ground (Fresnel Reflection Coefficient Analysis (RCA))
    - Wires may not touch ground
    - Horizontal wires should be at least  $\lambda/10$  above ground
  - MININEC ground
    - Uses PEC ground for calculating currents and impedance; uses Fresnel reflection coefficient for far-field pattern
    - Method of images used to calculate currents and impedance
    - Vertical and slanted wires may touch ground
    - But for accurate far field patterns, horizontal wires should be at least  $\lambda/10$  above ground (same as for Fast ground)

# Ground Parameters (Typical)

Ground Characteristics	$\sigma$	$\epsilon_r$
Extremely poor: cities, high buildings	0.001	3
Very poor: cities, industrial	0.001	4 – 5
Sandy, dry	0.002	10
Poor: rocky, mountainous	0.002	13
Average: pastoral, heavy clay	0.005	13
Pastoral: medium hills and forest	0.006	13
Flat, marshy, densely wooded	0.0075	12
Pastoral, rich soil, US midwest	0.010	14
Very good: pastoral, rich, central US	0.030	20
Fresh water	0.001 – 0.01	80 – 81
Salt water	3 – 5	80 – 81
Polar water	0.001	4
Polar ice	0.00025	3
Arctic land: frozen, permafrost	0.0005	3 – 5



# Conductivity versus Frequency

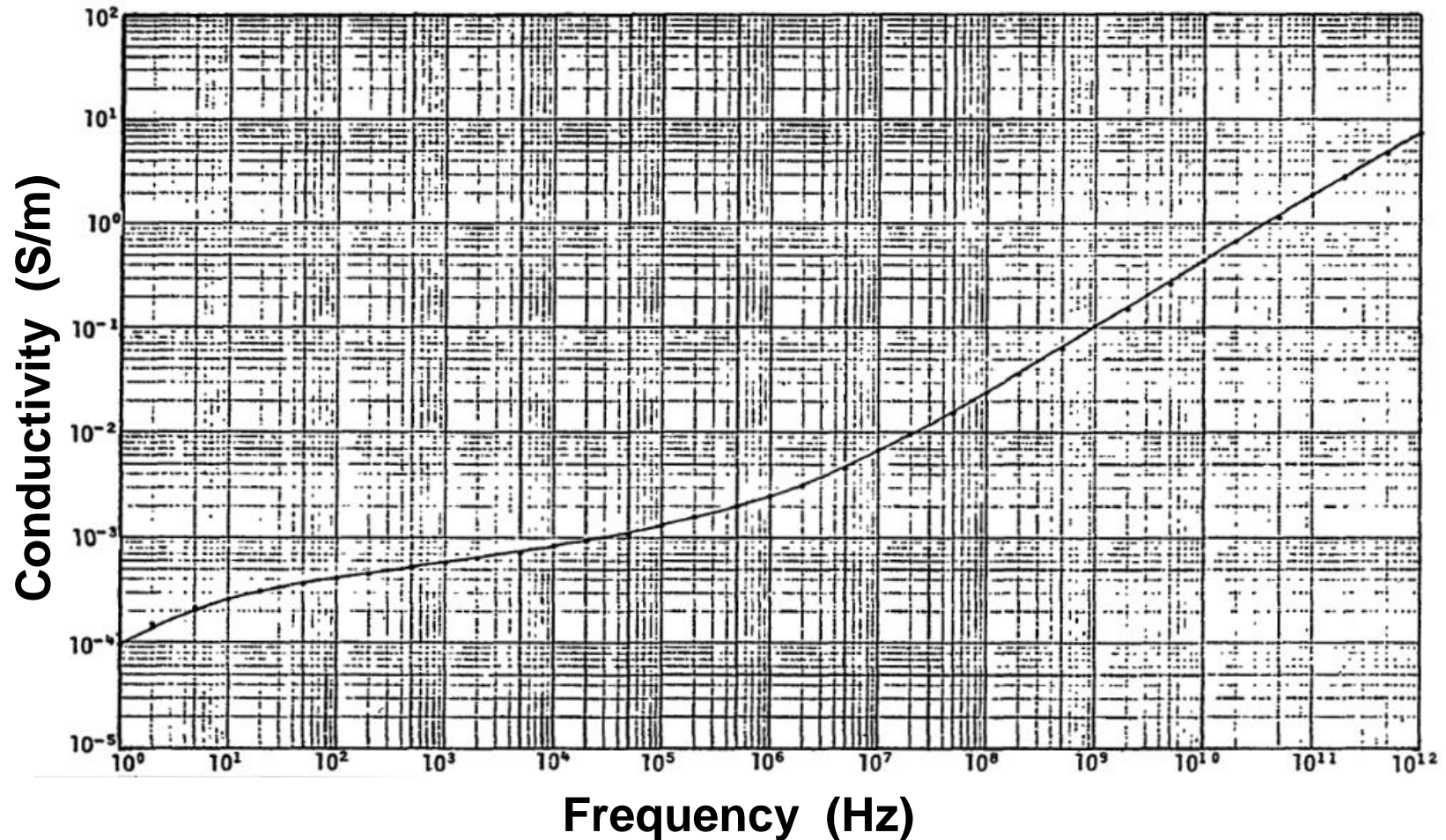

Ground conductivity  $\sigma$  and dielectric constant  $\epsilon_r$  vary with frequency and are not independent – Kramers-Kronig.

# Dielectric Constant versus Frequency

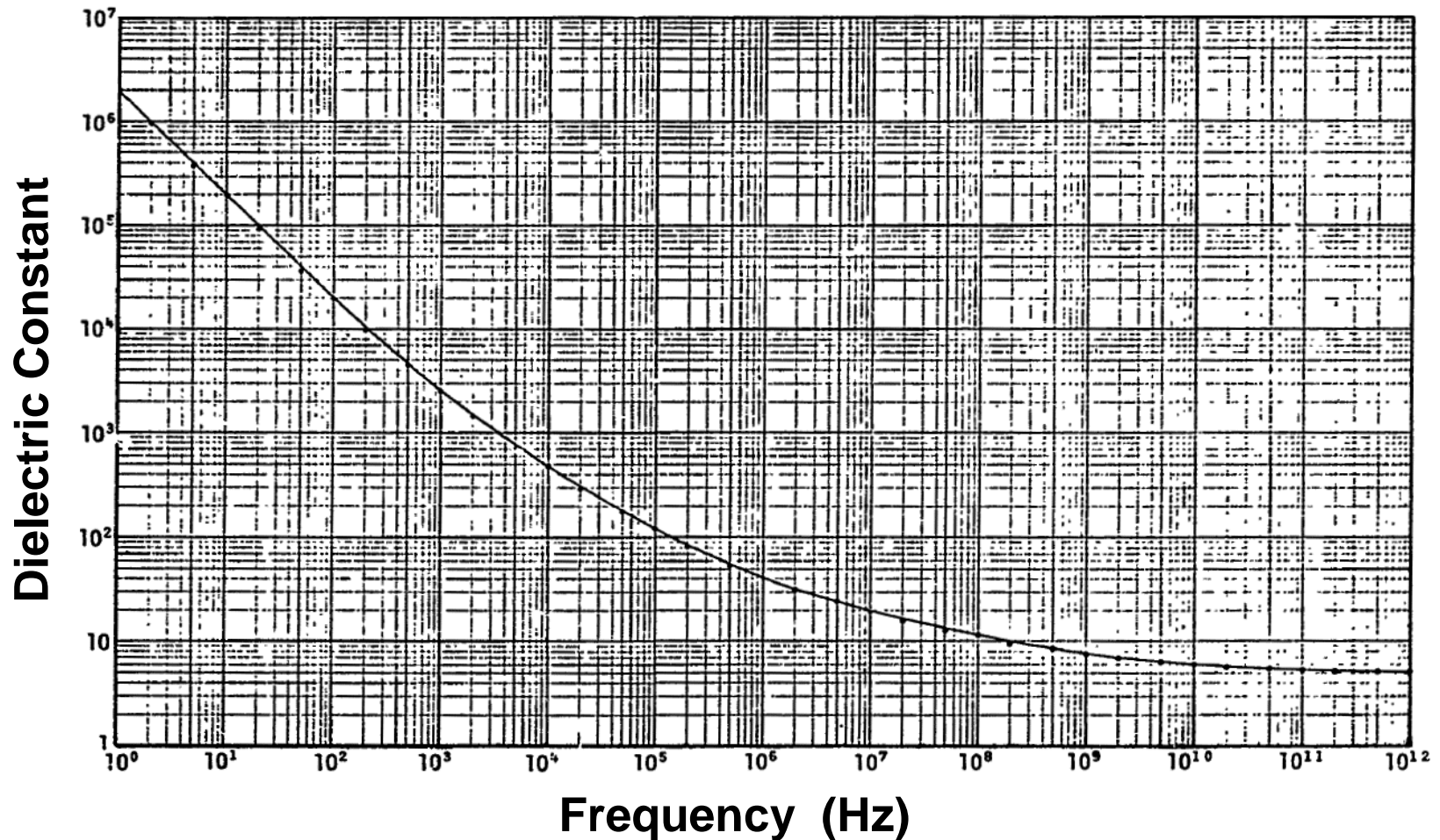

Ground conductivity  $\sigma$  and dielectric constant  $\epsilon_r$  vary with frequency and are not independent – Kramers-Kronig.

---

# 4nec2



## 4nec2 <http://www.qsl.net/4nec2>

- A **\*free\*** full-featured Windows GUI for NEC2 and NEC4
- Written and supported by Arie Voors, Netherlands
- Developed in Visual Basic for Windows XP and C++
- Includes standard EZNEC models as .nec files
- Comes with NEC2 executables, and can use NEC4 executables
- Comes configured for 11,000 segments but can be increased by recompiling the NEC2 or NEC4 source codes
- **Two versions**
  - 4nec2 – limited to machine memory
  - 4nec2X – uses virtual memory for bigger problems
- **Has 3D graphics and two optimizers**
  - Gradient descent optimizer
  - Genetic optimizer
- **Permits writing NEC script, thereby gives access to all NEC2 and NEC4 commands**

# 4nec2 Wire-Grid Models of Boeing 747 and Automobile

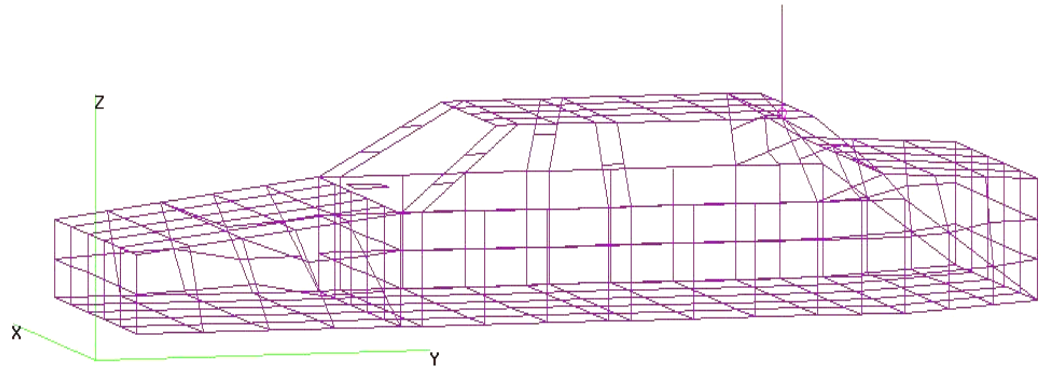
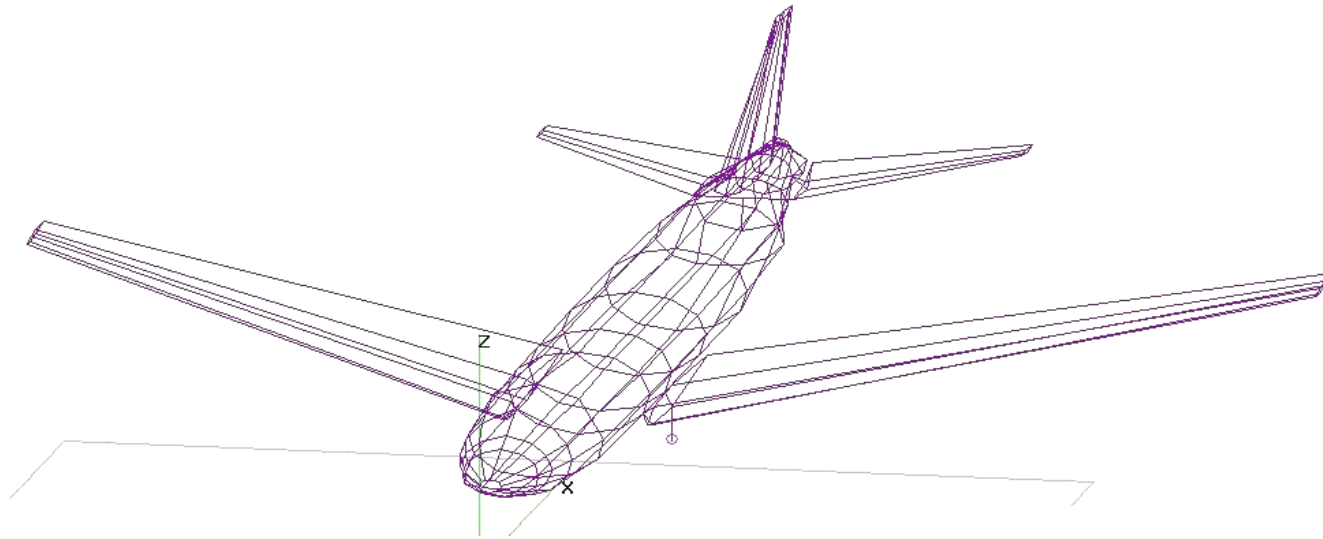

# 4nec2 Screen Displays

Main screen

Main [V5.7.2] (F2)

File Edit Settings Calculate Window Show Run Help

Filename: 747PLANE.NEC Frequency: 2 Mhz  
Wavelength: 149.9 mtr

Voltage: [ ] Current: [ ]

Impedance: [ ] Series comp.: [ ]  
Parallel form: [ ] Parallel comp.: [ ]

S.W.R. 50: [ ] Input power: [ ] W  
Efficiency: [ ] % Structure loss: [ ] W  
Radiat-eff.: [ ] % Network loss: [ ] W  
Radiat-power: [ ] W

Environment

Ground symmetry, wires for Z=0 not connected.  
Finite/Fast ground, diel-const.=13, conduct.=5 mS

Comment

"747-200 Wire frame AWG 12 2 brake points 500-150"  
Location Wire length Seg length # Seg Diam(IN) Dim (M)  
Devisors are 200 150 and 25  
Card wire # # sect x1 y1 z1 x2 y2 z2 wire size! Wires

Seg's/patches: 1603 start stop count step  
Pattern lines: [ ]  
Freq/Eval steps: 1  
Calculation time: 65.050 s

Geometry screen

Geometry (F3)

Show View Validate Currents Far-field Near-field Wire Plot

747PLANE.NEC 2 MHz

Theta : 80 Axis : 20 mtr Phi : 280

Edit screen

747PLANE.NEC - 4nec2 Edit

File Cell Rows Selection Options

Geometry (Scaling=.02)

Nr	Type	Tag	Segs	X1	Y1	Z1	X2	Y2	Z2	Radius			
1	Wire	1	5	1102.48	-128.50	118.35	1102.00	-128.50	0.00	81.0E-3			
2	Wire	2	1	100.00	20.00	226.00	100.00	15.00	239.00	81.0E-3			
3	Wire	3	1	100.00	15.00	239.00	100.00	9.00	245.00	81.0E-3			
4	Wire	4	1	100.00	9.00	245.00	100.00	0.00	246.00	81.0E-3			
5	Wire	5	1	100.00	0.00	246.00	100.00	-9.00	245.00	81.0E-3			
6	Wire	6	1	100.00	-9.00	245.00	100.00	-15.00	239.00	81.0E-3			
7	Wire	7	1	100.00	-15.00	239.00	100.00	-20.00	226.00	81.0E-3			
8	Wire	8	1	100.00	-20.00	226.00	100.00	-19.00	219.00	81.0E-3			

Wire table

# 4nec2 3D Pattern of Antenna on 747 – Vert Pol

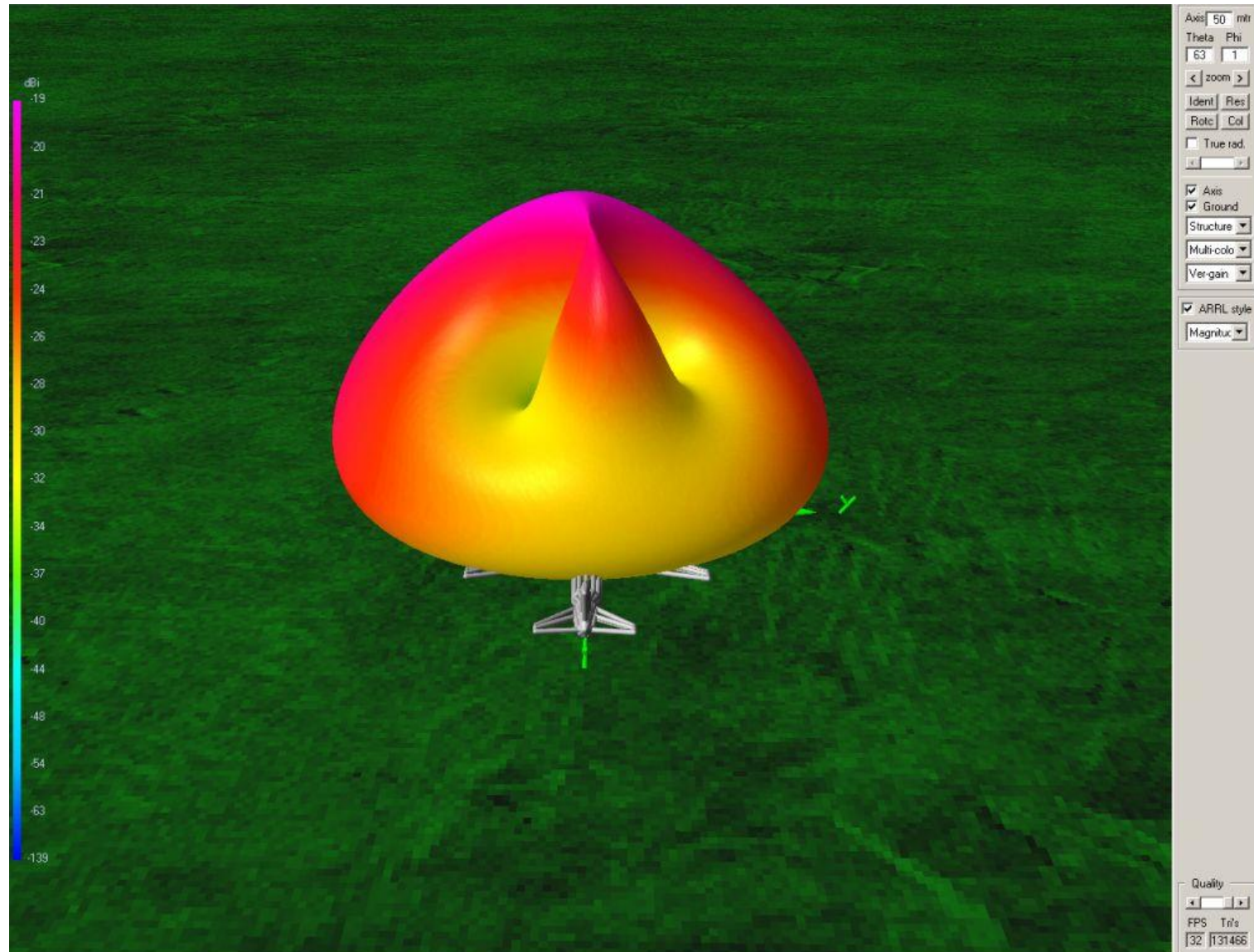

# The Equal Area Rule for Wire Grid Models of Surfaces

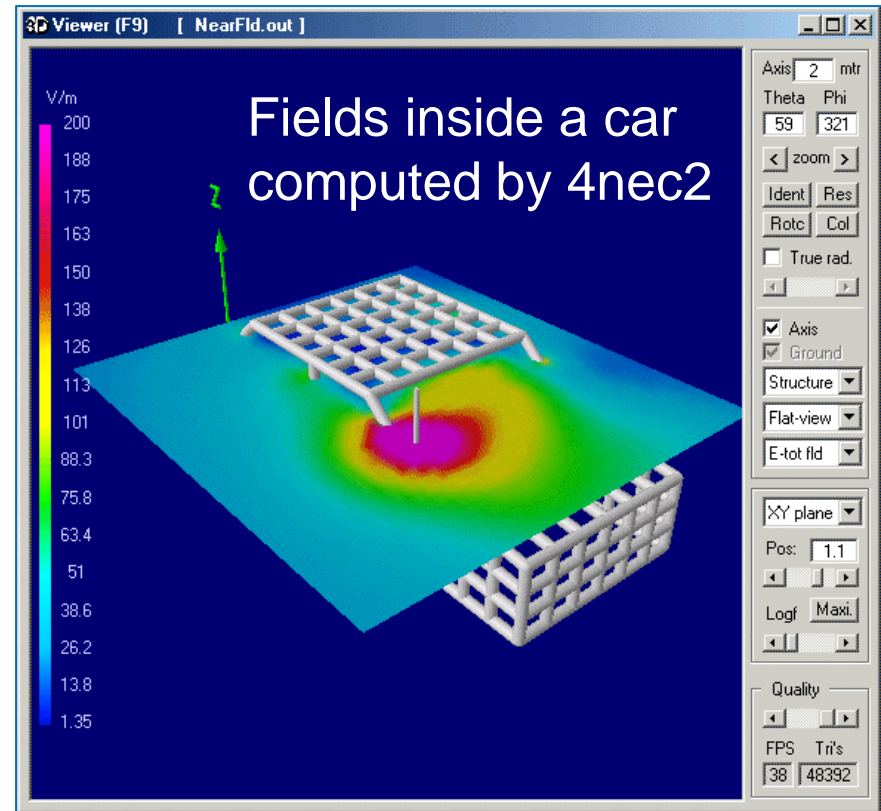
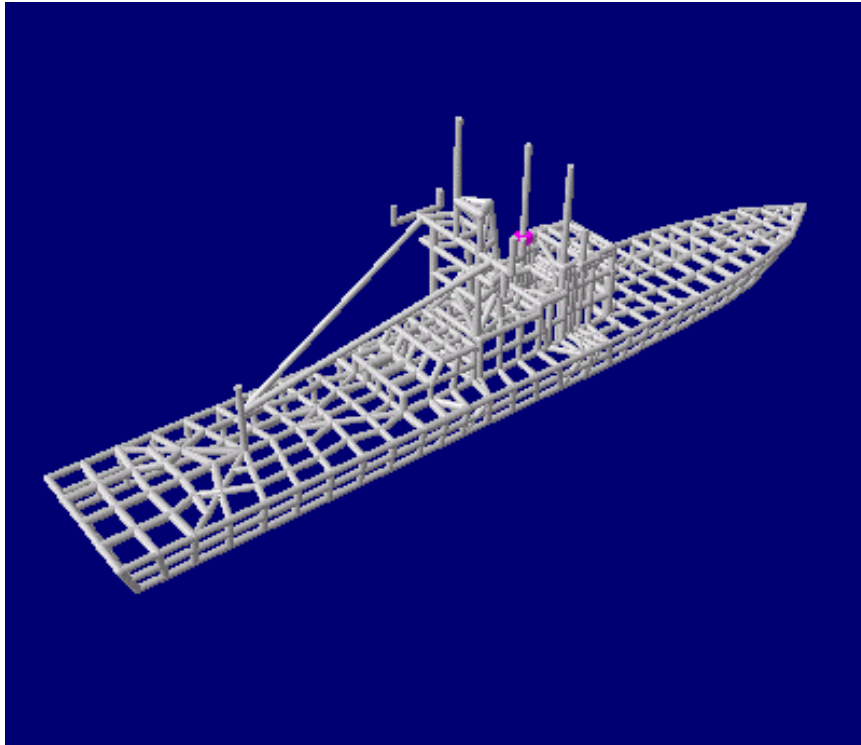

- Grid spacing determines best diameter for wires
- Wire circumference should equal center-to-center grid spacing in the direction perpendicular to wires



# Comments and Cautions on Antenna Modeling with NEC

- **NEC computes current on a wire**
  - Cannot resolve common and differential current modes
  - Cannot determine characteristic modes
- **When changing the design frequency of an antenna model, not all phenomena scale with frequency**
  - Ohmic loss increases with frequency due to skin effect
  - Insulation on wires affects common and differential current modes differently and can cause such modes to frequency scale differently
- **When modeling antennas made of insulated wire, use NEC4. With NEC2, use the method given here**
  - For circular wires with uniform circular insulation
- **Run the geometry check and average gain test to check that results (impedance, pattern, SWR) are insensitive to**
  - Small changes in source position or type
  - Small changes in segmentation density
- **Determine ground losses by comparing absolute average gain for Sommerfeld-Norton ground versus for PEC ground**
- **Always compare results against a different, independent method – measurements or a different computational technique**

---

# FEKO

## FEldberechnung für Körper mit beliebiger Oberfläche Field Calculations for Bodies with Arbitrary Surface



# FEKO <http://www.feko.info>

- **The most popular code in professional antenna engineering**
- **Developed by EM Software & Systems (EMSS), South Africa; acquired by Altair in 2014**
- **Has multiple “engines”**
  - Main method is MoM/SIE, but has MoM/VIE, FEM, FMM, and several optics approximations
- **Many features and capabilities**
  - Lossy conductors; dielectric and magnetic materials; far field, near field, and scattering calculations; optimizers including genetic algorithm; Sommerfeld-Norton ground; characteristic mode analysis; ...
- **Curved surfaces are approximated by many flat triangles**
  - Rao-Wilton-Glisson (RWG) basis functions
- **“Student Edition” is of interest to Radio Amateurs**
  - Part of HyperWorks 2017 Student Edition
  - Available at <http://www.altairuniversity.com/feko-student-edition>

# Meshed Model of Global Hawk (RQ-4A)

Coarse mesh

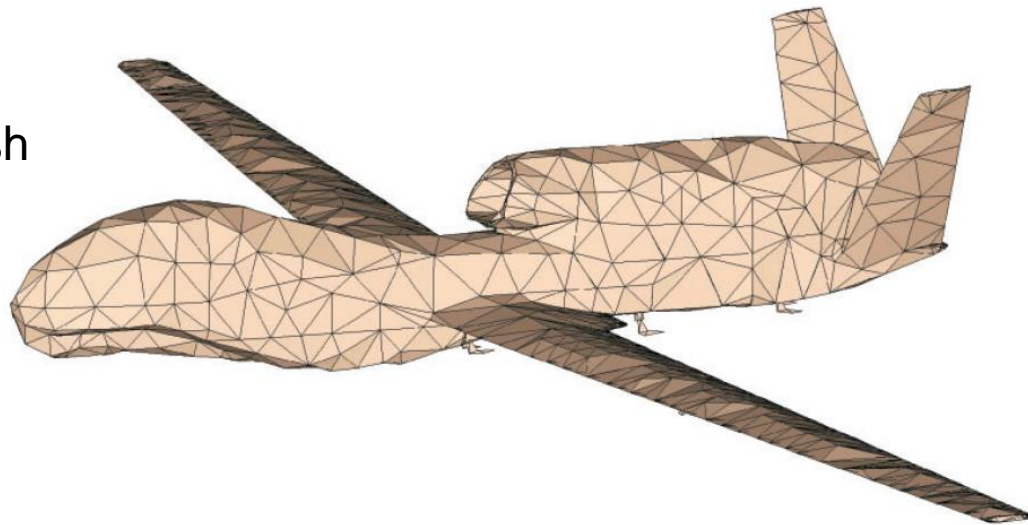

Refined mesh

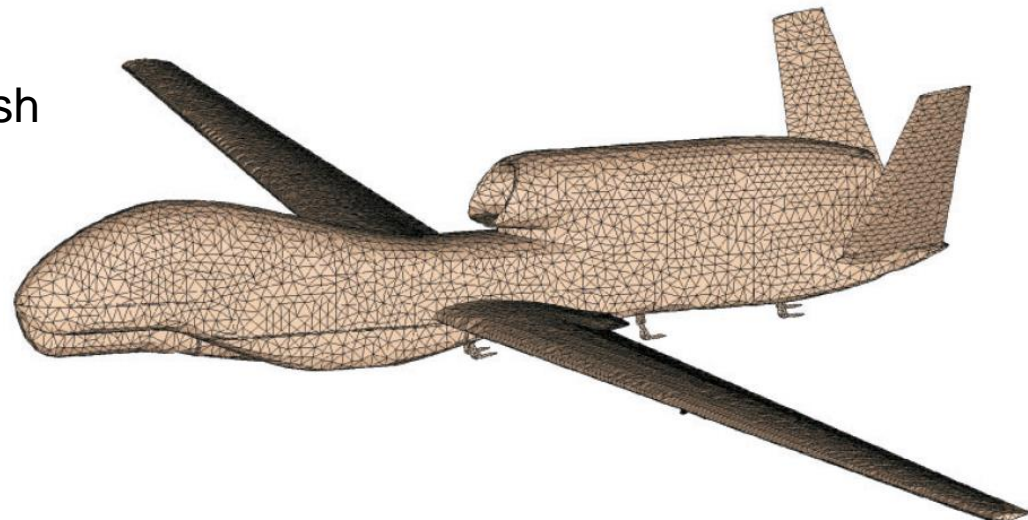

T.F. Holzer, "Electromagnetic Performance of Direction-finding Antennas Modeled on Aircraft Using Computational Electromagnetic Techniques," *Northrop Grumman Technology Review Journal*, Spring/Summer 2007

# FEKO Pattern of Horn Antenna in Wing Pod

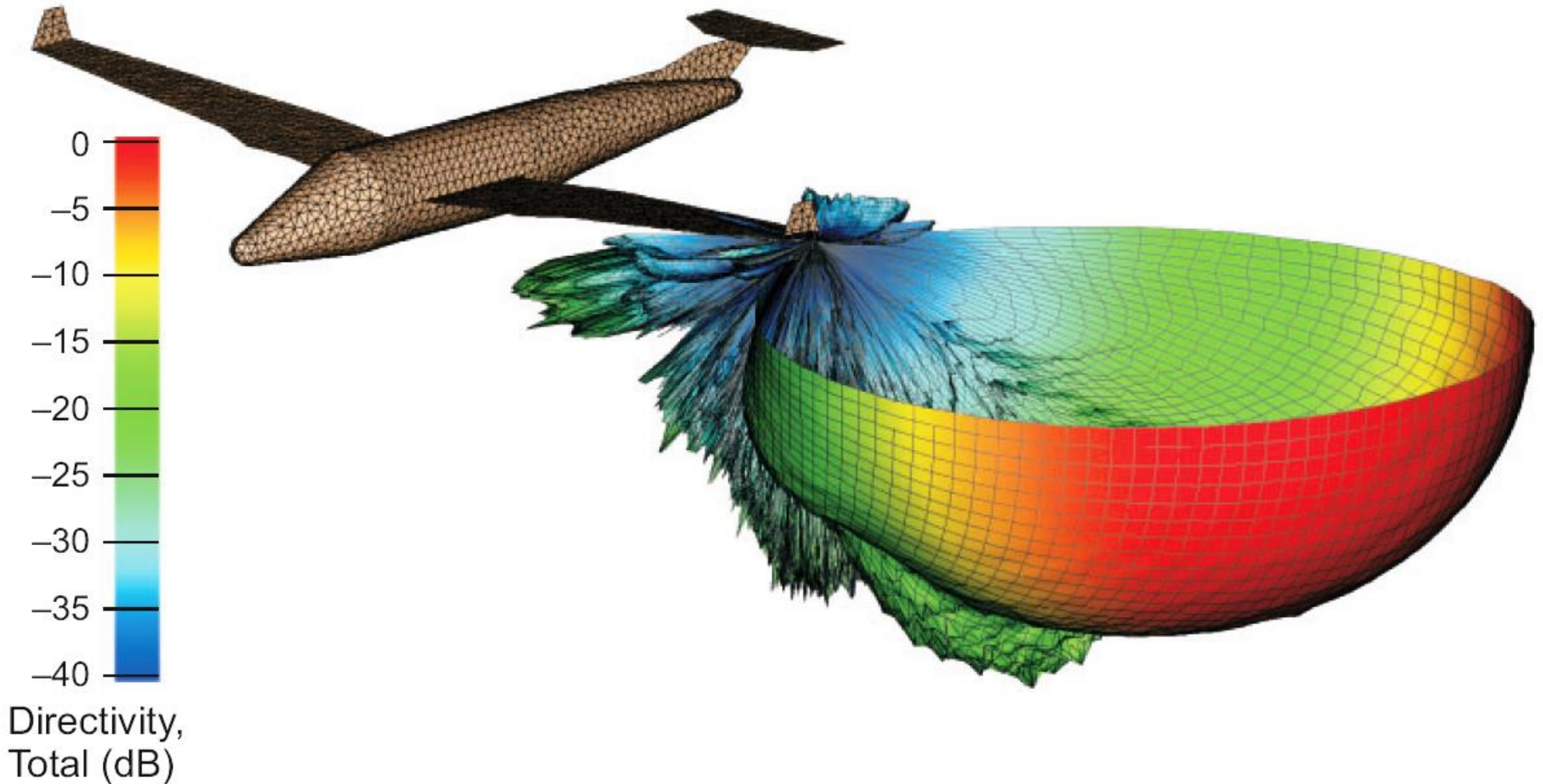

**Figure 8. Pod location, performance of horn array at 90 deg**

T.F. Holzer, "Electromagnetic Performance of Direction-finding Antennas Modeled on Aircraft Using Computational Electromagnetic Techniques," *Northrop Grumman Technology Review Journal*, Spring/Summer 2007

---

# WIPL-D

## Wires, Plates, and Dielectrics



# WiPL-D <http://www.wipl-d.com>

- Competes with FEKO in professional antenna engineering
- Originated at University of Belgrade, Serbia (former Yugoslavia)
- Now in version 14.0
- Handles 3D antennas and planar microwave circuits
- Main method is MoM/SIE, using surface equivalence principle; has fast multipole method (FMM)
- Capabilities include lossy conductors; dielectric and magnetic materials; far field, near field, and scattering calculations; optimization
- Polynomial basis functions
  - High accuracy with small computational burden
- Curved, bilinear quadrilateral surface meshing
  - Meshed surfaces appear faceted but are really bilinear curved surfaces
- Lacks Sommerfeld-Norton ground
- Versions of interest to Radio Amateurs
  - WiPL-D Pro – Free 30-day “Demo” trial includes training
  - WiPL-D Microwave Lite – Free 2006 version 6.0
  - Download from <http://www.wipl-d.com/products.php?cont=free-demo>

# WiPL-D Models of Single and 4x4 Array of Polyrods

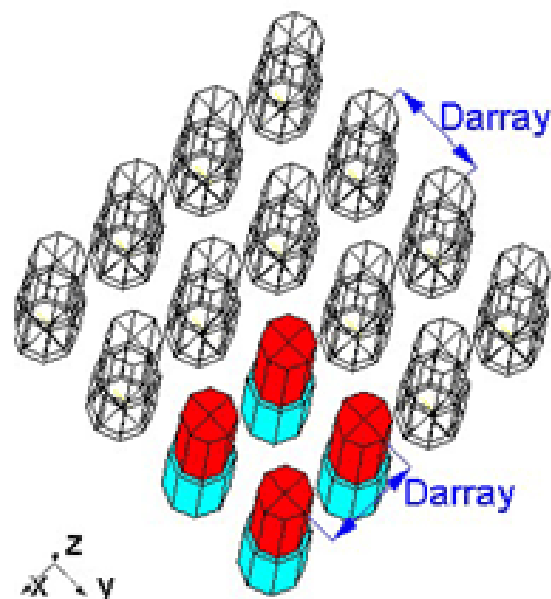
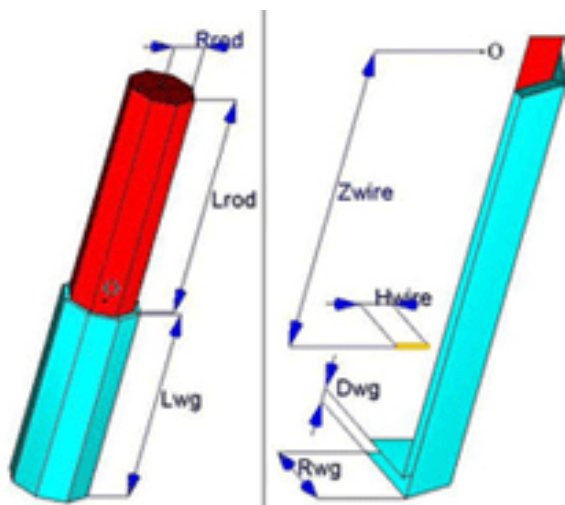

abs (E) [V/m] z=0

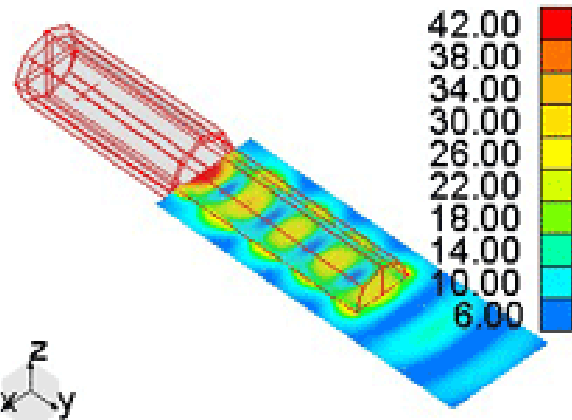

Gain [dB]

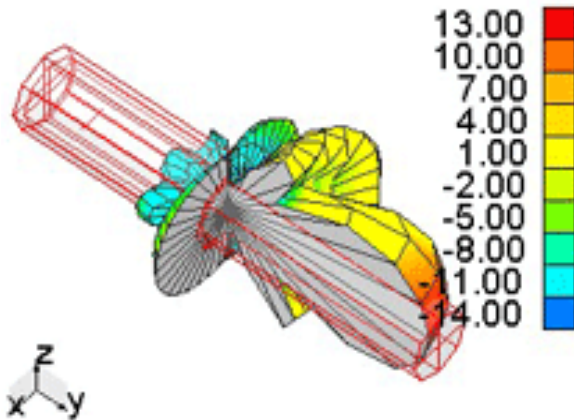

Gain [dB]

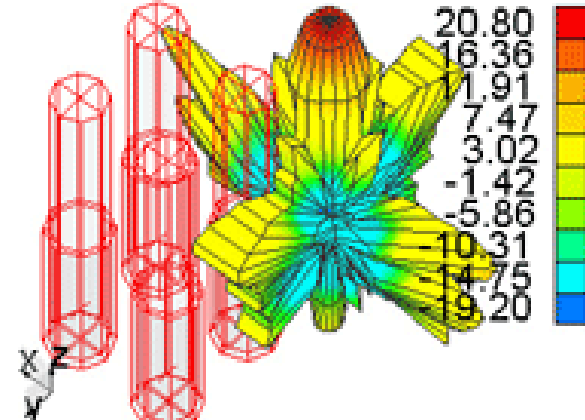



# WiPL-D Model of Fighter Plane

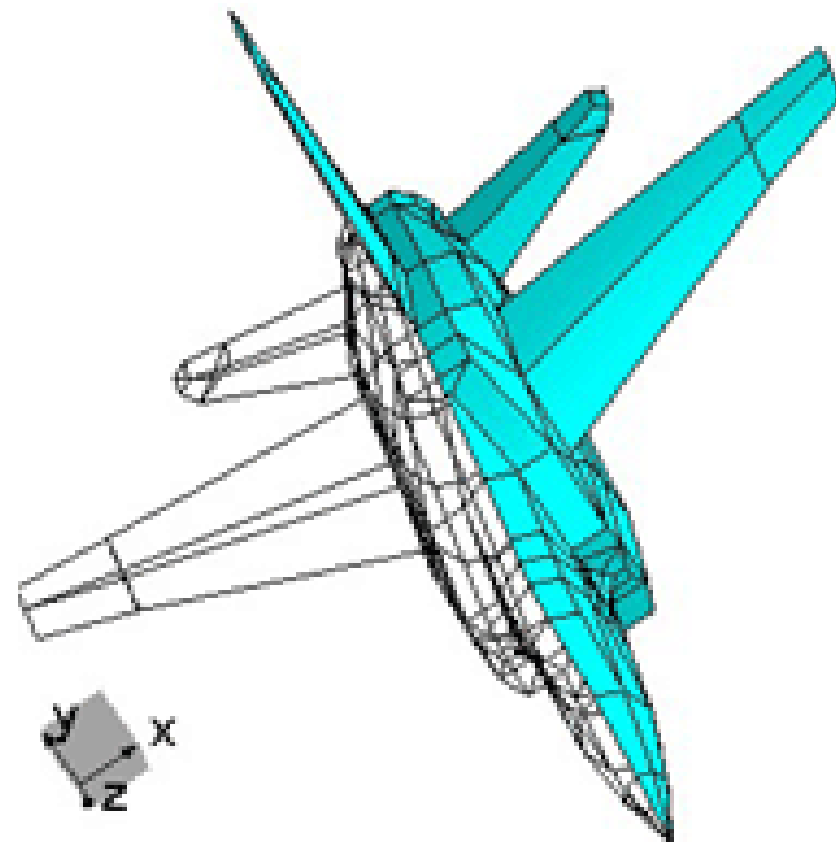
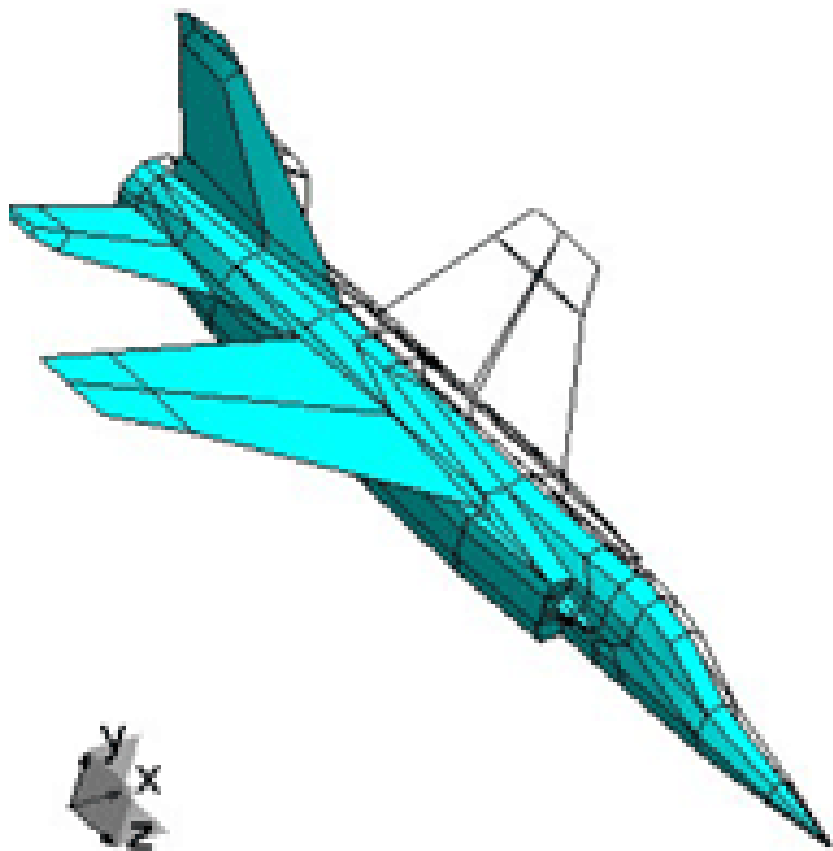

---

# HOBBIES

## Higher Order Basis Based Integral Equation Solver



# HOBBIES

- **Developed at Syracuse University funded by U.S. government**
- **Similar to WiPL-D – quadrilateral meshing, bilinear surface**
- **Current version Academic v10.5.1**
  - Download <http://www.em-hobbies.com>; need registration key to run
  - Unknowns: 15,000
  - Nodes in mesh: 3,000
  - Sample points: 5,000 (number of points in post processing display)
- **Online tutorial videos (9)**
  - Dipole antenna
  - Linear phased array of dipoles
  - Square plate scatterer
  - Cube scatterer
  - Bowtie antenna
  - Inhomogeneous dielectric cube scatterer
  - Dielectric spherical radome
  - Optimizer demo: optimizing the forward gain of a horn antenna
  - Surface meshing

# Meshed Car

---



# Near Field Scattering of 1-meter PEC Cube at 100 MHz

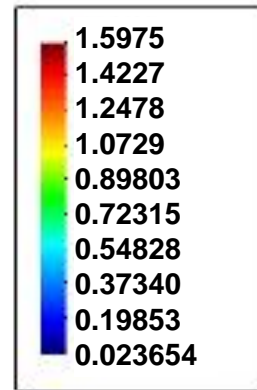
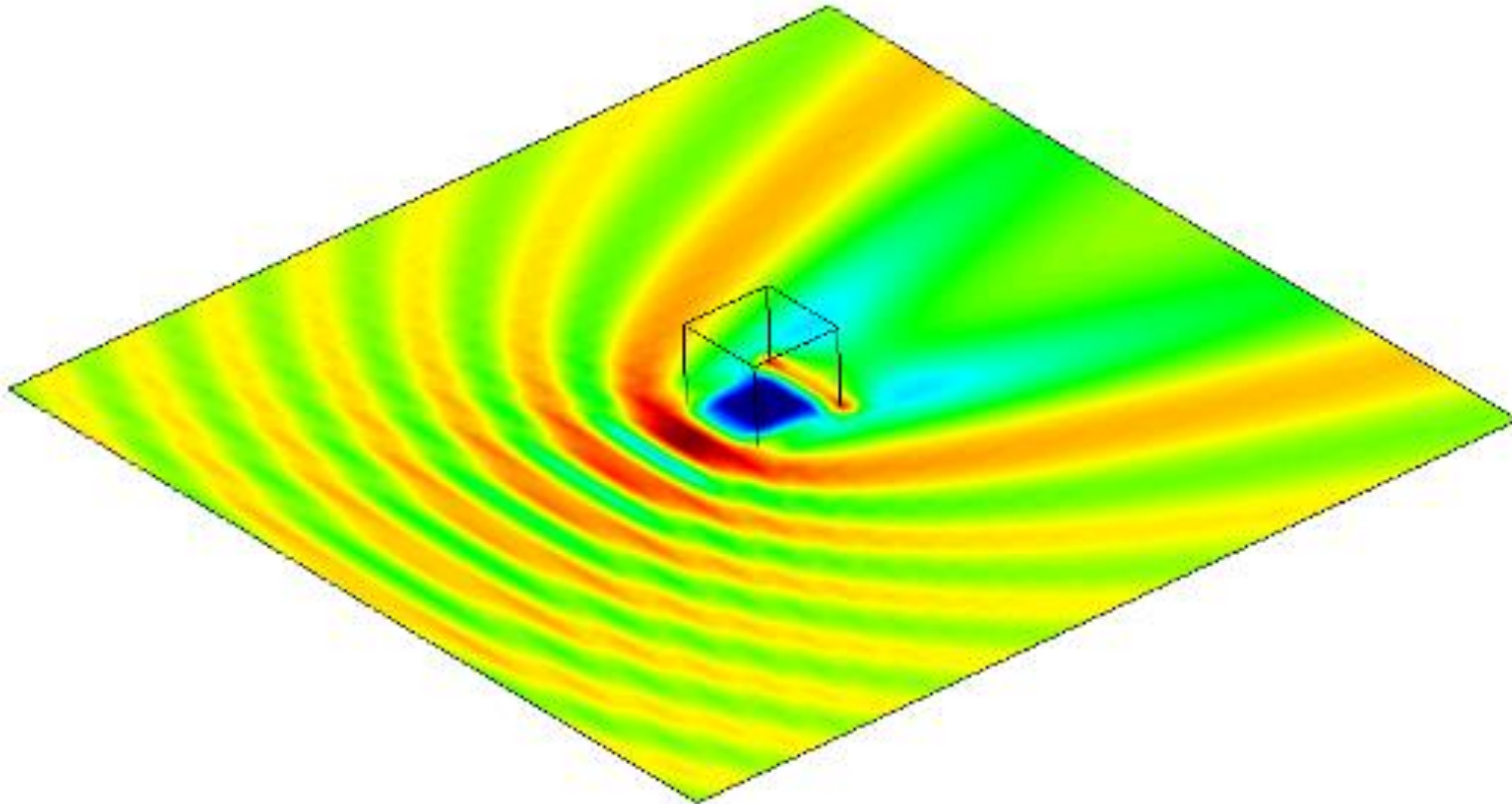

Contour Fill of  $|E|$  > Waveno. 1 100.000 MHz ( V/m ).

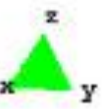

---

# **A Comparison of Programs**

## **Broadband Dipole Impedance**

# Comparison of Calculated Dipole Impedance

---

- **Antenna**
  - 1-meter dipole, diameter 20 mm,  $L/d = 50$ , segments = 51
- **Frequency range**
  - 1 MHz to 1,500 MHz
- **Methods compared**
  - Induced EMF Method (sine and cosine integrals)
  - NEC2
  - NEC4
  - FEKO
  - WiPL-D
  - HOBBIES
- **Excitation**
  - Delta-gap source

# Resistance

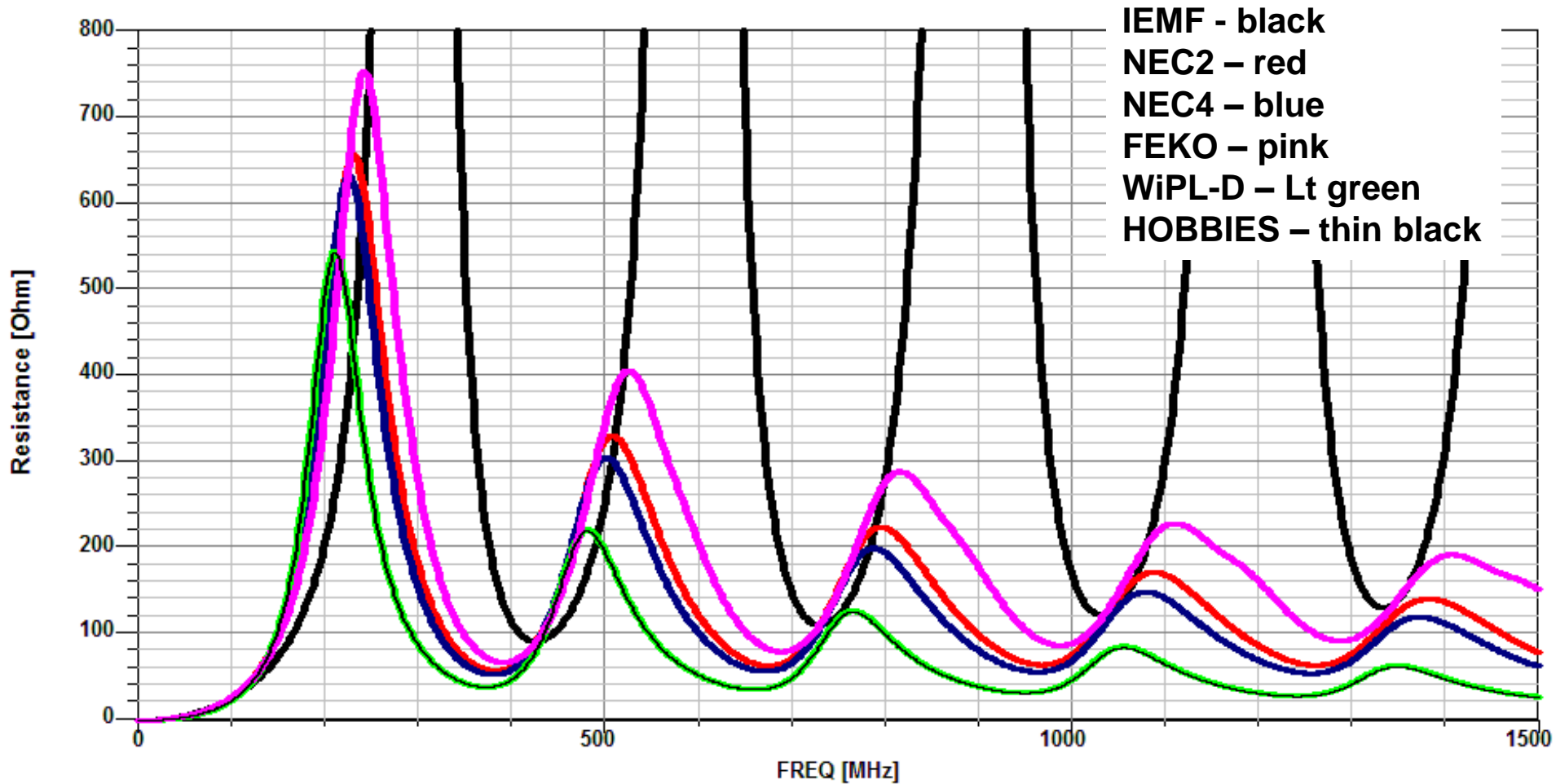

Resistances computed by different programs do not agree.



# Reactance

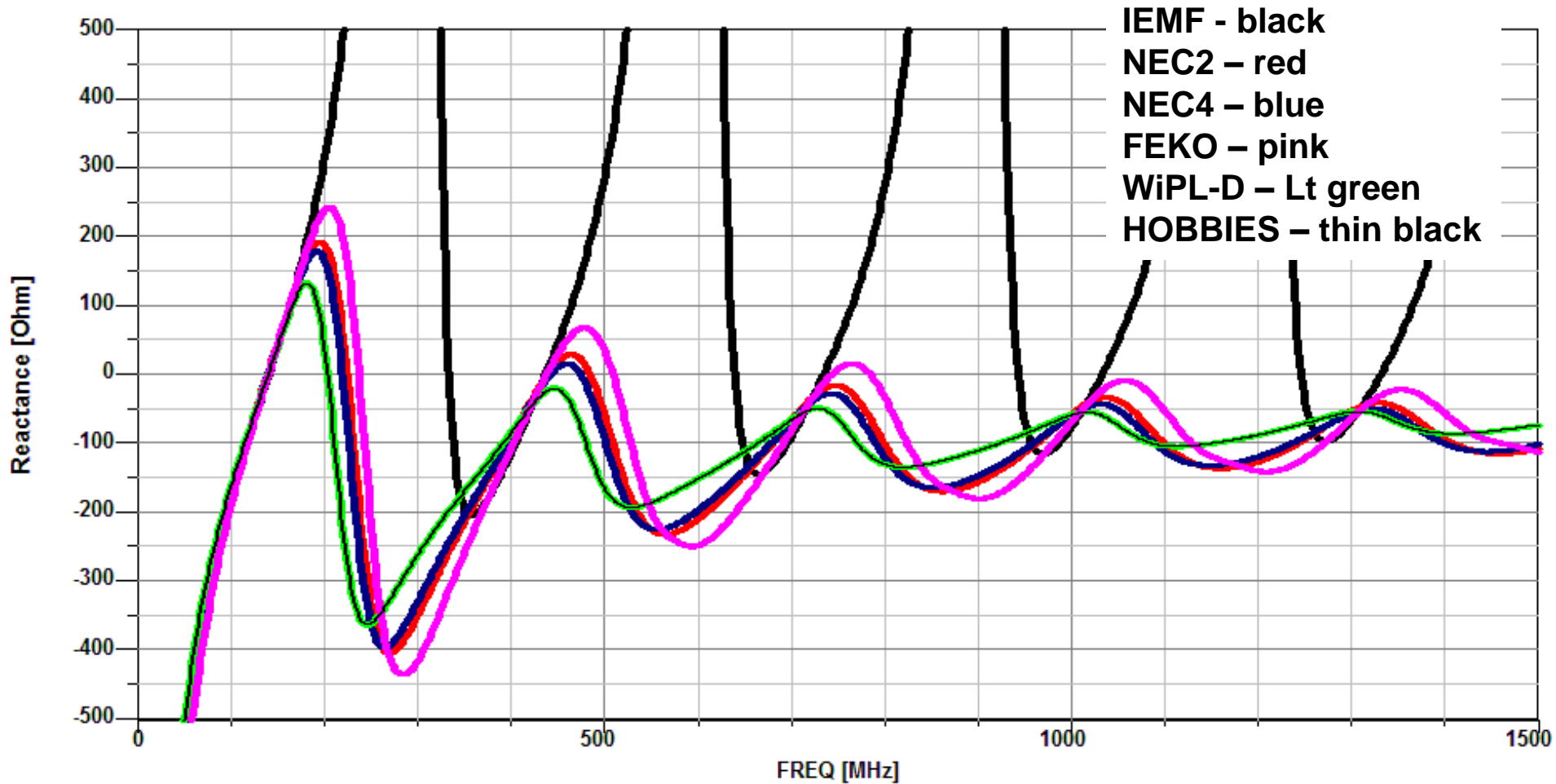

Reactances computed by different programs do not agree.

# Smith Chart – Yikes!

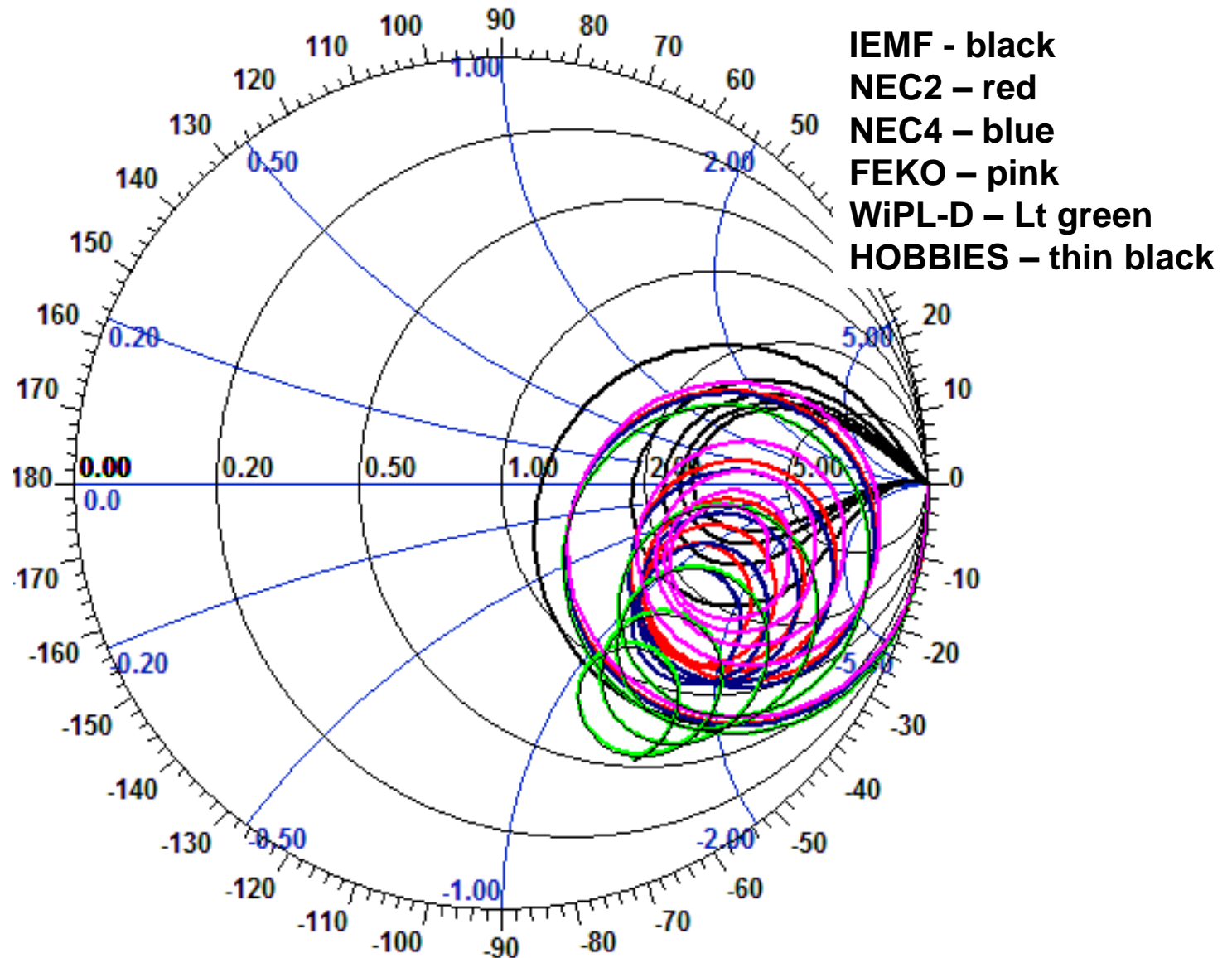

# Conductance

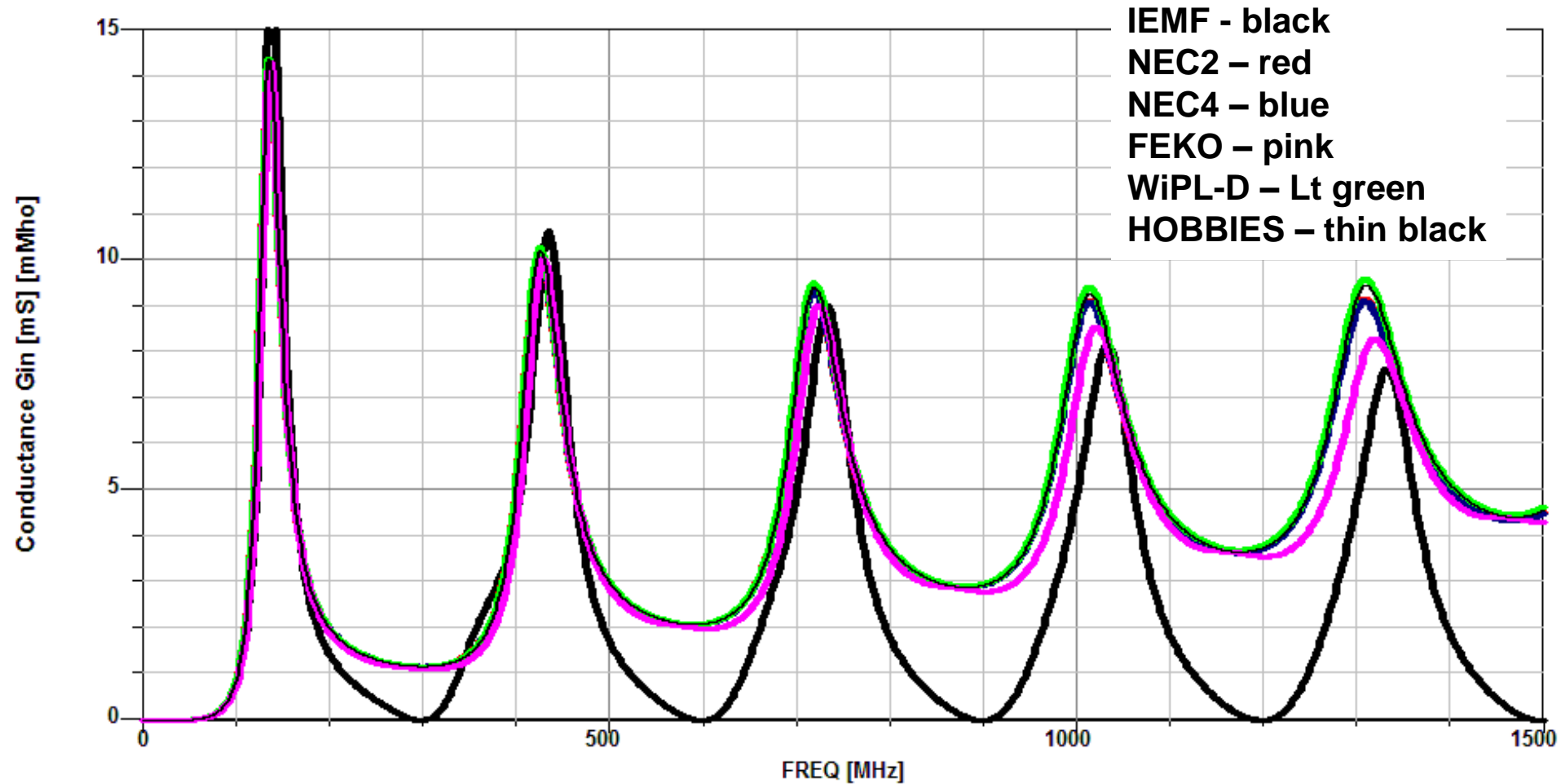

Conductances computed by different programs agree.

# Susceptance

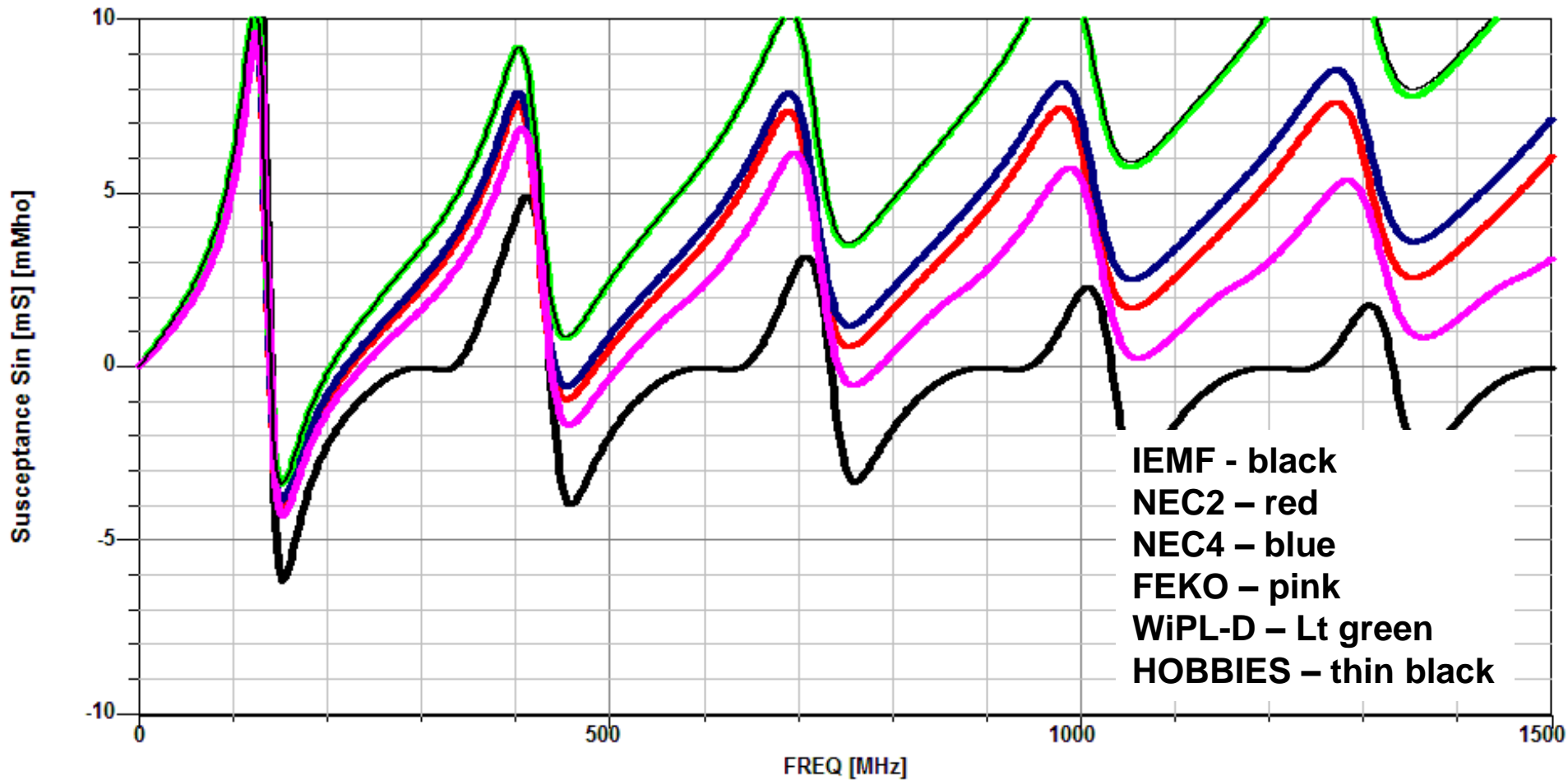

Susceptances computed by different programs differ in linear tilt.

# Explanation

---

- **HOBBIES and WiPL-D curves are identical in resistance, reactance, conductance, and susceptance**
- **Conclude that HOBBIES and WiPL-D have identical thin-wire algorithms**
- **NEC2 and NEC4 curves are highly similar**
- **All methods except IEMF have near identical conductance curves**
- **Hence differences among methods can be attributed to shunt susceptance alone**
- **Susceptance curves are the same except for linear tilts**
- **Conclude that different susceptances are due to different shunt capacitances of the delta-gap source models**
- **FEKO's delta-gap source has the smallest shunt capacitance**
- **HOBBIES and WiPL-D's delta-gap sources have the most shunt capacitance**
- **NEC2 and NEC4's delta-gap sources have intermediate shunt capacitance**

---

# **Advanced Applications**

**Terrain Modeling**

**Monopole on a Cube Planet**

**Field Strength inside Car for 2-meter Mobileers**

**Baking a Potato**

**And more ...**

# Terrain Modeling as Alternative to HFTA

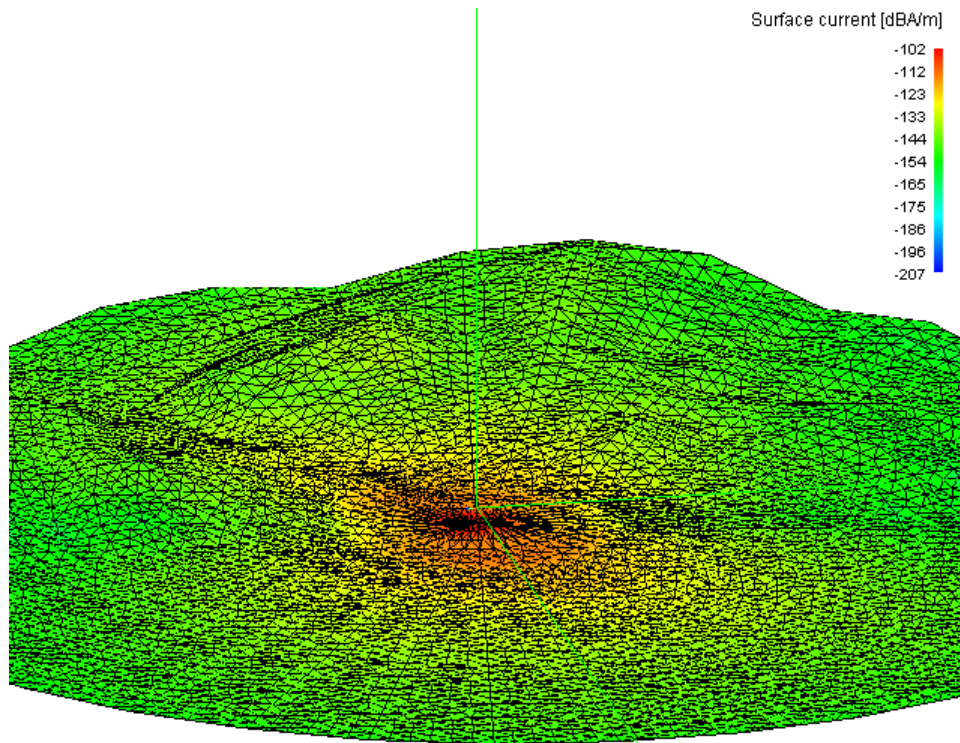

Surface meshed terrain of Saratoga, CA  
Color indicates computed earth currents  
Zoom to see current direction arrows

Earth terrain looking down  
Saratoga-Sunnyvale Road

# Ground Currents

Frequency = 7.15 MHz

Antenna type = 3 element Yagi

Antenna height = 164 ft. (50 m)

Antenna polarization = horizontal

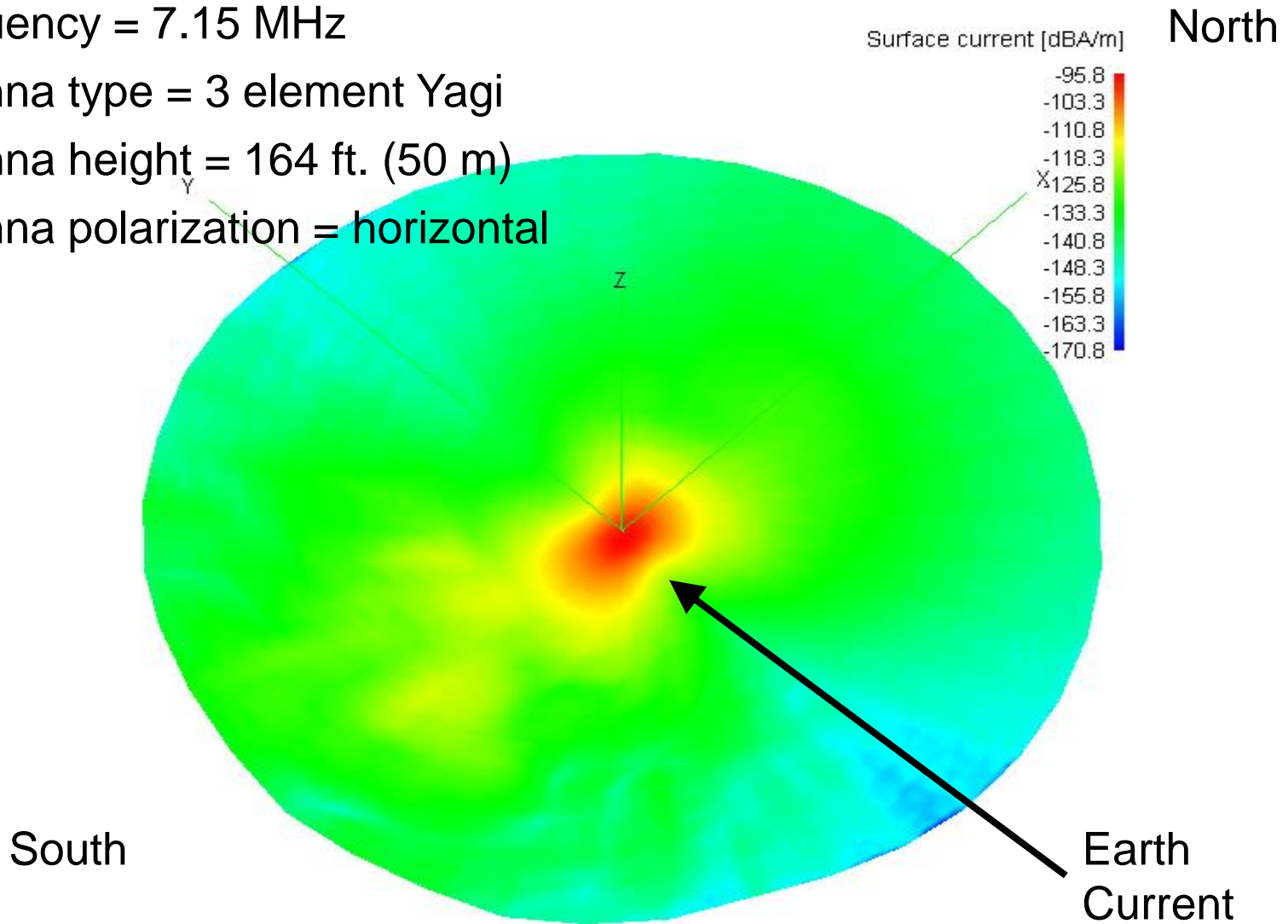



# 3D Antenna Pattern

Frequency = 7.15 MHz

Antenna type = 3 element Yagi

Antenna height = 164 ft. (50 m)

Antenna polarization = horizontal

$|E|$  field pattern shown

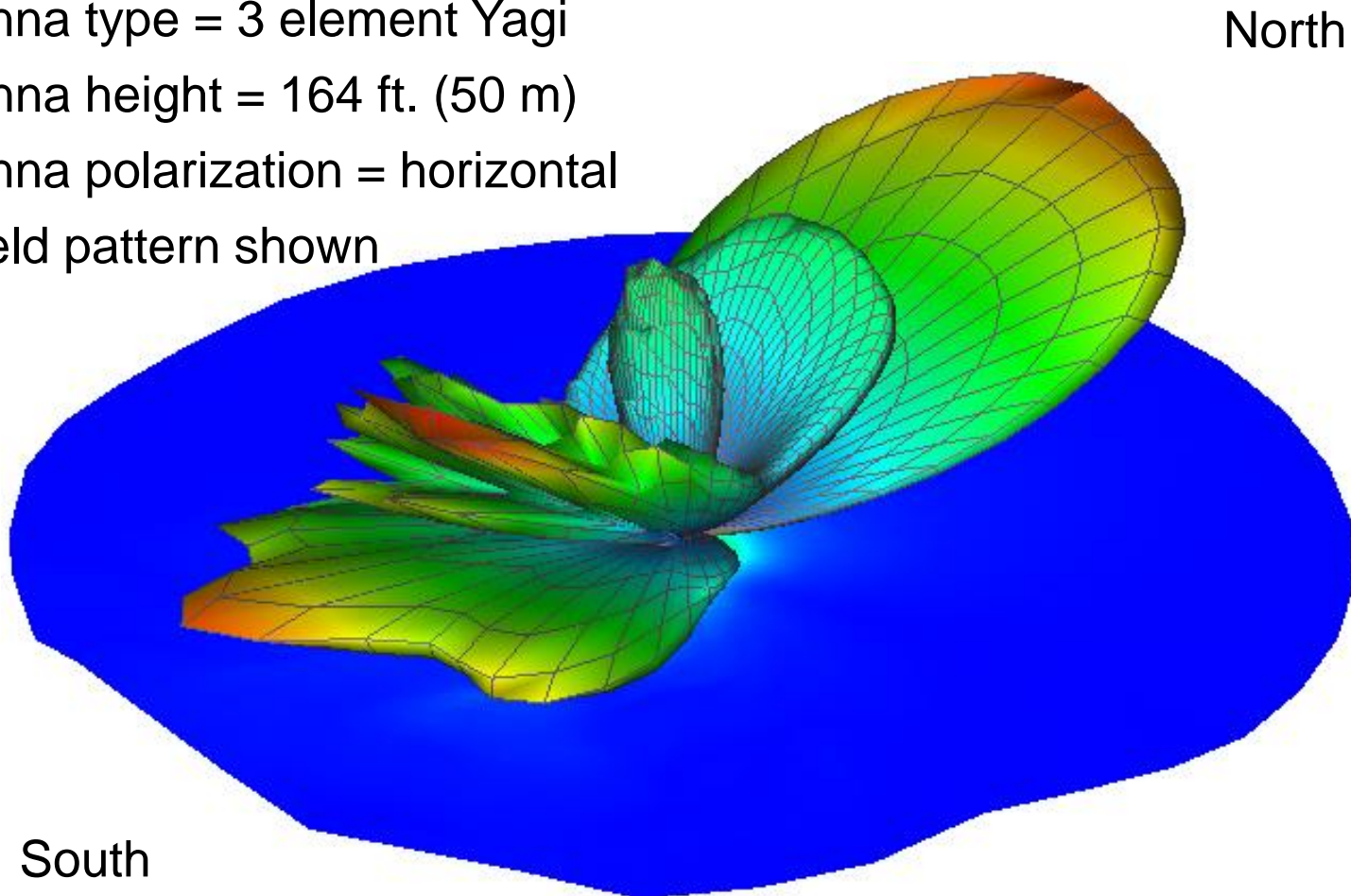

Courtesy of Keith Snyder, KI6BDR

# Computation Statistics

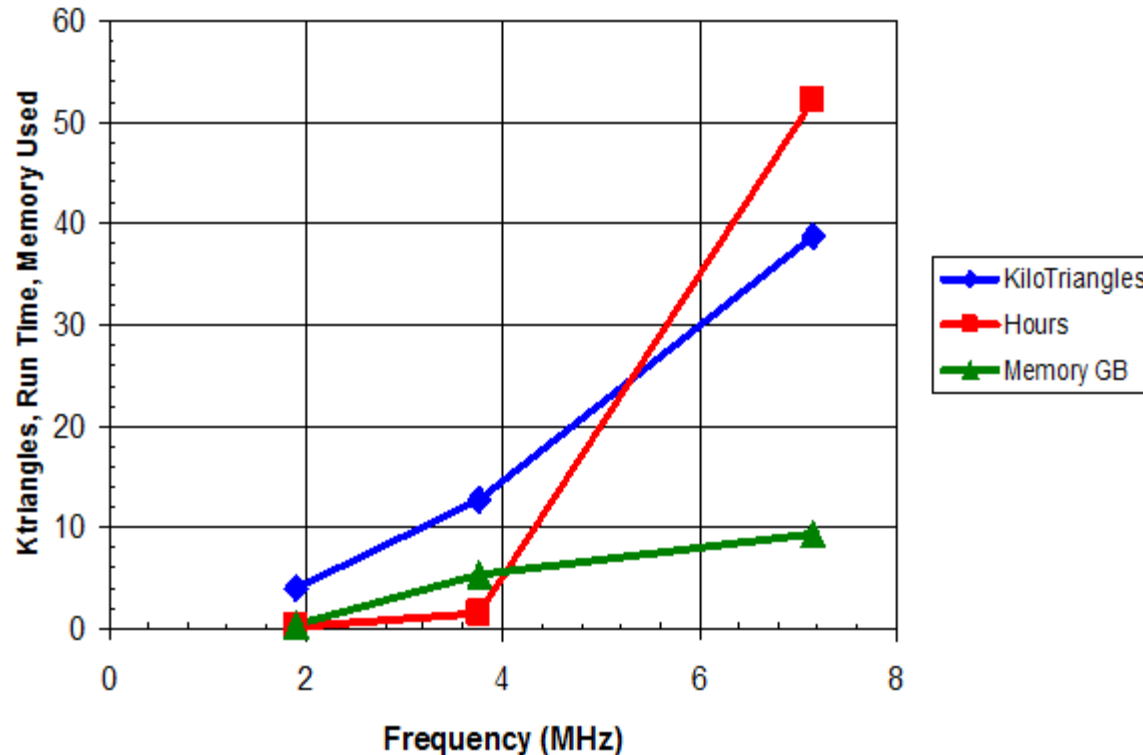

Computer	6 Xi NetRAIDER network servers
Processors	12 AMD Opteron 64-bit
Memory	96 Gbytes
Disk storage	12 Tbytes
Compute speed	> 53 GFLOPs/sec

Frequency (MHz)	Triangles	Hours	Memory (GB)
1.900	3,928	0.125	0.53
3.750	12,834	1.54	5.48
7.150	38,717	52.1	9.38

# The Next Step – Modeling the Landscape

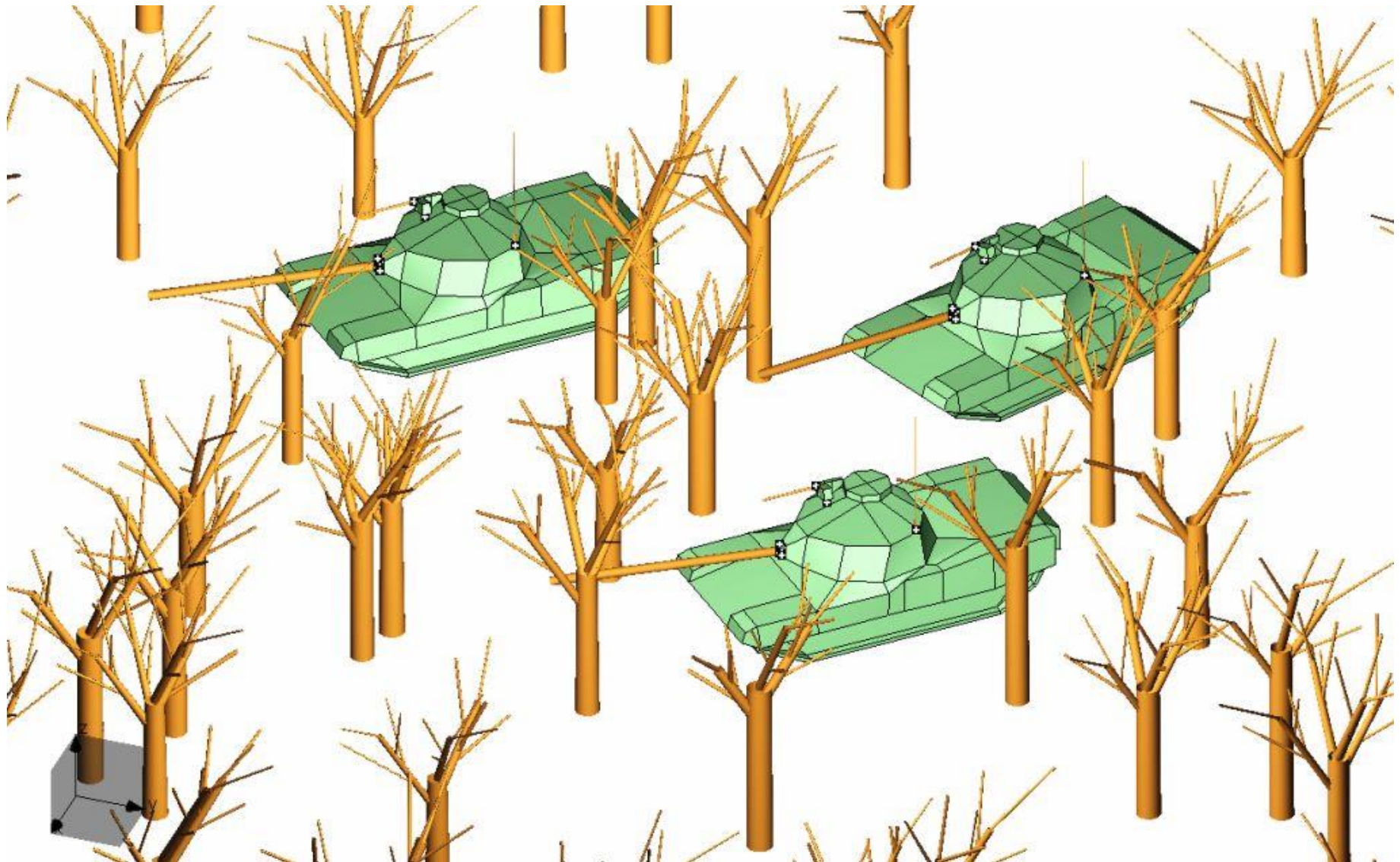

# Landscaping Details

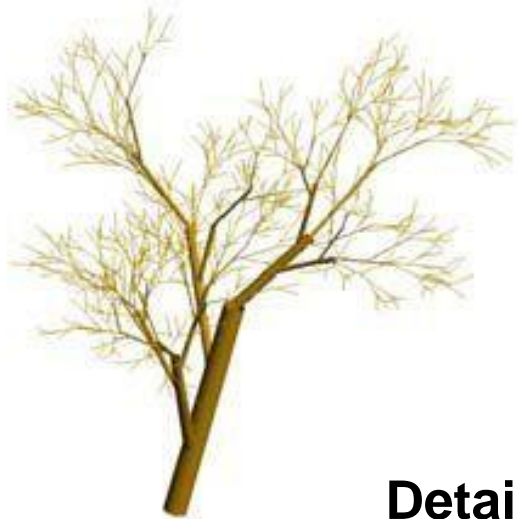

**Models of trees**



**Details of leaves and branches**



Courtesy of WiPL-D

---

# **Monopole on Planet Cubo**

## **HOBBIES**

# 0.5-m Dipole Half in 0.6-m Dielectric Cube or 0.25-m Monopole Fed Against a 0.25-m Ground Rod

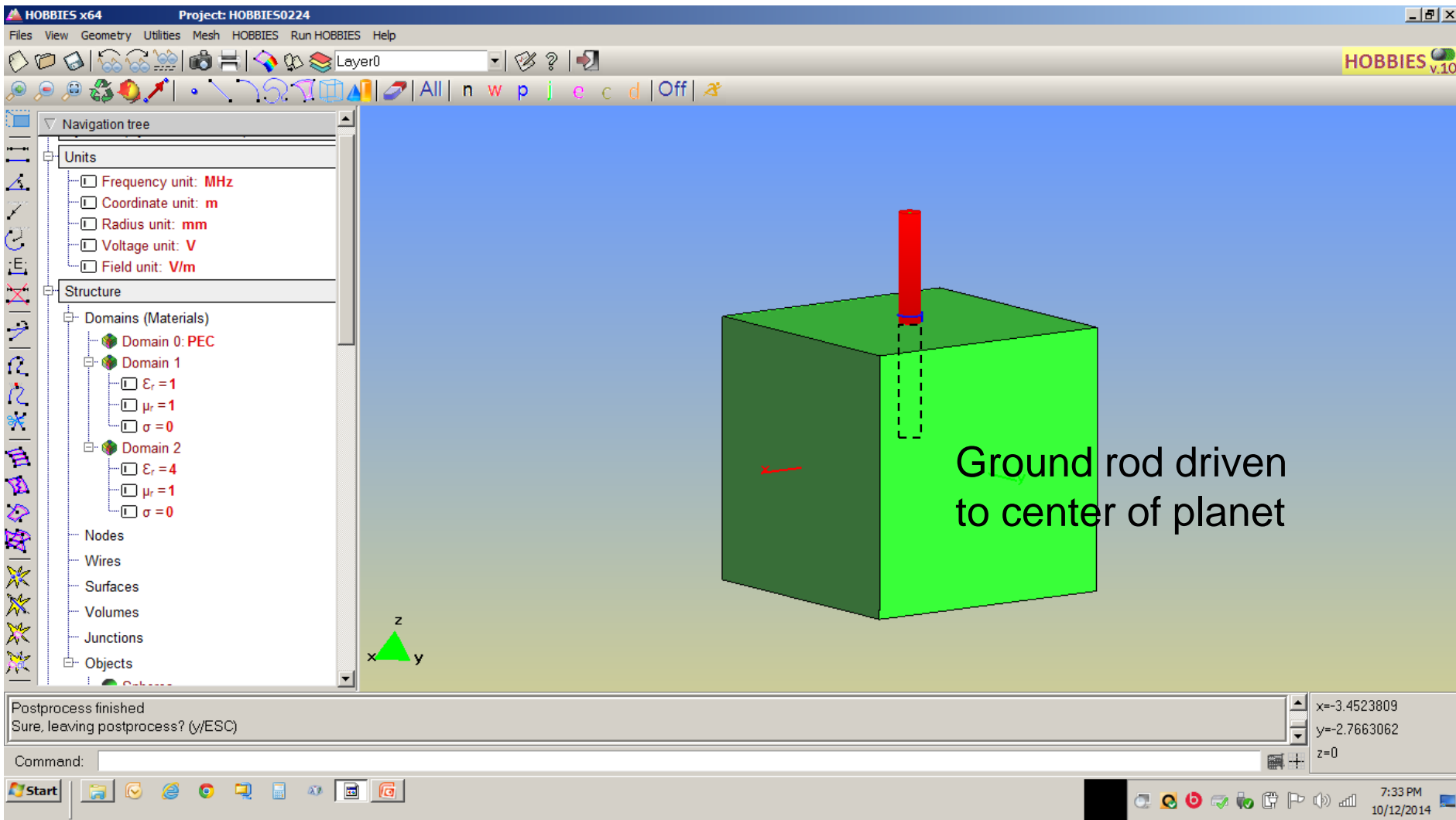

# -Return Loss

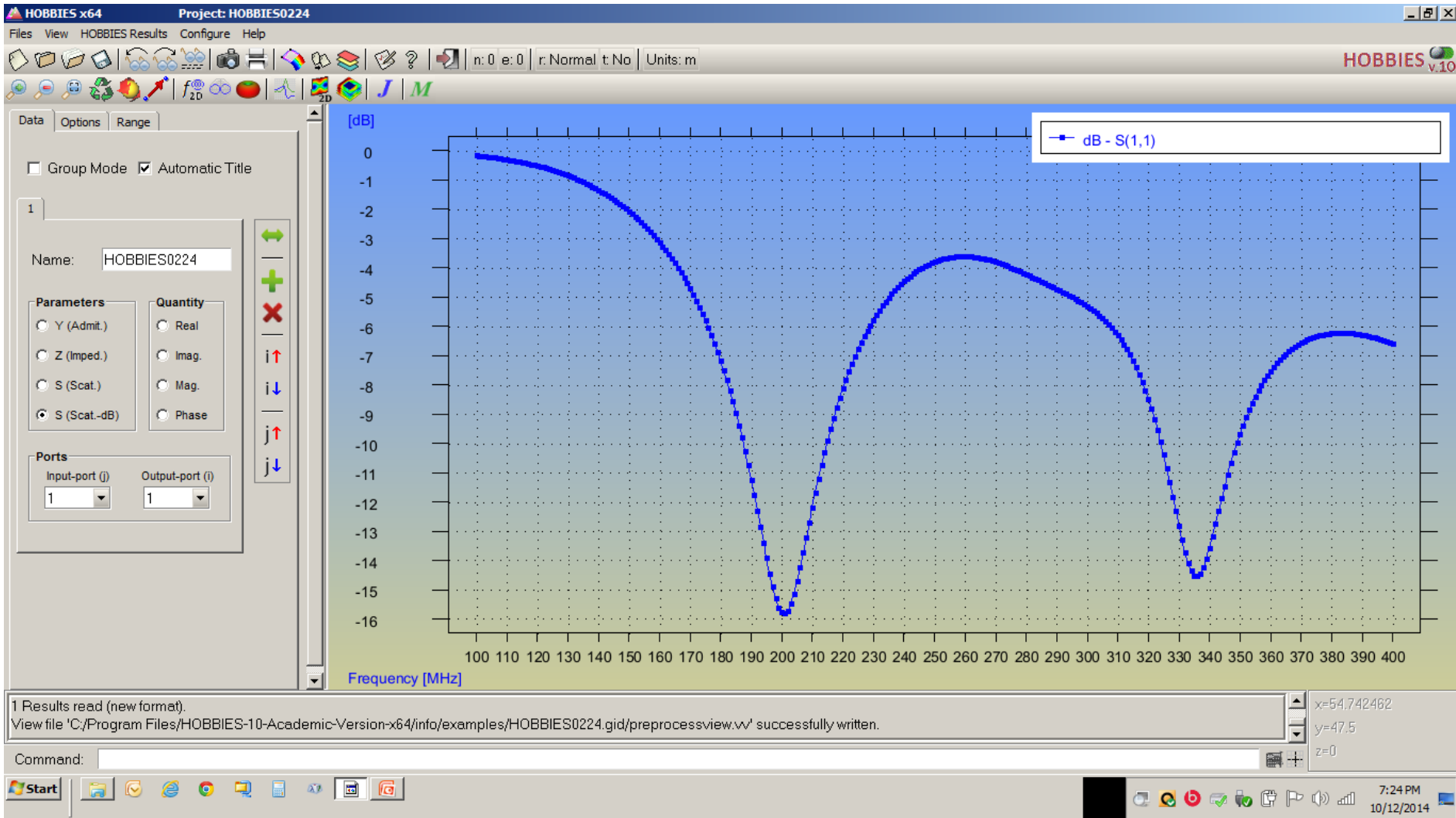

# Antenna Pattern at 200 MHz

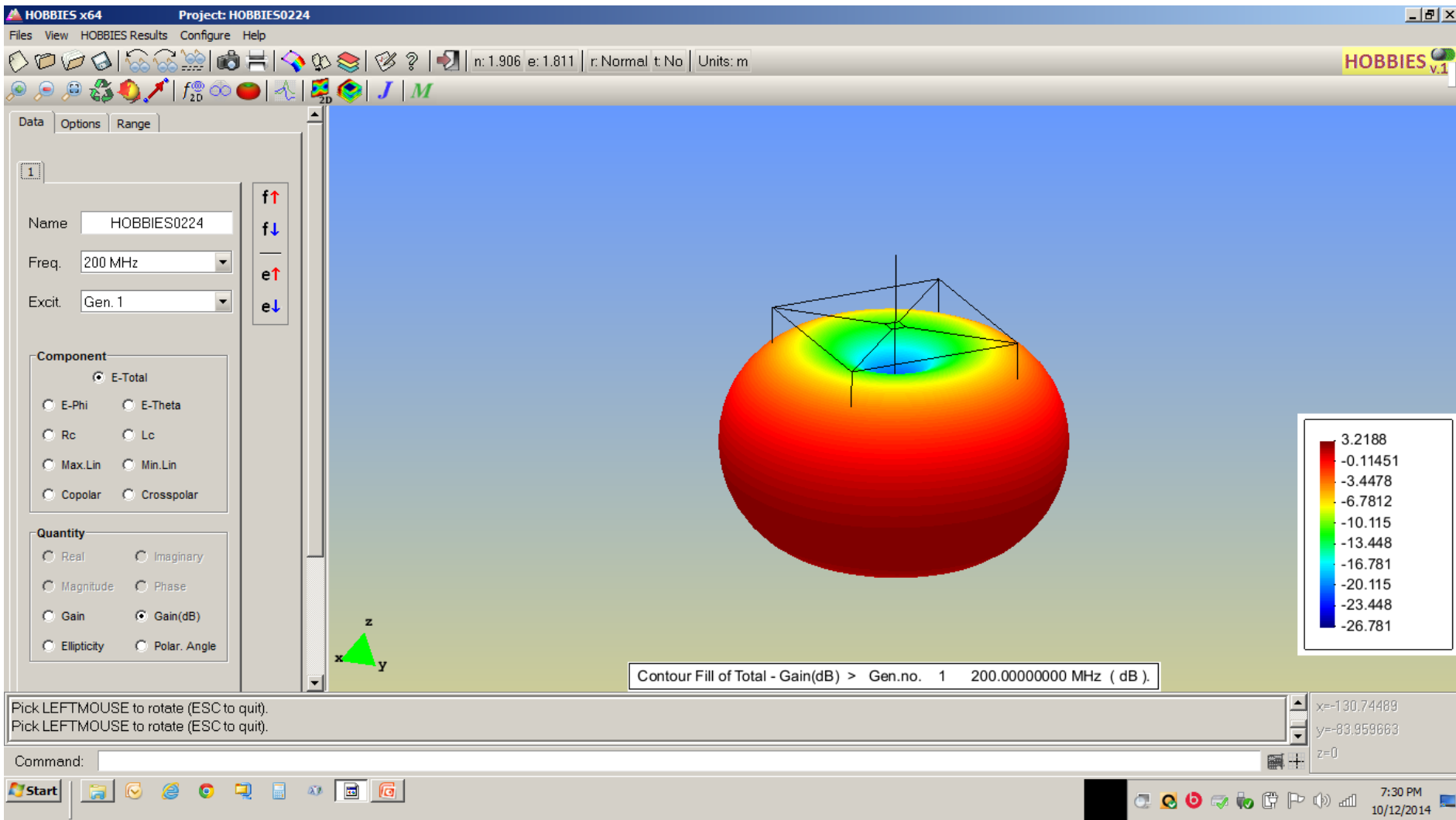



# Antenna Pattern at 335 MHz

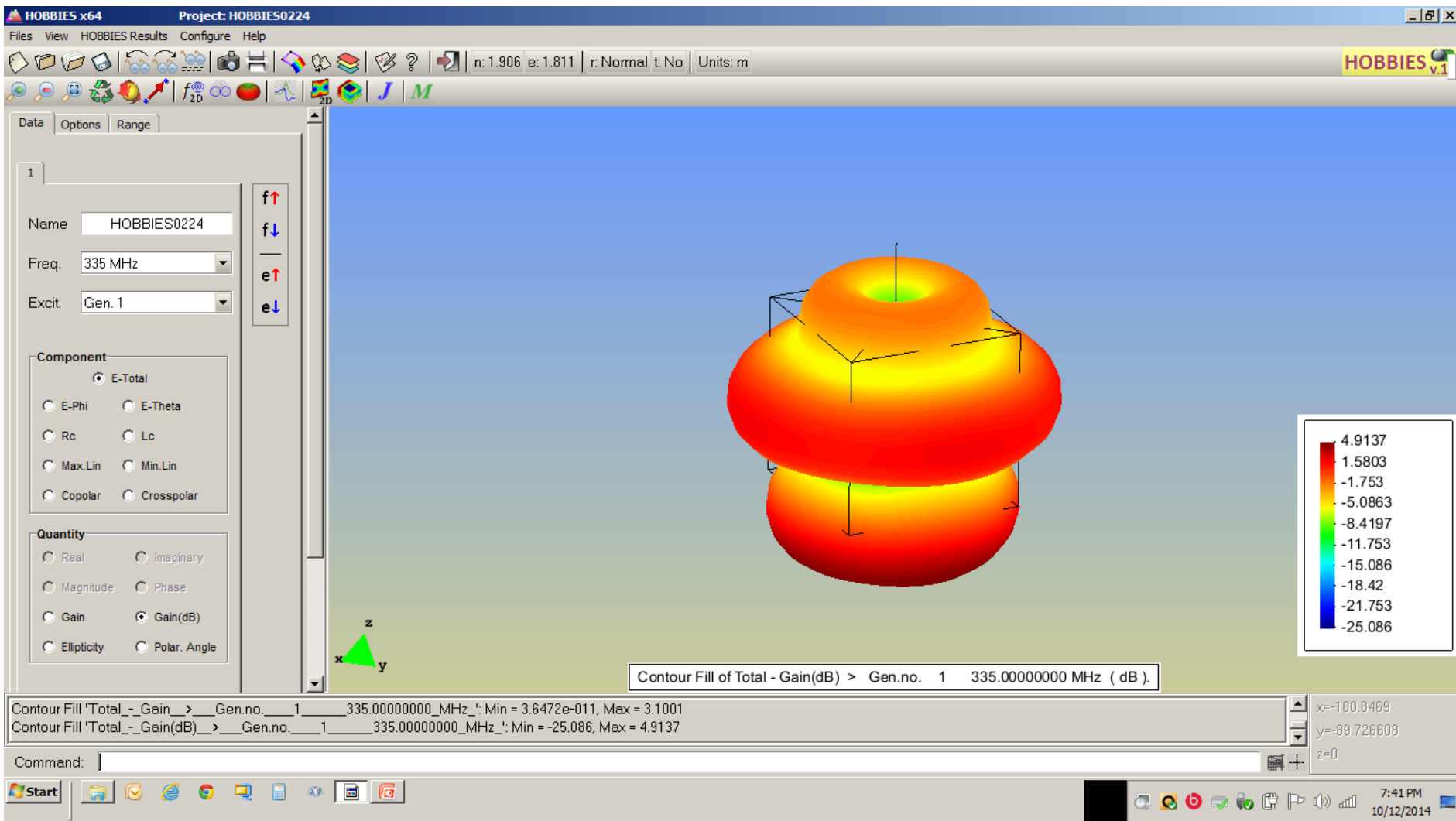

# Impedance versus Frequency

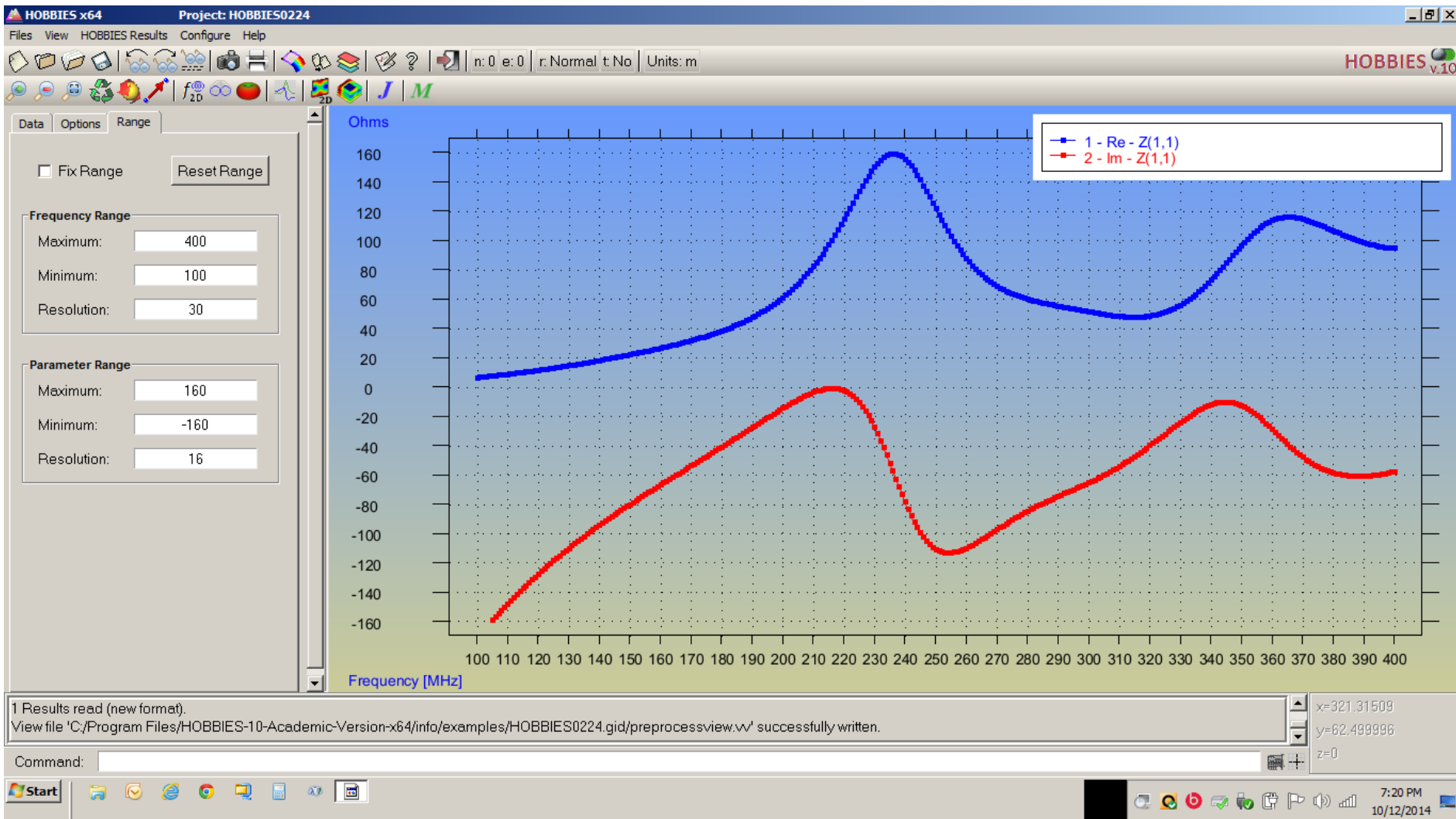

# How to Extract Impedance Data from HOBBIES

HOBBIES Postprocessor .ad1 File Format: 9 data columns

Frequency	G[mS]	S[mS]	R[ohms]	X[ohms]	S <sub>11</sub>	∠S <sub>11</sub>
> MHz						
0.1000E+01	1 1	0.2452E-03	0.3621E+00	0.1870E+01	-0.2762E+04	0.9993E+00 -0.3620E-01
0.1050E+01	1 1	0.3008E-03	0.3816E+00	0.2066E+01	-0.2621E+04	0.9992E+00 -0.3815E-01
0.1100E+01	1 1	0.3659E-03	0.4013E+00	0.2272E+01	-0.2492E+04	0.9992E+00 -0.4012E-01
⋮						

## HP/EEsof Touchstone® .s1p File Format

! Dipole computed 9/25/2016  
 ! Len=98.357 ft., Dia=0.10717 in.

#	MHz	Z	RI	R	1
1.000		1.8700195E+00		-2.7616719E+03	
1.050		2.0657369E+00		-2.6205186E+03	
1.100		2.2718233E+00		-2.4917314E+03	
⋮					



- Open .ad1 file in Microsoft Word
- Remove all extra spaces
- Convert text to table
- Delete unnecessary columns
- Copy/paste to Excel
- Change number format
- Copy/paste back to Word table
- Convert table to text
- Add comment and header lines
- Save as text file
- Change file extension to .s1p

---

# **Field Strength Inside Car for 2-meters Mobileers**

**FEKO**

# FEKO Featured in QST, October 2016

## Near Fields of a Mobile Mounted 2 Meter Antenna

The author uses **FEKO**, a patch-based computational software package, to reveal EM fields around a vehicle.

Keith Snyder, K16BDR

*FEKO* is a computational electromagnetic (CEM) tool that I used to calculate the antenna pattern of a 2 meter antenna located on the center of the roof of a sedan-type automobile. *FEKO* computer code can calculate the electromagnetic fields both inside and outside the vehicle. I show images of the near fields around the vehicle.

Many radio amateurs are familiar with modern NEC-based computer software like *EZNEC* and *4nec2* used to calculate the fields of wire antennas and wire structures in the presence of a ground.<sup>1,2,3</sup> These computer software codes facilitate antenna analysis as a function of frequency, antenna height above ground, along with antenna patterns in presence of wire models of structures. The *FEKO* computer code is similar in that, like the NEC codes, it uses the method of moments (MOM) and the Sommerfeld ground capabilities.

### FEKO Software

*FEKO* uses triangular patches in the models so that we can represent arbitrary shapes such as the metal skin of an automobile or aircraft. *FEKO* stands for "feldberechnung für körper mit beliebiger oberfläche," which translates from German to "field calculations for arbitrarily shaped structures."<sup>4</sup>

I first encountered *FEKO* at the Applied Computational Electromagnetics Society meeting in Monterey, California in 2003. I met Dr C. J. Reddy, who helped me model a rolled-edge discone antenna. Later, I met Dr. Ulrich Jakobus, who wrote the code as part of his research activities at the University of Stuttgart in 1991. Capabilities of *FEKO* software include

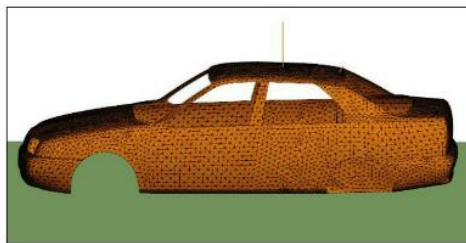

Figure 1 — Triangular patch model of a car includes a 19-inch wire antenna on the roof.

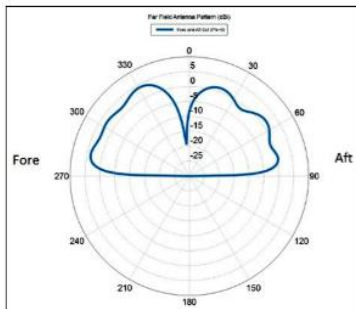

Figure 2 — Elevation pattern for a quarter-wave antenna on car at 147 MHz.

Finite Element Method (FEM), Method of Moments (MOM), Multi-Level Fast Multipole Method (MLFMM), Physical Optics/Geometrical Optics (PO/GO), and UTD (Uniform Theory of Diffraction).<sup>5</sup>

Steve Stearns, K6OIK, in a presentation to the Foothill Amateur Radio Society, has compared several CEM tools including a

few of the NEC software packages, along with *FEKO*.<sup>6</sup>

### The Vehicle Model

I found a generic car model on the *FEKO* software web page that is already meshed with simple triangle patches. I modeled a quarter-wave monopole antenna on the roof to see the near and far fields at 147 MHz. The 19-inch-tall monopole is located near the center of the roof. Figure 1 shows the patch model of a car with the monopole on the roof.

The car model is composed of 21,602 triangles. There are also 31 wire segments used to model the 2 meter monopole and a short antenna on the back of the roof

that is treated as a scatterer. The ground constants are a relative permittivity of 10, and conductivity of 0.005 S/m. The green plane under the car in Figure 1 indicates in *FEKO* that the Sommerfeld ground has been implemented.

The output of the computer code indicates that the antenna is near resonance with an

# Car with 2-Meter Monopole on Roof

---



Courtesy of Keith Snyder, KI6BDR

# Skin Currents

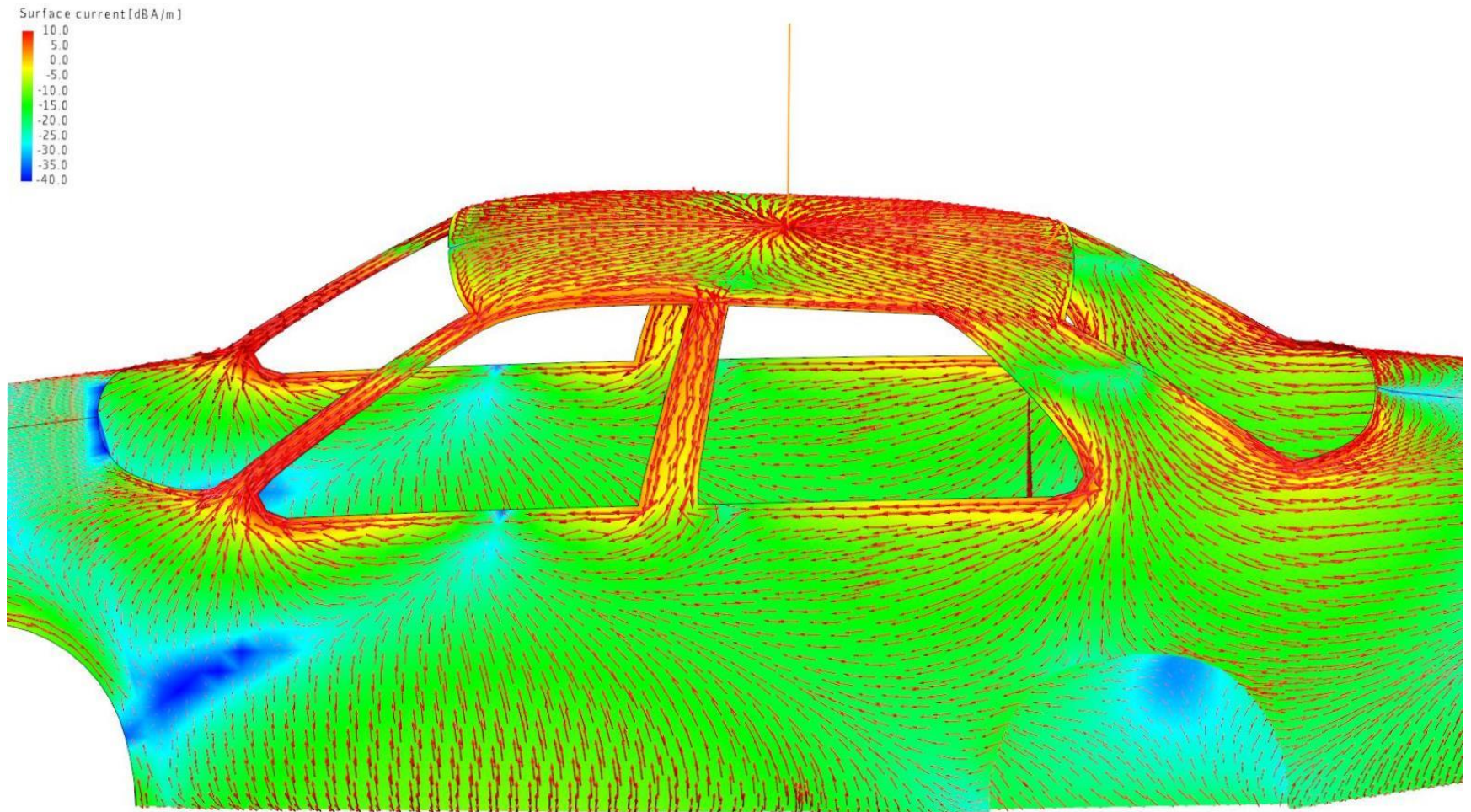

Courtesy of Keith Snyder, KI6BDR

# Electric Field Strength in Longitudinal Plane

XYZ E-Field [V/m]

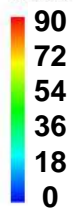

Transmit power 75 watts

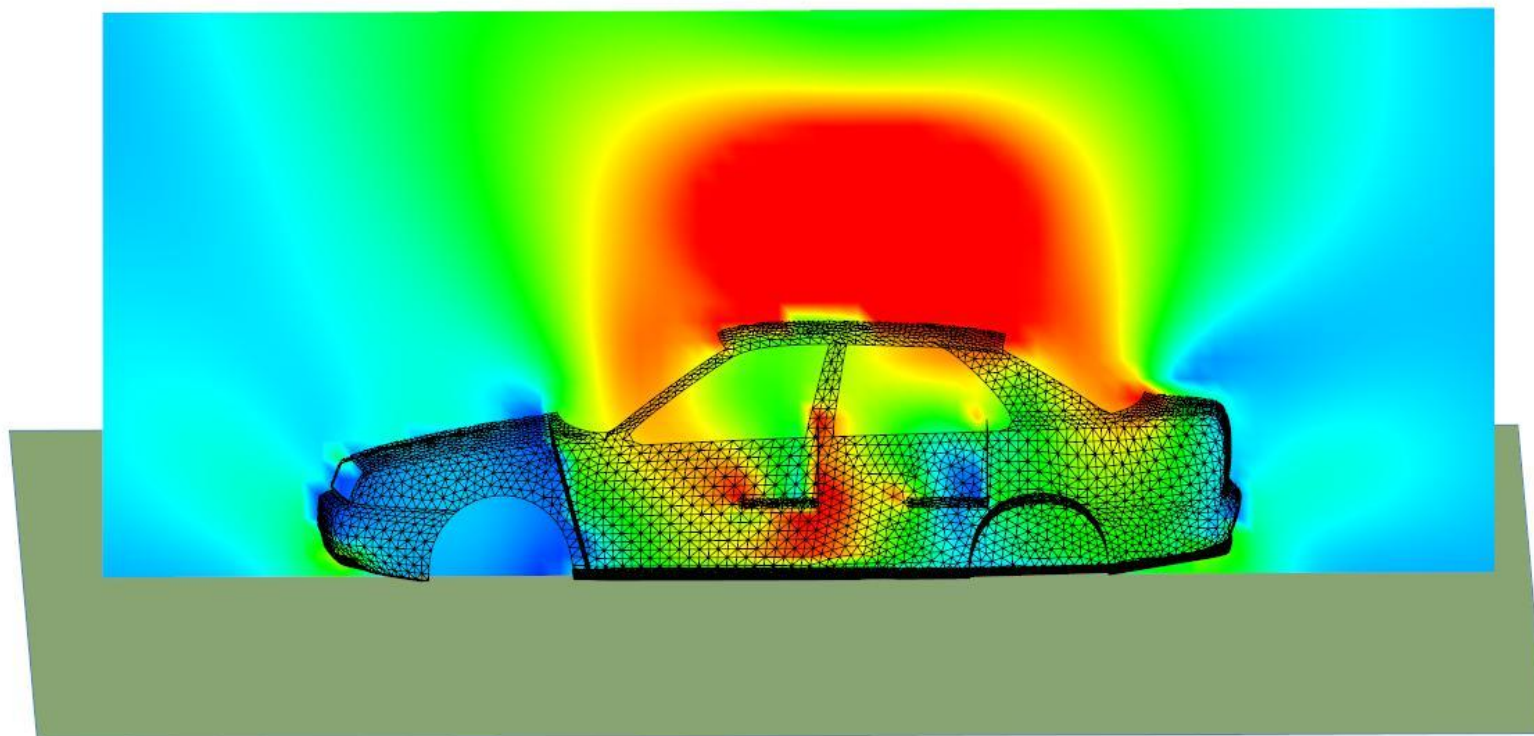



# Electric Field Strength in Transverse Plane

XYZ E-Field [V/m]

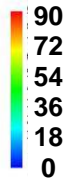

Transmit power 75 watts

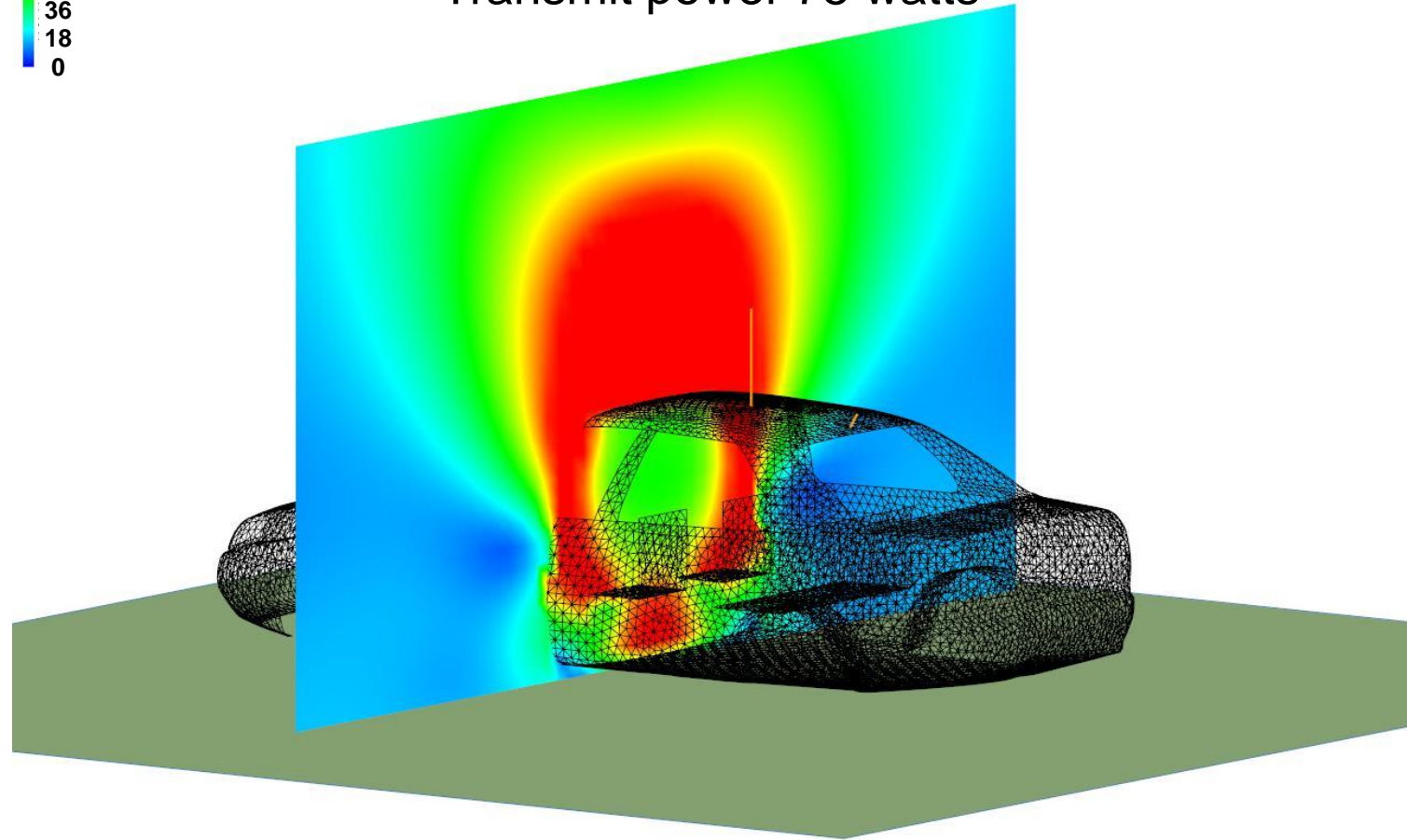

# Generic Car in HOBBIES

- Import .STL mesh file
- Convert .STL mesh to NURBS geometry
- Remesh using HOBBIES unstructured mesher
  - 2,903 nodes
- Add monopole in center of roof
  - Frequency 146 MHz
  - Length = 48.8 cm
  - Diameter = 4 mm
- Run HOBBIES
  - 5,664 unknowns
  - 92.3 seconds (pattern only)
  - 128.3 seconds (currents, pattern, near fields)
- Differences from FEKO model – minor stuff
  - Ground model turned off
  - Input power
  - Scaling of far field pattern shapes
  - Color sequence of pseudocolor scale

# Quadrilateral Bilinear Surface Mesh

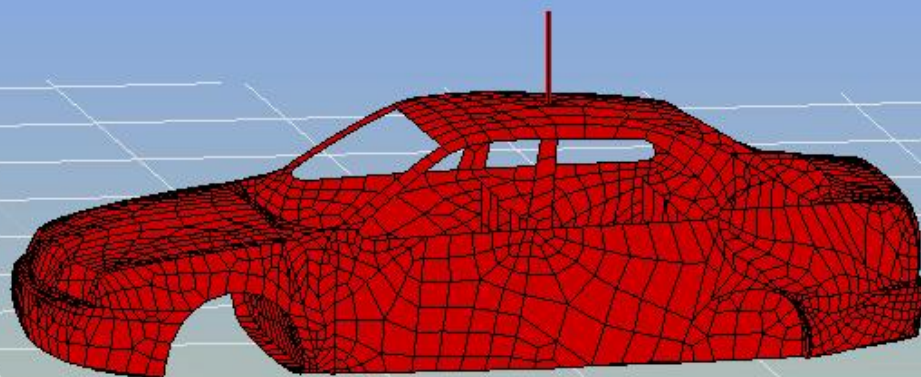

Ground model is off. Car is in free space.



# Pattern – Max Gain 2.713 dBi

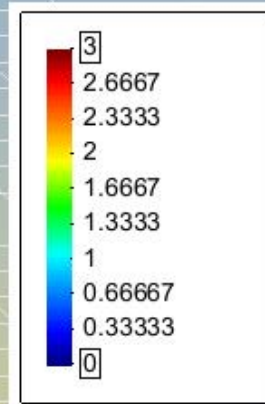
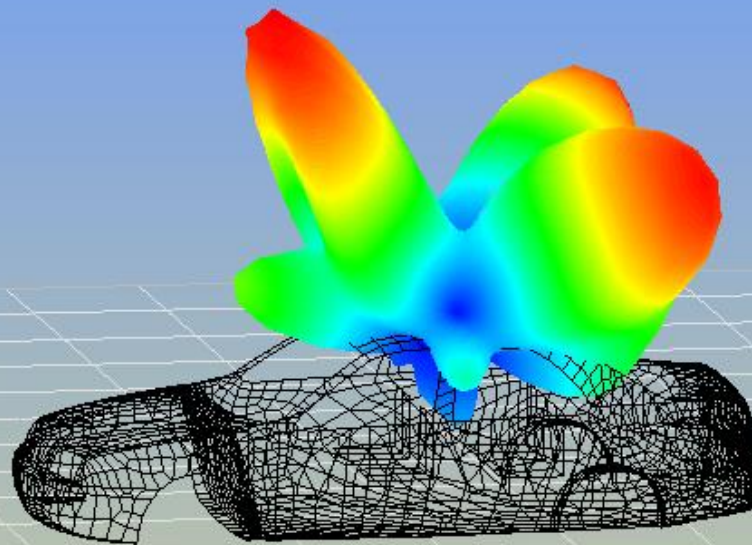

Contour Fill of Total - Gain > Gen.no. 1 146.00000000 MHz ( U ).



# |E| Field in Central Plane (y = 0)

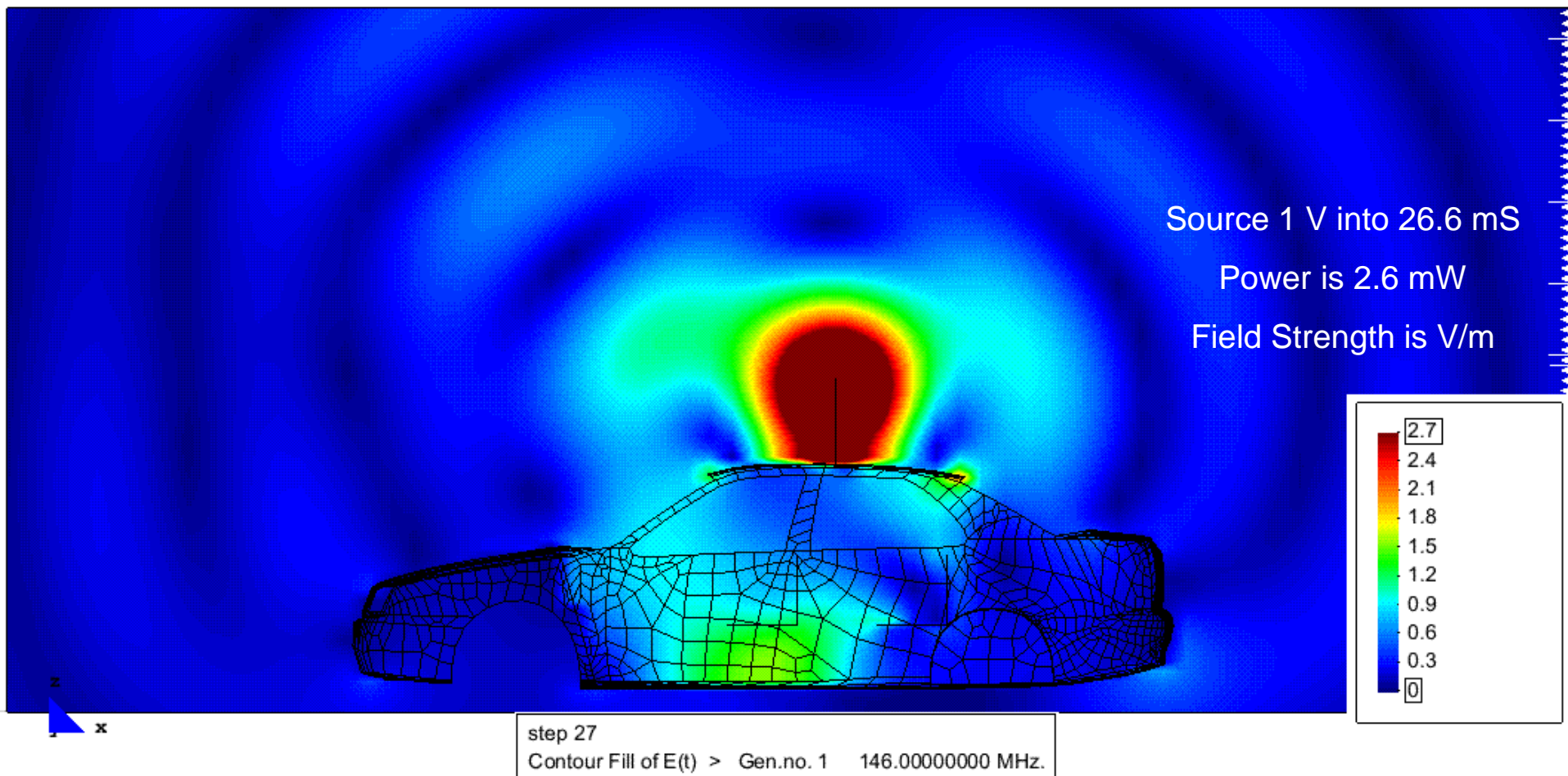

View PowerPoint in Slide Show mode (Shift F5) to see field animation.

# Summary

---

- **A car is not a Faraday cage**
  - Many Amateurs use 2-meter HTs from inside their cars
- **A car's cabin is an irregularly shaped cavity resonator with apertures (windows)**
- **Windows couple exterior and interior fields at 2 meters**
- **Currents around apertures couple exterior and interior fields**
- **Electric and magnetic fields inside a car can be measured and computed by modern CEM software**
- **Measurement and computation have good agreement if**
  - Measurements are made carefully
  - Computer model has good detail
- **Modern CEM tools give radio amateurs new capabilities**
  - Model surfaces more accurately than wire grid models
  - Include dielectric objects and surfaces in models
  - Compute fields in and around objects with high accuracy

---

# **Baking a Potato**

**MEFiSTo**

# Potato In Microwave Oven

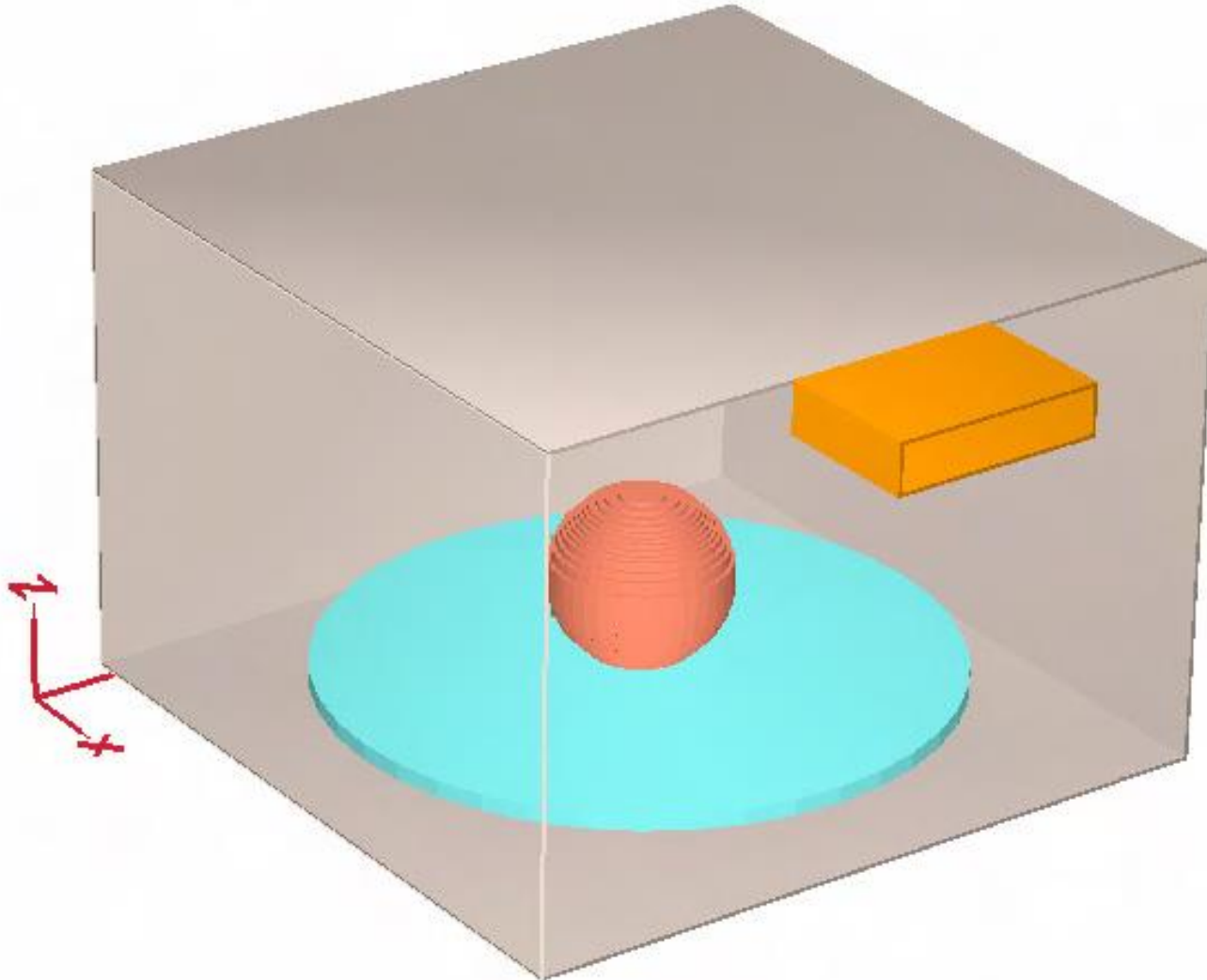

Courtesy of Faustus Scientific Corporation



# Dimensions

## Potato

Uniform lossy sphere

Diameter = 63 mm (2.5 in)

Volume = 131 cm<sup>3</sup>

(tennis ball size)

$\epsilon_r = 65 - j 20$

Density = 1 g/cm<sup>3</sup>

Mass = 131 g (4.6 oz)

Turntable: dielectric

$\epsilon_r = 2.55 - j 0$

Oven walls: PEC

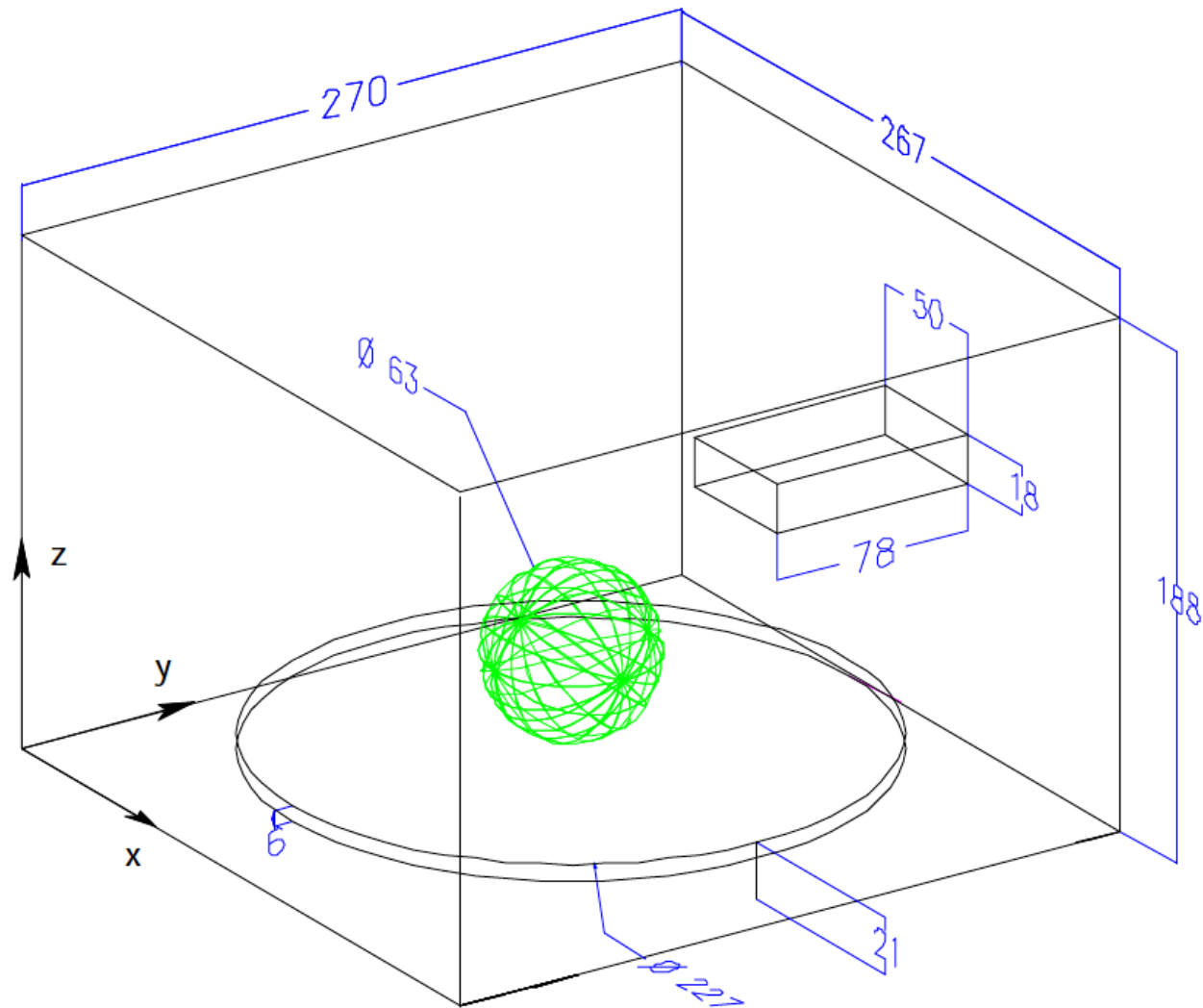

Courtesy of Faustus Scientific Corporation

# Electric Field $|E_z|$ inside Oven and Potato

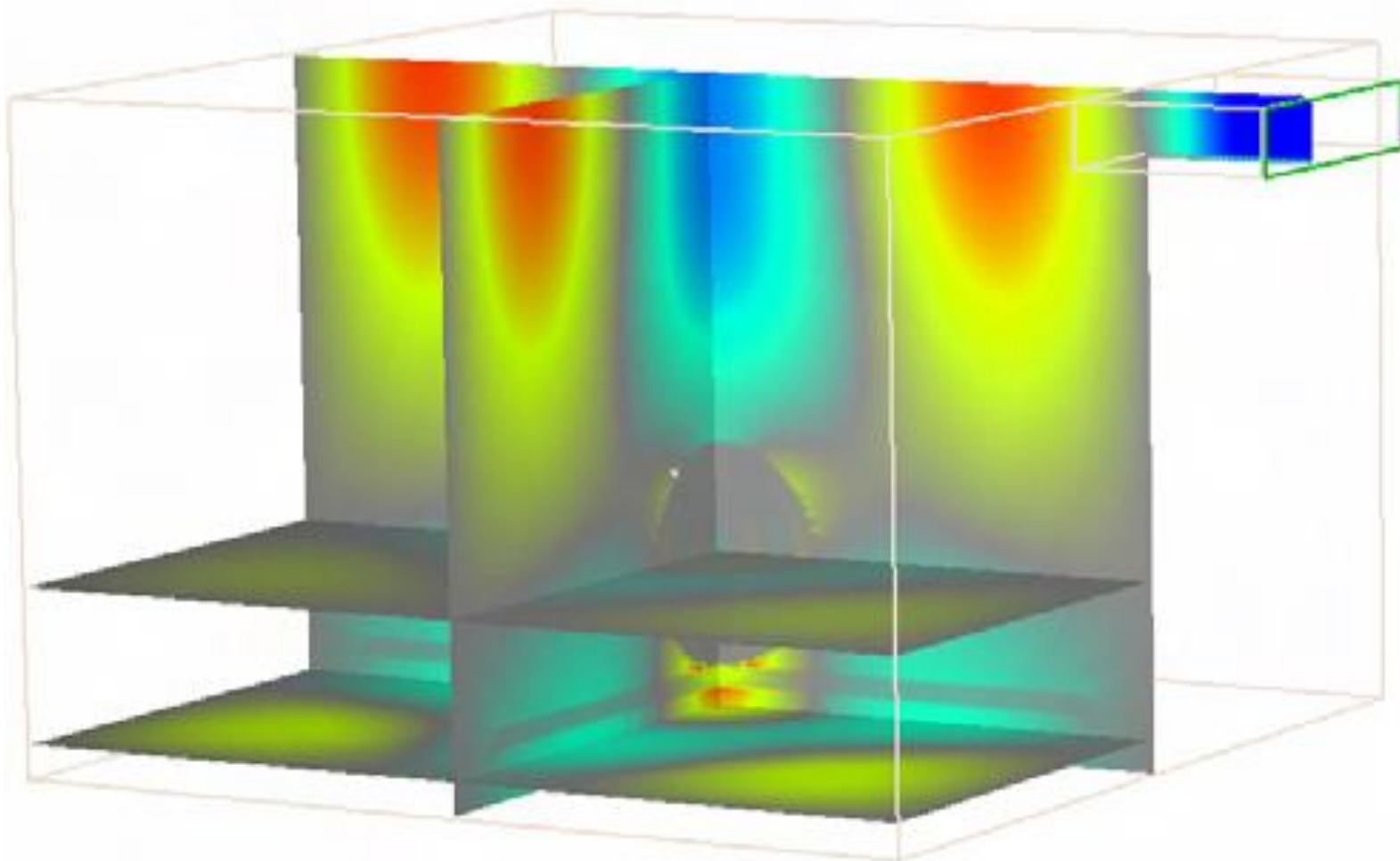

Courtesy of Faustus Scientific Corporation

# Magnitude of Electric Field $|E|$ inside Oven and Potato

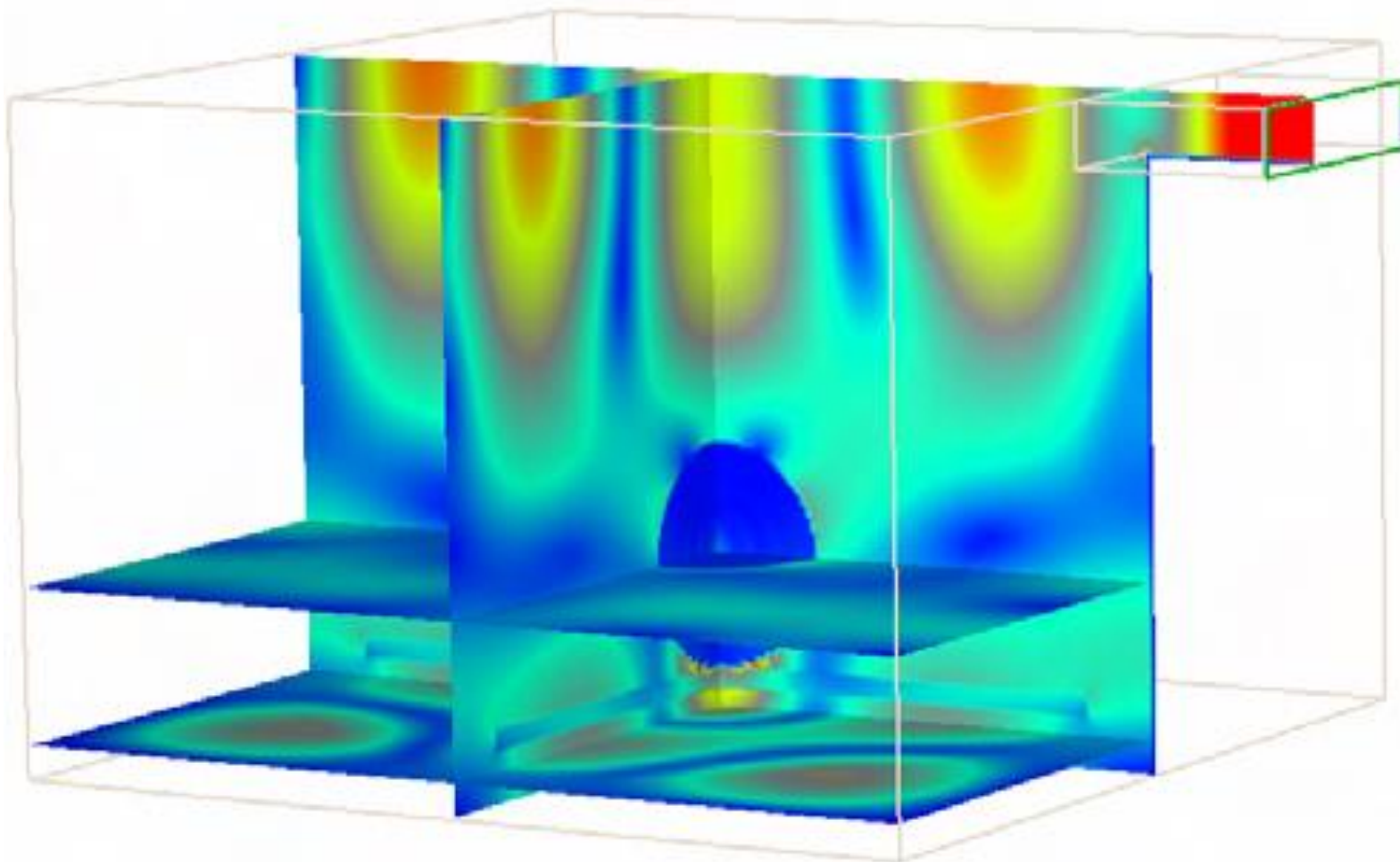

Courtesy of Faustus Scientific Corporation

# Electric Field Strength in Potato

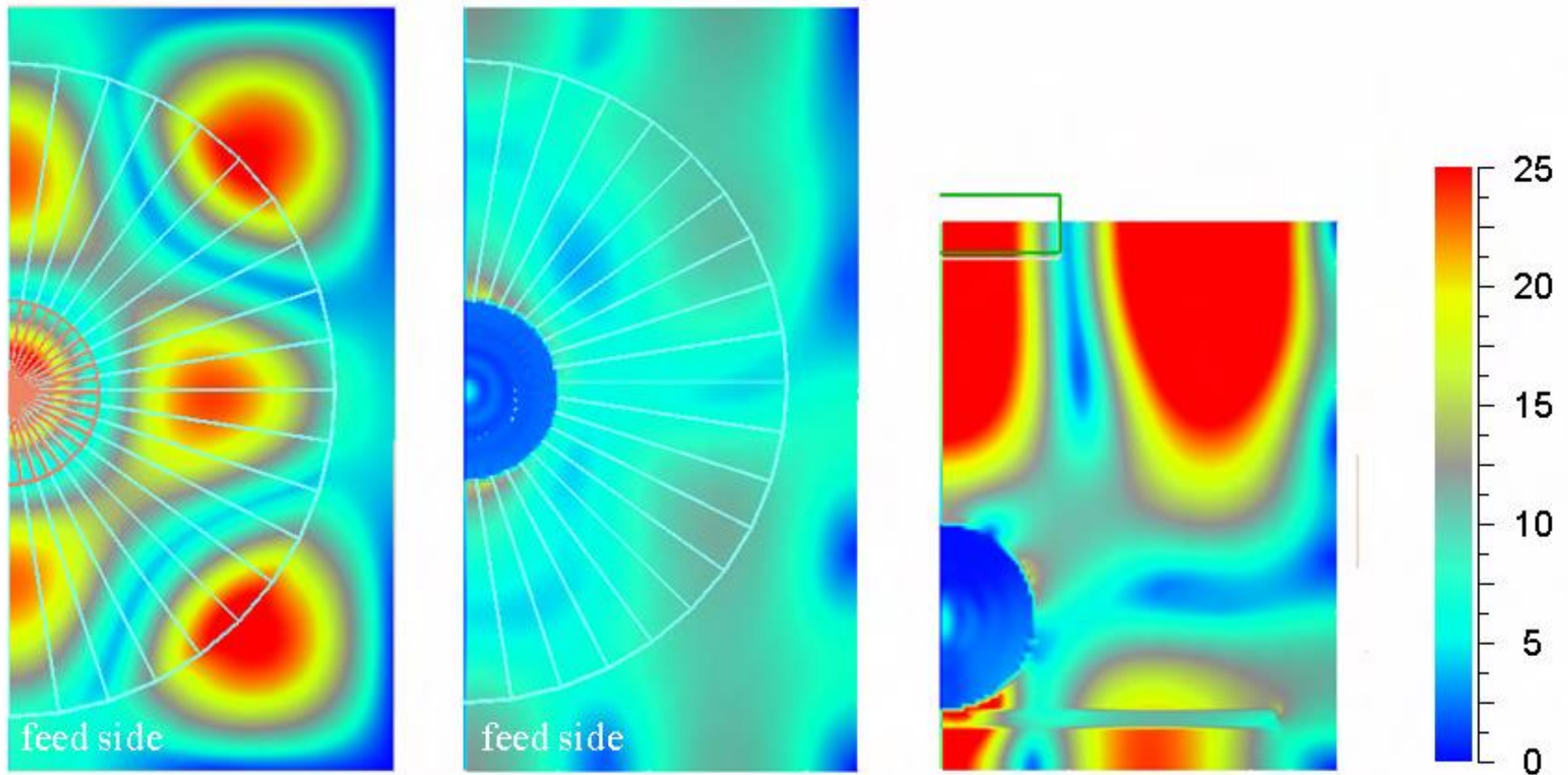

Courtesy of Faustus Scientific Corporation

# Specific Absorption Rate (SAR) of Potato

Potato cooks unevenly  
Bottom cooks faster than top  
Center hot spot due to focusing

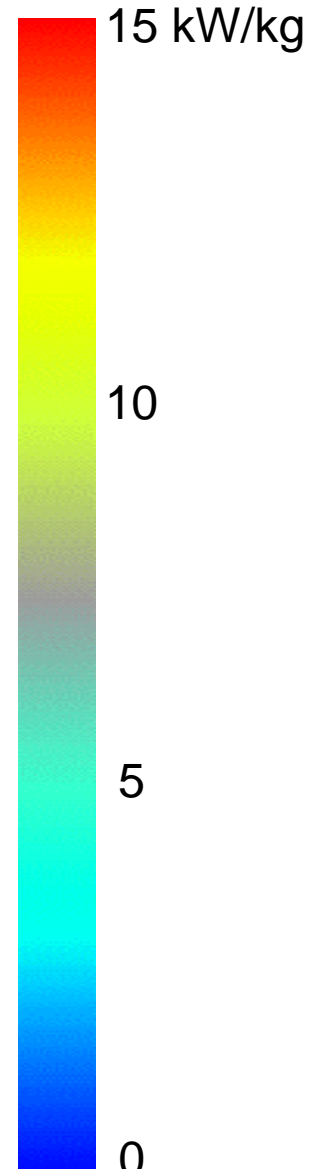
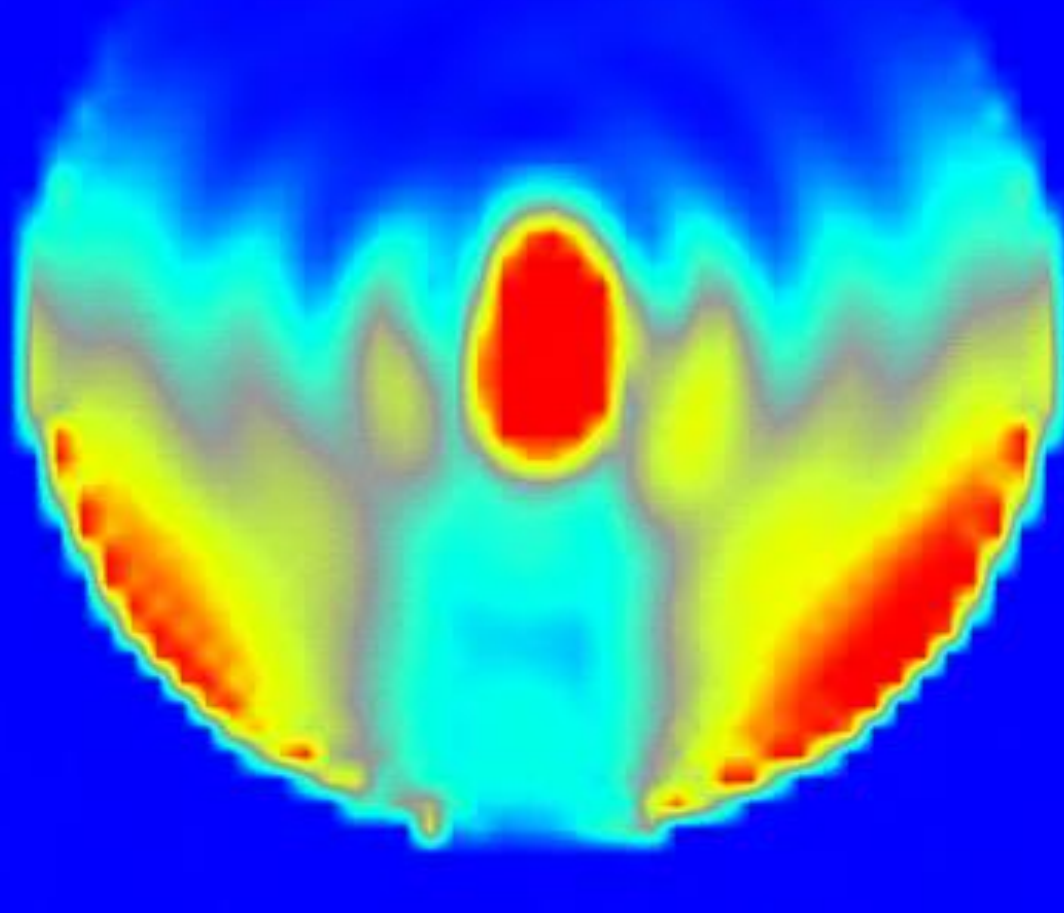

# Potato's SWR

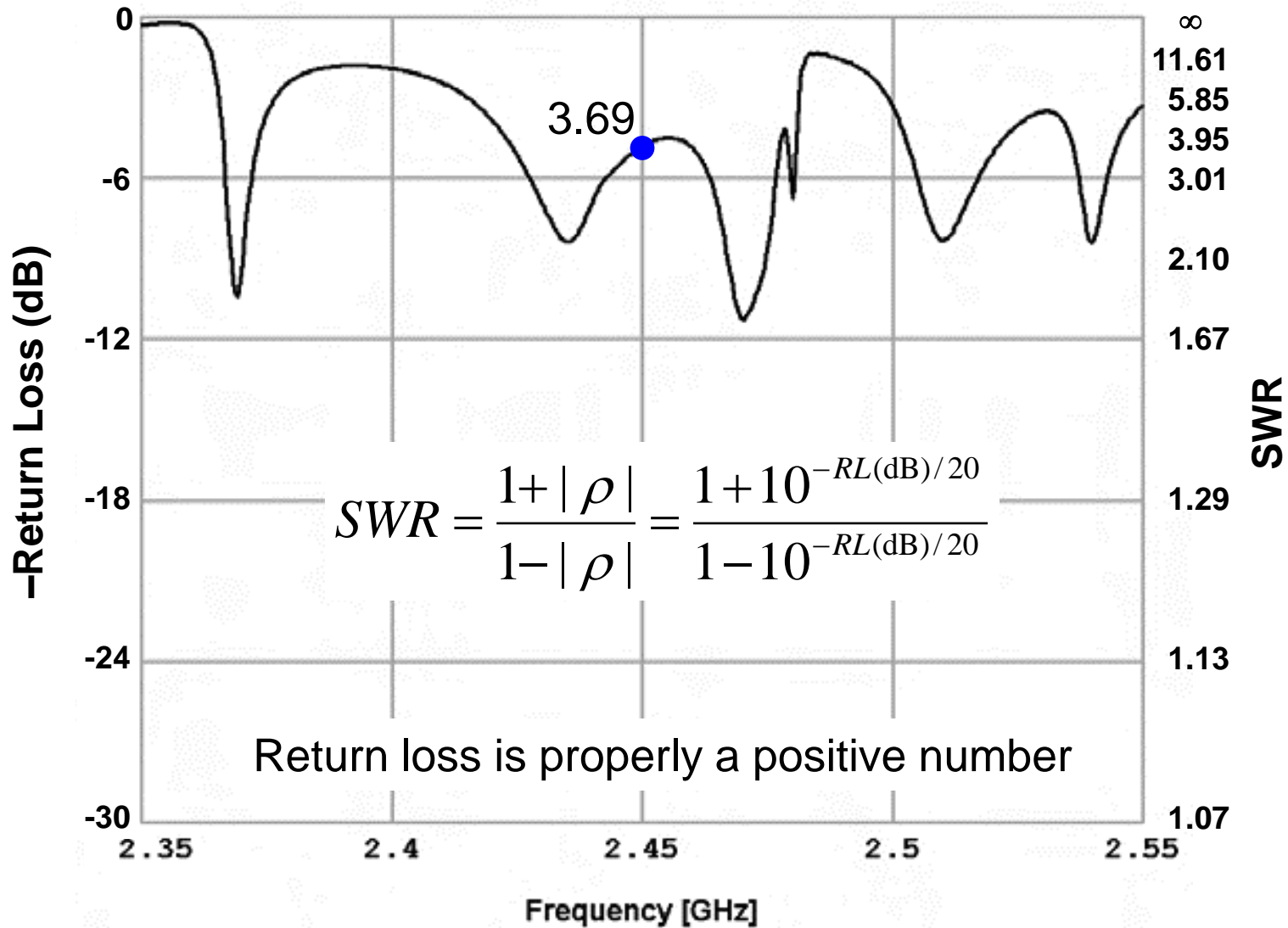

# Potato's SAR

- **RF parameters at 2.45 GHz (12.2 cm)**

- Return Loss = +4.83 dB
- SWR = 3.69
- $P_{incident} = 1000 \text{ W}$
- $P_{reflected} = 329 \text{ W (32.9\%)}$
- $P_{absorbed} = 671 \text{ W (67.1\%)}$

- **Specific Absorption Rate (SAR) of potato**

- $$SAR_{avg} = \frac{P_{absorbed}}{V_{potato} \times \rho_{potato}} = \frac{671 \text{ W}}{0.131 \text{ kg}} = 5,125 \text{ W/kg}$$

- **Potato SAR is 3,200 × the uncontrolled MPE limit!  
(but only for 6-8 minutes)**

- FCC uncontrolled MPE limit is 1.6 W/kg

# Mr. Potato Head



Courtesy of Hasbro

Questions for lawyers and philosophers: Is the RF exposure controlled or uncontrolled? Does it depend on whether the potato knows it is in the oven?



---

# **Fields in People**

**FEKO, WiPL-D and XFDTD**

# No – Fields in People! Not a Field of People

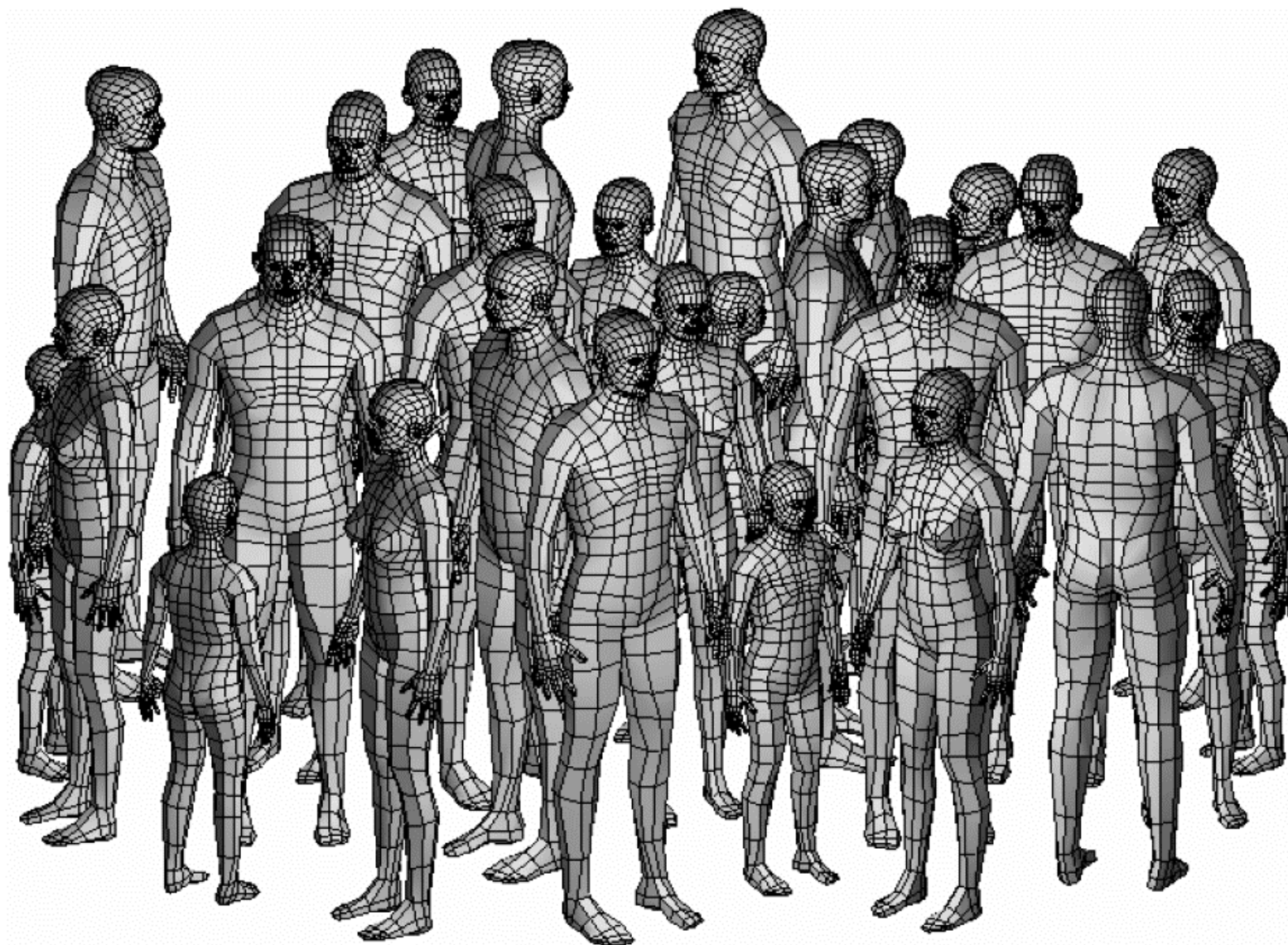

# No – Fields in People !

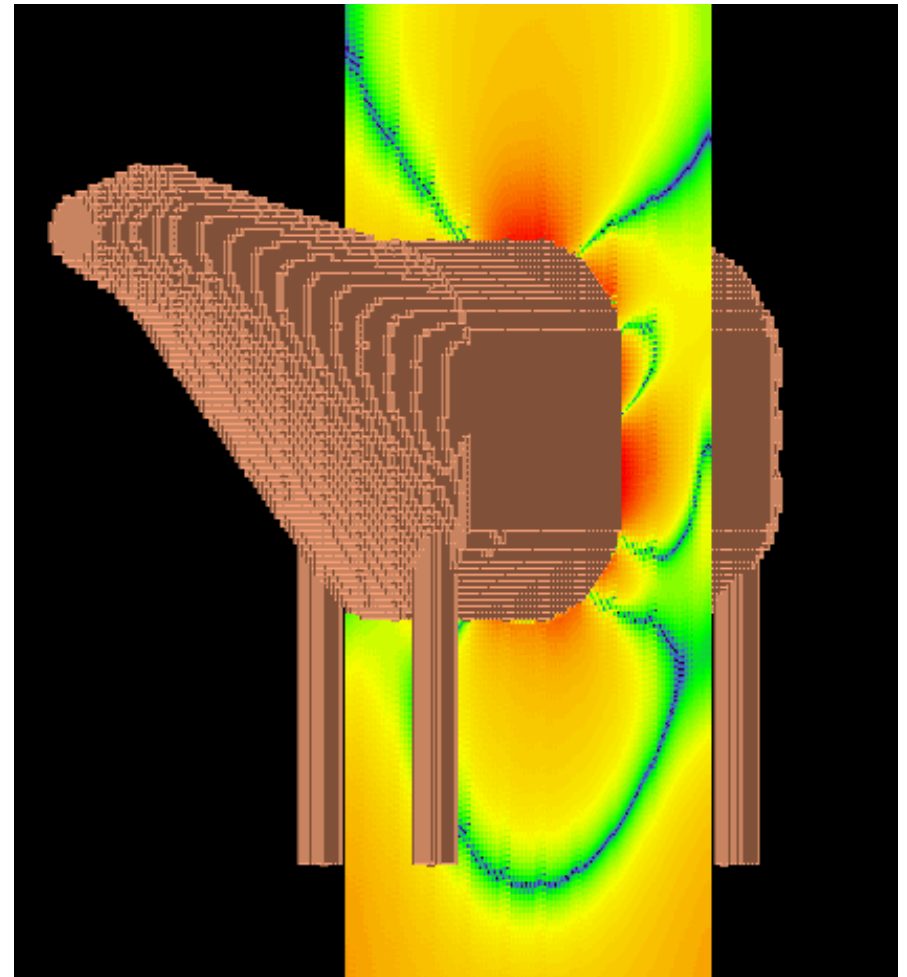
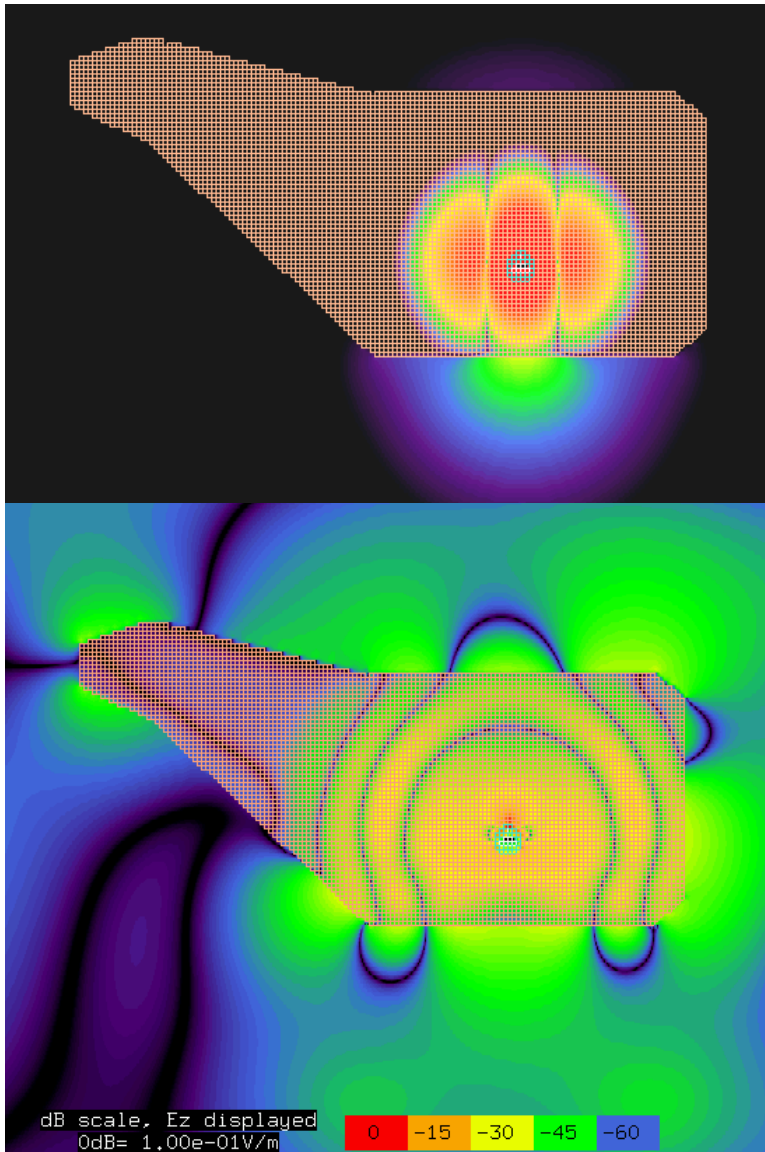

Transmitter Inside a Cow

# People Can Be Simple



	$\epsilon_r$	$\sigma$ S/m
Brain	43	1.5
Skull	15	0.6
Stuff	54	1.8

# People Can Be Complex

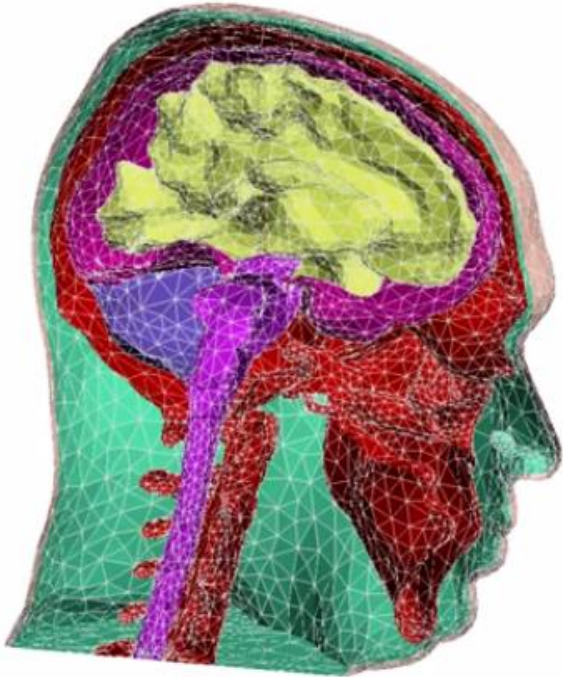

- **Male body phantom**

- 1 MHz to 20 GHz
- Tetrahedral size 12.3 mm
- 12 tissue types

- **Head phantom**

- Tetrahedral size 8.3 mm
- 8 tissue types



Courtesy of EMSS/Altair

# People Can Be Very Complex

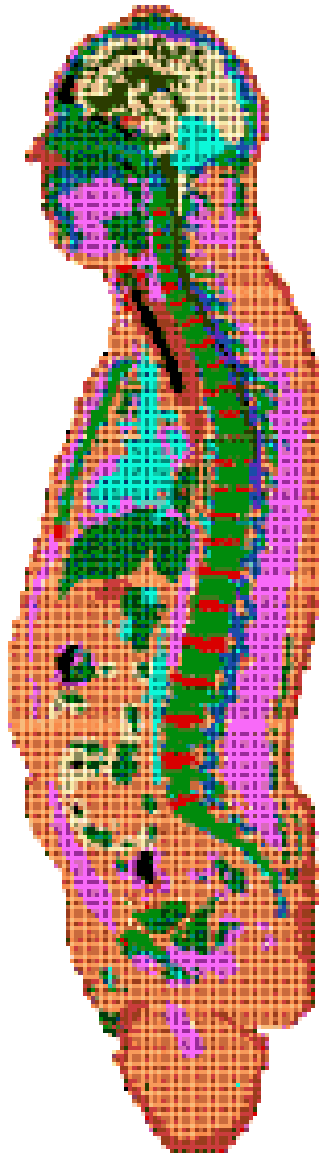

- **Male body phantom**
  - 1 MHz to 20 GHz
  - 4 million voxels (EM not biological)
  - 23 tissue types
- **Head phantom**
  - 8 million voxels
  - 17 tissue types

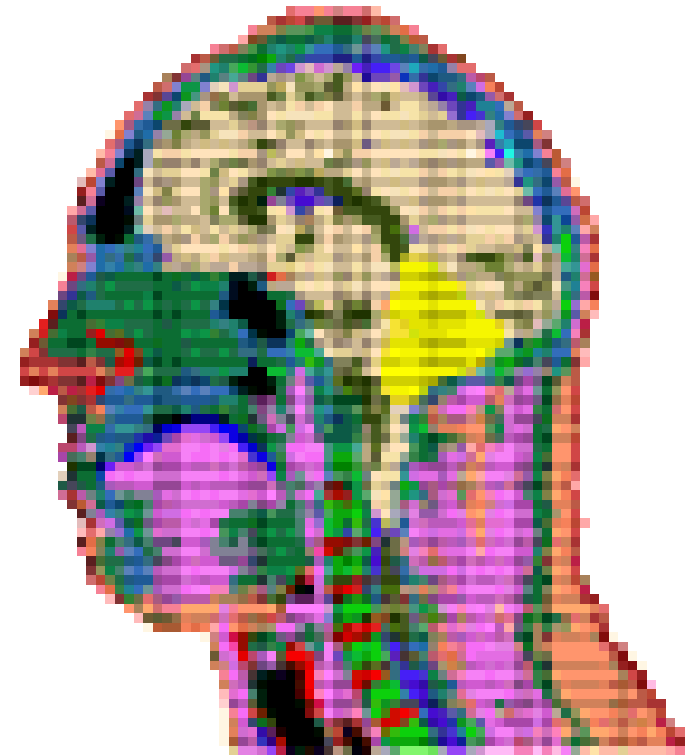

Courtesy of Remcom

# Tissue Parameters for Simple People

Frequency = 2,450 MHz

Tissue Type	$\epsilon_r$	$\sigma$ S/m	Density kg/m <sup>3</sup>
Average Brain	42.538925	1.511336	1030.0
Average Skull	14.965101	0.599694	1850.0
Average Muscle	53.573540	1.810395	1040.0

Source: FCC, Body Tissue Dielectric Parameters

<https://www.fcc.gov/general/body-tissue-dielectric-parameters>

# Tissue Parameters for Very Complex People

Tissue Type	$\epsilon_r$	$\sigma$
Bladder	18.000759	0.685294
Blood	58.263756	2.544997
Bone Cancellous	18.548979	0.805112
Bone Cortical	11.381223	0.394277
Bone Marrow Infiltrated	10.308158	0.458822
Bone Marrow Not Infiltr	5.296872	0.095031
Breast Fat	5.146670	0.137039
Cartilage	38.771160	1.755682
Cerebellum	44.803696	2.101270
Cerebro Spinal Fluid	66.243279	3.457850
Colon (Large Intestine)	53.878193	2.038204
Cornea	51.614494	2.295194
Dura	42.035004	1.668706
Eye Tissue (Sclera)	52.627628	2.033048
Fat	5.280096	0.104517
Fat (Mean)	10.820482	0.267954
Gall Bladder	57.633728	2.059032
Gall Blad Bile	68.360931	2.800733
Grey Matter	48.911255	1.807664
Heart	54.814018	2.256186
Kidney	52.742668	2.429709
Lens Cortex	44.625317	1.504036









Tissue Type	$\epsilon_r$	$\sigma$
Lens Nucleus	33.973507	1.086901
Liver	43.034443	1.686411
Lung (Inflated)	20.476801	0.804128
Lung (Deflated)	48.380974	1.682395
Muscle (Parallel Fiber)	54.417614	1.882011
Muscle (Transverse Fiber)	52.729469	1.738781
Nerve (Spinal chord)	30.145145	1.088474
Ovary	44.699692	2.263874
Skin (Dry)	38.006660	1.464073
Skin (Wet)	42.852562	1.591928
Small Intestine	54.424351	3.172779
Spleen	52.449310	2.238070
Stomach Esop Duodenum	62.158325	2.210518
Tendon	43.121975	1.684531
Testis Prostate	57.550518	2.167421
Thyroid Thymus	57.200367	1.967798
Tongue	52.627628	1.802514
Trachea	39.732574	1.448737
Uterus	57.813835	2.246464
Vitreous Humour	68.208023	2.478094
White Matter	36.166599	1.215008

Frequency = 2,450 MHz Source: FCC

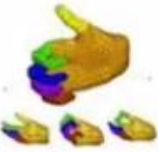

# Free People!

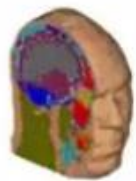
Download Free From [www.FEKO.info](http://www.FEKO.info)

Articulated (parametric) Human (SEP)	Standing Human (FEM)	Articulated Hand (SEP)	IEEE Head (SEP)	Visible Human Full Model (Inhomogeneous FEM)	Visible Human Head and Shoulders (Inhomogeneous FEM)	Visible Human Head (Inhomogeneous FEM)	IEEE SAM (Homogeneous FEM)	Hugo (4 Organs FEM)
<p>Using geometry cards in EDITFEKO. Parametric i.e. change positions, sit, stand, raise arms, bend legs etc. The mesh size will change with frequency and has been tested up to 900 MHz.</p>	<p>Model is based on the Articulated Human. The model consists of 334,733 tetrahedrals (8mm size) and can be used for runs up to 1GHz. Requires more than 2 GByte of RAM.</p>	<p>Using geometry cards in EDITFEKO. Change position of fingers, 16 degrees of freedom. (Tested up to 1800 MHz)</p>	<p>This CADFEKO model is a triangle mesh of the inner layer of the IEEE SAM phantom. The minimum triangle length is 10mm. The model is set up for 1800 MHz. +- 2 GByte of RAM required.</p>	<p>The model contains 2.2 mil tetrahedrals (8mm size) and is suitable up to 1GHz. Requires a 64bit machine and will use +- 10 GByte of RAM.</p>	<p>The model contains 300,000 tetrahedrals (8mm size) and can be used up to 1 GHz. Can be solved on a 32bit machine with 2 GByte of RAM.</p>	<p>The model contains 900,000 tetrahedrals (4mm size) and can be used up to 2GHz. Requires a 64bit machine and will use more than 2 GByte of RAM.</p>	<p>5mm tetrahedral mesh of the older IEEE SAM phantom and a 20mm tetrahedral mesh air box around the head. The model is set up for 1800 MHz. Requires +- 1.4 GByte of RAM (with hertzian dipole as antenna (MoM)).</p>	<p>The model has 5 different media: brain, lungs, eyes, muscle and an outer air shell. The model contains 749,507 tetrahedrals (8mm size) and can be used up to 1GHz. Requires more than 2 GByte of RAM.</p>
								

Courtesy of Altair

# Quadrilateral Surface Meshed Homogeneous Phantom

---



Courtesy of WiPL-D

# Introducing SAM Specific Anthropomorphic Mannequin

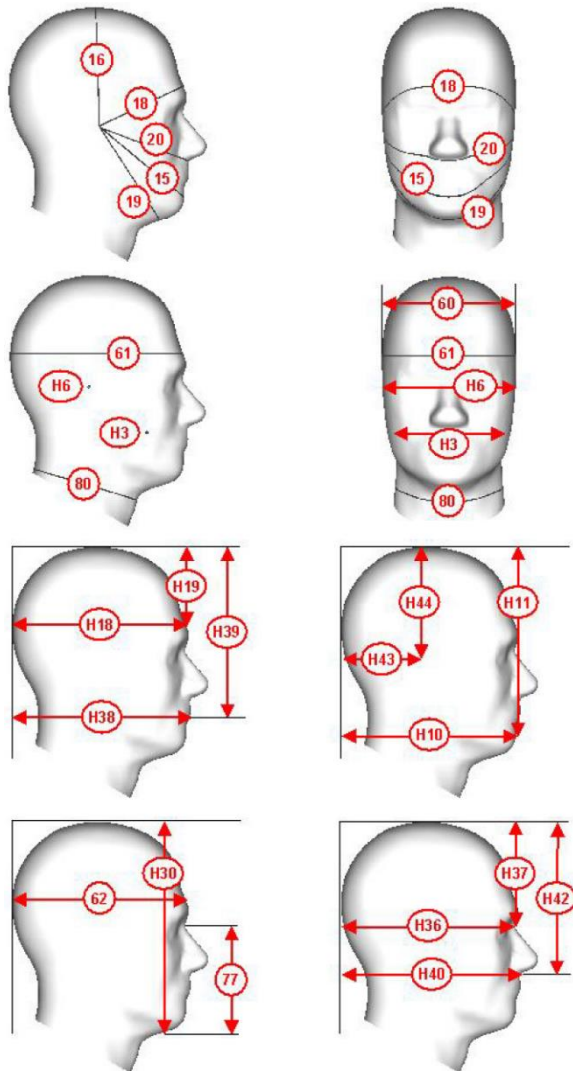

IEEE Standard 1528-2013

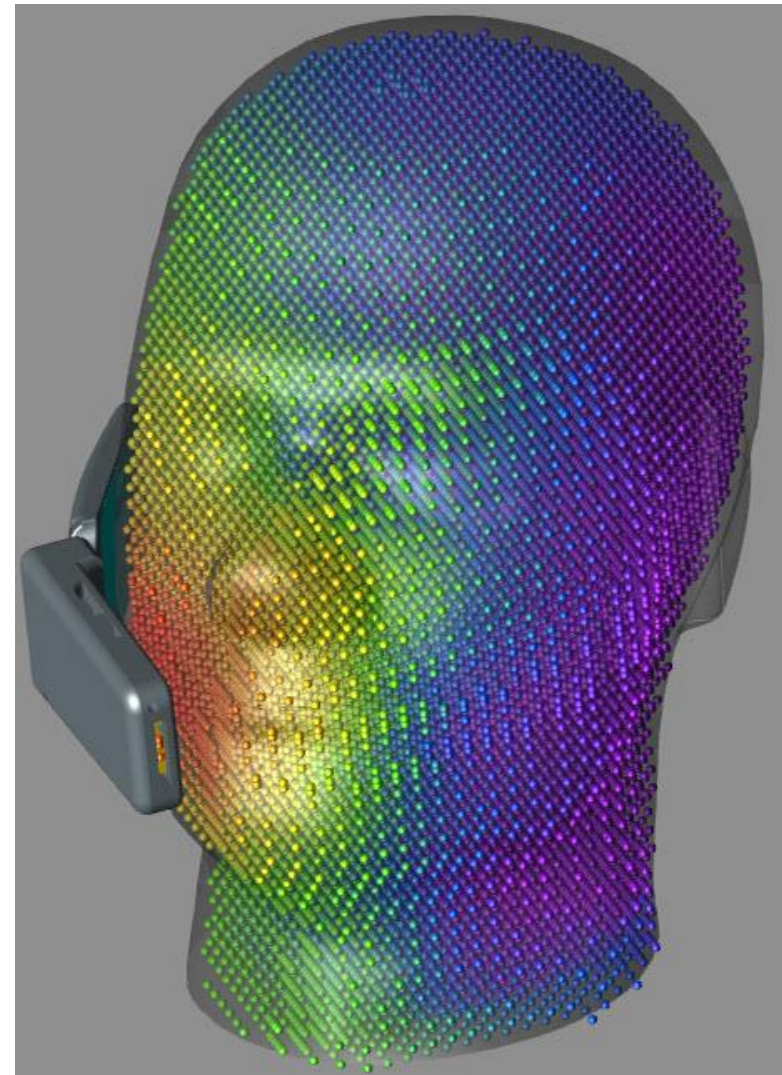

Courtesy of Remcom

# Field Strength and SAR in Phantom Head

abs(E) [V/m] X=0.03

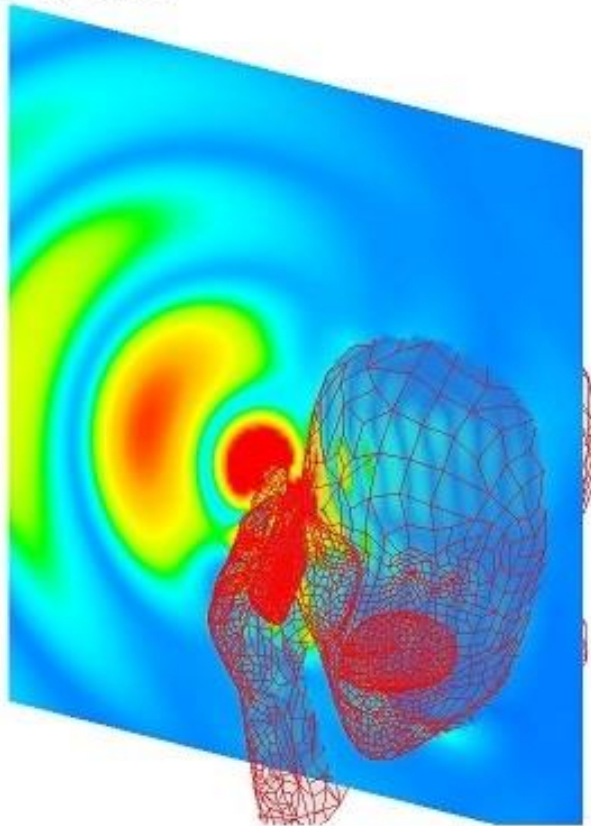

SAR [mW/m] X=0.02

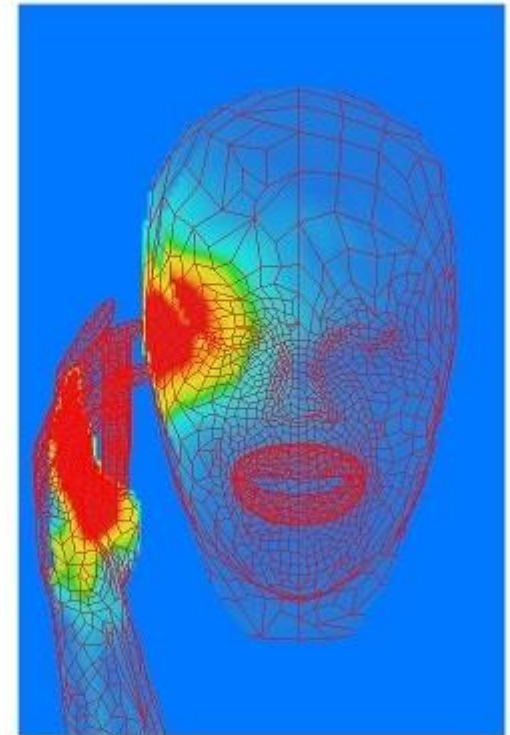

- **Specific Absorption Rate (SAR)**
  - Units: watts/kilogram (W/kg)
- **Peak SAR (averaged over a gram) must not exceed**
  - Controlled exposure: 8.0 W/kg
  - Uncontrolled exposure: 1.6 W/kg

Courtesy of WiPL-D

---

# References and Resources

# References

## ■ Current distribution on a wire

- K.K. Mei, "On the Integral Equations of Thin Wire Antennas," *IEEE Trans. Antennas and Propagation*, vol. 13, no. 3, pp. 374-378, May 1965
- Erik Hallen, "Theoretical Investigations into the Transmitting and Receiving Qualities of Antennae," *Nova Acta Regiae Soc. Sci, Upsaliensis*, ser. IV, vol. 11, no. 4, pp. 1-44, 1938
- H.C. Pocklington, "Electrical Oscillations in Wires," *Cambridge Phil. Soc. Proc.*, vol. 9, pp. 324-332, 1897

## ■ Bubnov and Galerkin methods

- B.G. Galerkin, "Series Solution of Some Problems of Elastic Equilibrium of Rods and Plates," *Vestnik Inzhenerov i Tekhnikov*, vol. 19, pp. 897-908, 1915. (English translation: NTIS Rept. TT-63-18924)
- I.G. Bubnov, *Stroitel'naia Mekhanika Korablia* (Structural Mechanics of Shipbuilding), Tech. Rept., 1914

## ■ Method of Moments

- R.F. Harrington, "Origin and Development of the Method of Moments for Field Computation," *IEEE Antennas and Propagation Magazine*, June 1990
- R.F. Harrington, *Field Computation by Moment Methods*, Macmillan, 1968
- R.F. Harrington, "Matrix Methods for Field Problems," *Proc. IEEE*, Feb. 1967
- L.V. Kantorovich and G.P. Akilov, *Funktsional'nyj Analiz v Normirovannykh Prostranstvakh* (Functional Analysis in Normed Spaces), 1959. English translation: Pergamon, 1964.

# References

## ■ Antenna modeling theory – early years

- E.K. Miller, L. Medgyesi-Mitschang, and E.H. Newman, eds., *Computational Electromagnetics: Frequency-Domain Method of Moments*, IEEE Press, 1992
- R.C. Hansen, ed., *Moment Methods in Antennas and Scattering*, Artech House, 1990
- E.H. Newman and P. Tulyathan, *A Surface Patch Model for Polygonal Plates*, ADA119682, Apr. 1981; also *IEEE Trans. Antennas and Propagation*, July 1982
- N.N. Wang and J.H. Richmond, and M.C. Gilreath, “Sinusoidal Reaction Formulation For Radiation and Scattering from Conducting Surfaces,” *IEEE Trans. Antennas and Propagation*, May 1975
- A.R. Neureuther, et al., “Comparison of Numerical Methods for Thin Wire Antennas,” URSI meeting, Fall 1968
- R.L. Tanner and M.G. Andreasen, “Numerical Solution of Electromagnetic Problems,” *IEEE Spectrum*, Sept. 1967
- M.G. Andreasen and R.L. Tanner, *Investigation of General Wire Antennas*, Final Rept., AD0819198, TRG Division, CDC, Menlo Park, CA, Aug. 1967
- G.A. Thiele, “Calculation of the Current Distribution on a Thin Linear Antenna,” *IEEE Trans. Antennas and Propagation*, Sept. 1966
- J.H. Richmond, “Digital Computer Solutions of the Rigorous Equations for Scattering Problems,” *Proc. IEEE*, Aug. 1965

# References

## ■ Wire grid models

- A. Rubinstein, M. Rubinstein, and F. Rachidi, “A Physical Interpretation of the Equal Area Rule,” *IEEE Trans. Electromagnetic Compat.*, May 2006
- A.C. Ludwig, “Wire Grid Modeling of Surfaces,” *IEEE Trans. Antennas and Propagation*, Sept. 1987
- J.H. Richmond, “A Wire-Grid Model for Scattering by Conducting Bodies,” *IEEE Trans. Antennas and Propagation*, Nov. 1966

## ■ Rectangular patch models (flat)

- N.C. Albertsen, J.E. Hansen, and N.E. Jensen, “Computation of Radiation from Wire Antennas on Conducting Bodies,” *IEEE Trans. Antennas and Propagation*, Mar. 1974

## ■ Triangular patch models

- S.M. Rao, D.R. Wilton, and A.W. Glisson, “Electromagnetic Scattering by Surfaces of Arbitrary Shape,” *IEEE Trans. Antennas and Propagation*, May 1982

## ■ Quadrilateral models (curved)

- D.L. Knepp and J. Goldhirsh, “Numerical Analysis of Electromagnetic Radiation Properties of Smooth Conducting Bodies of Arbitrary Shape,” *IEEE Trans. Antennas and Propagation*, May 1972



# References

## ■ NEC

- Official NEC license page <https://ipo.llnl.gov/technologies/nec>
- Unofficial NEC Archives <http://nec-archives.pa3kj.com>
- G.J. Burke, *Ground Model Options in the NEC-4.2 Antenna Code*, Tech. Rept. 490316, Lawrence Livermore National Laboratory, July 2011
- G.J. Burke, E.K. Miller, and A.J. Poggio, "The Numerical Electromagnetics Code (NEC) – A Brief History," *IEEE Int. Symp. Antennas and Propagation*, June 2004
- R.P. Haviland, W4MB, "Programs for Antenna Analysis by the Method of Moments," *ARRL Antenna Compendium*, Vol. 4, ARRL, 1995
- G.J. Burke, *Numerical Electromagnetics Code (NEC-4.1) Method of Moments: Part I: User's Manual; Part II: Program Description-Theory*, Lawrence Livermore National Laboratory, Jan. 1992
- J.K. Breakall, G.J. Burke, and E.K. Miller, "The Numerical / Electromagnetics Code (NEC-3)," *EMC Symp.*, Zurich, Mar. 5-7, 1985
- G.J. Burke and A.J. Poggio, *Numerical Electromagnetics Code (NEC2), Part I: Program Description-Theory; Part II: Program Description-Code; Part III: User's Guide*, Lawrence Livermore National Laboratory, Jan. 1981

# References

- **EZNEC** <http://www.eznec.com>
  - “Antenna Modeling,” chapter 8 in *ARRL Antenna Book*, 23rd edition, ARRL, 2015
  - H.W. Silver, N0AX, *Antenna Modeling for Beginners*, ARRL, 2012
  - L.B. Cebik, W4RNL, “Modeling Software,” *QEX*, Sept. 2005 and Nov. 2005
  - L.B. Cebik, W4RNL, *ARRL Antenna Modeling Course*, ARRL, 2002
  - L.B. Cebik, W4RNL, “A Beginners Guide to Modeling with NEC,” *QST*, Nov. 2000, Dec. 2000, Jan. 2001, and Feb. 2001
  - L.B. Cebik, W4RNL, “How to Get the Most Out of Antenna Patterns,” *CQ Amateur Radio*, Jan. and Feb. 1999
- **4nec2** <http://www.qsl.net/4nec2>
  - C. Weixelbaum, WF5WBE, “Antenna Modeling with 4NEC2,” presentation to Heart O’ Texas ARC, May 2014, [http://www.hotarc.org/files/4NEC2\\_basic\\_modeling.ppt](http://www.hotarc.org/files/4NEC2_basic_modeling.ppt)
  - G. Kraus and H. Lau, “Simulation of Wire Antennas using 4NEC2: A Tutorial for Beginners,” version 1.0, Aug. 2010, [http://www.qsl.net/4nec2/Tutorial\\_4NEC2\\_english.pdf](http://www.qsl.net/4nec2/Tutorial_4NEC2_english.pdf)
  - R.S. Adams, “4NEC2 Tutorial: Electric Dipole Antenna Simulation,” Sept. 2009, [http://www.qsl.net/4nec2/NEC\\_tutorial1.pdf](http://www.qsl.net/4nec2/NEC_tutorial1.pdf)

# References

- **MININEC** <http://www.w8io.com/mininec.htm>
  - J.W. Rockway and J.C. Logan, N6BRF, “Wire Modeling Limitations of NEC and MININEC for Windows,” *QEX*, May/June 1998
  - L.B. Cebik, W4RNL, “NEC and MININEC Antenna Modeling Programs: A Guide to Further Information,” *QEX*, Mar/Apr. 1998
  - J.S. Belrose, VE2CV, “Modeling HF Antennas with MININEC – Guidelines and Tips from a Code User’s Notebook,” *ARRL Antenna Compendium*, Vol. 3, ARRL, 1992
  - R. Lewallen, W7EL, “MININEC: The Other Edge of The Sword,” *QST*, February 1991; correction May 1991
  - J.C. Logan and J.W. Rockway, *The New MININEC (Version 3): A Mini-Numerical Electromagnetic Code*, Tech. Doc. 938, ADA181682, Naval Ocean Systems Center, Sept. 1986
  - A.J. Julian, J.C. Logan, and J.W. Rockway, *MININEC: A Mini-Numerical Electromagnetics Code*, Tech. Doc. 516, ADA121535, Naval Ocean Systems Center, Sept. 1982
- **MMANA-GAL** <http://hamsoft.ca/pages/mmana-gal.php>
  - S. Nichols, G0KYA, *An Introduction to Antenna Modelling*, RSGB, 2014

# References

- **MBC (Multiradius Bridge Current)**

- R. Abou-Jaoude and E.K. Walton, "Numerical Modeling of On-Glass Conformal Automobile Antennas," *IEEE Trans. Antennas and Propagation*, June 1998
- M.A. Tilston and K.G. Balmain, "A Multiradius, Reciprocal Implementation of the Thin-Wire Moment Method," *IEEE Trans. Antennas and Propagation*, Oct. 1990
- M.A. Tilston and K.G. Balmain, "On the Suppression of Asymmetric Artifacts Arising in an Implementation of the Thin-Wire Method of Moments," *IEEE Trans. Antennas and Propagation*, Feb. 1990
- M.A. Tilston, *Thin-Wire Reciprocal Multiradius Implementation of the Electromagnetic Moment Method*, Ph.D. thesis, U. Toronto, 1989, download from [http://www.phoenixantennas.com/Mark\\_Tilston\\_PhD\\_Thesis.html](http://www.phoenixantennas.com/Mark_Tilston_PhD_Thesis.html)

# References

- **FEKO** <https://www.feko.info>
  - A.Z. Elsherbeni, P. Nayeri, and C.J. Reddy, *Antenna Analysis and Design using FEKO Electromagnetic Simulation Software*, SciTech/IET, 2014
  - U. Jakobus and G. Smith, “State of the Art Electromagnetic Modelling in FEKO,” *EuCAP*, Mar. 2012
  - U. Jakobus, “Review of Advanced Electromagnetic Modeling Techniques in the Computer Code FEKO based on the Method of Moments with Hybrid Extensions,” *ACES Newsletter*, July 2003
- **WIPL-D** <http://www.wipl-d.com>
  - B.M. Kolundzija and A.R. Djordjević, *Electromagnetic Modeling of Composite Metallic and Dielectric Structures*, Artech House, 2002, ISBN 9780890063606
  - C.A. Fernandes, C. Salema, and M. Silveirinha, “WIPL-D Compared With Theory and Experiment,” *17<sup>th</sup> ACES Conf.*, Mar. 2001
- **HOBBIES** <http://em-hobbies.com>
  - Y. Zhang, et al., *Higher Order Basis Based Integral Equation Solver (HOBBIES)*, Wiley, 2012, ISBN 9781118140659
  - D. García-Doñoro et al., “HOBBIES - A New Electromagnetic Simulator,” *IEEE Int. Symp. Antennas and Propagation*, July 2010

# References

## ■ Finite Difference Time Domain Method

- Remcom XFDTD <http://www.remcom.com>
- Faustus Scientific Corp MEFiSTo <http://www.faustcorp.com>
- A. Taflove, "A Perspective on the 40-Year History of FDTD Computational Electrodynamics," *Applied Computational Electromagnetics Society (ACES) Conference*, Mar. 2006
- C.W. Penney, R.J. Luebbers, "Evaluation of SAR in Human Tissue at 5-6 GHz," *IEEE Int. Symp. Antennas and Propagation*, July 3-8, 2005
- K.S. Kunz and R.J. Luebbers, *The Finite Difference Time Domain Method for Electromagnetics*, CRC Press, 1993
- K.S. Kunz, R.J. Luebbers, F. Hunsberger, "A Thin Dipole Antenna Demonstration of the Antenna Modeling Capabilities of the Finite Difference Time Domain Technique," *Applied Computational Electromagnetics Society (ACES) Journal*, Mar. 1990
- A. Taflove, "Application of the Finite-Difference Time-Domain Method to Sinusoidal Steady State Electromagnetic Penetration Problems," *IEEE Trans. Electromagnetic Compatibility*, Aug. 1980
- K.S. Yee, "Numerical Solution of Initial Boundary Value Problems Involving Maxwell's Equations in Isotropic Media," *IEEE Trans. Antennas and Propagation*, Mar. 1966

# References

## ■ Phantoms and Dielectric Properties of Biological Tissues

- A-K. Lee et al., “SAR Comparison of SAM Phantom and Anatomical Head Models for a Typical Bar-Type Phone Model,” *IEEE Trans. Electromagn. Compatibility*, Oct. 2015
- S.W.K. Wardhani et al., “Effect of Human Head Phantom Models on the Performance of Dipole Antenna at 5.8 GHz,” *14<sup>th</sup> Int. Conf. Quality in Research*, Aug. 2015
- A. Peyman, “Dielectric Properties of Tissues and Their applications; State of Knowledge,” *IEEE MTT-S Int. Microwave Workshop Series on RF and Wireless Technologies for Biomedical and Healthcare Applications*, London, Dec. 2014
- *IEEE Recommended Practice for Determining the Peak Spatial-Average Specific Absorption Rate (SAR) in the Human Head from Wireless Communication Devices: Measurement Techniques*, IEEE Standard 1528-2013, June 14, 2013
- A.R. Ruddle et al., “Variation of Computed In-veh. SAR with Number and Location of Occupants at Commonly Used Communications Frequencies,” *10<sup>th</sup> Int. Symp. Electromagnetic Compatibility (EMC Europe)*, Sept. 2011
- T. Nagaoka and S. Watanabe, “Voxel-Based Variable Posture Models of Human Anatomy,” *Proc. IEEE*, Dec. 2009
- K. Ito, “Numerical and Experimental Human Body Phantoms,” *IET Seminar on Antennas and Propagation for Body-Centric Wireless Communications*, Apr. 2007
- T. Nagaoka et al., “An anatomically realistic voxel model of the pregnant woman and numerical dosimetry for a whole-body exposure to RF electromagnetic fields,” *28<sup>th</sup> IEEE Int. Conf. Engineering in Medicine and Biology Society*, New York, Aug/Sept. 2006
- P.A. Mason et al., “Effects of Frequency, Permittivity, and Voxel Size on Predicted Specific Absorption Rate Values in Biological Tissue During Electromagnetic-Field Exposure,” *IEEE Trans. Microwave Theory and Techniques*, Nov. 2000

# Commercial CEM Software Industry

## ■ Recent consolidations

- 2008 ANSYS bought Ansoft for \$832M (HFSS)
- 2010 Mentor Graphics bought Zeland Software (IE3D and Fidelity)
- 2011 National Instruments bought Applied Wave Research for \$58M (Analyst, Axiem, EM Socket, Microwave Office)
- 2014 Keysight spun off from Agilent (ADS, EMPro)
- 2014 Altair bought EM Software and Systems (FEKO)
- 2015 ANSYS bought Delcross Technologies (Savant)
- 2016 Dassault Systèmes bought CST for €220M Euros (Studio Suite)

## ■ Others

- Cadence (Allegro Sigrity)
- COMSOL (Multiphysics)
- Faustus Scientific (MEFiSTo)
- IMST (Empire XCcel 3D)
- Mician ( $\mu$ Wave Wizard)
- MiG (WASP-NET)
- Remcom (XFdtd)
- Sonnet (Blink)
- Tech-X (VSim, Vorpai)
- WiPL-D

The CEM software business is evolving as fast as CEM software.



# Antenna Modeling Programs for Radio Amateurs

- **EZNEC** <http://www.eznec.com>
  - EZNEC v.6 Demo program Free (20 segments, also runs ARRL models)
  - EZNEC v.6 \$100 (500 segments)
  - EZNEC+ v.6 \$150 (2,000 segments)
  - EZNEC Pro/2 v.6 \$525 (45,000 segments)
  - EZNEC Pro/4 v.6 \$675 (sold only to NEC4 licensees)
- **4nec2** <http://www.qsl.net/4nec2>
  - Free, 11,000 segments, two optimizers, all NEC commands supported
- **MININEC** <http://www.w8io.com/mininec.htm> or <http://www.blackcatsystems.com/software>
  - Black Cat Systems offers MiniNEC Pro version 1.4.0, \$29
- **MMANA-GAL** <http://hamsoft.ca/pages/mmana-gal.php>
  - Free Basic version 8,192 segments. Pro version 32,000 segments, \$130
- **NEC4** <https://ipo.llnl.gov/technologies/nec>
  - Noncommercial user license \$300
- **FEKO Student Edition** <http://www.altairuniversity.com/feko-student-edition>
  - Free to students. Part of HyperWorks 2017 Student Edition
- **WiPL-D** <http://www.wipl-d.com>
  - Free “Microwave Lite” v6.0 (665 unknowns) and free 30-day trial of professional v13.0
- **HOBBIES** <http://em-hobbies.com>
  - Book includes software registration code, online price varies from \$125 to \$231 MSRP
- **CST Studio Suite Student Edition** <https://www.cst.com/academia/student-edition>
  - Free 3D basic version, 10,000 tet voxels, 9 example modeling files and tutorial videos
- **MEFiSTo** <http://www.faustcorp.com>
  - Free FDTD modeling code 2D basic version and free trial of 3D professional version
- **openEMS** <http://openems.de>
  - Free open-source FDTD modeling code that uses Matlab or Octave

# Accessory Software for EZNEC

---

- **AutoEZ 2.0.18 by Dan Maguire, AC6LA, <http://www.ac6la.com>**
  - Excel/Visual Basic program
    - Demo version, free (30 segment limit)
    - Regular version, \$79
  - Requires Excel and EZNEC installed on computer
  - Controls EZNEC to make multiple runs
    - It's a GUI for a GUI for NEC
  - Has optimizer – Nelder-Mead algorithm
  - Reads NEC, AO, and MMANA-GAL files
  - Doesn't work with EZNEC-ARRL or EZNEC Demo
  - Replaces MultiNEC, which is no longer available
  - Highly recommended for EZNEC users

# HOBBIES

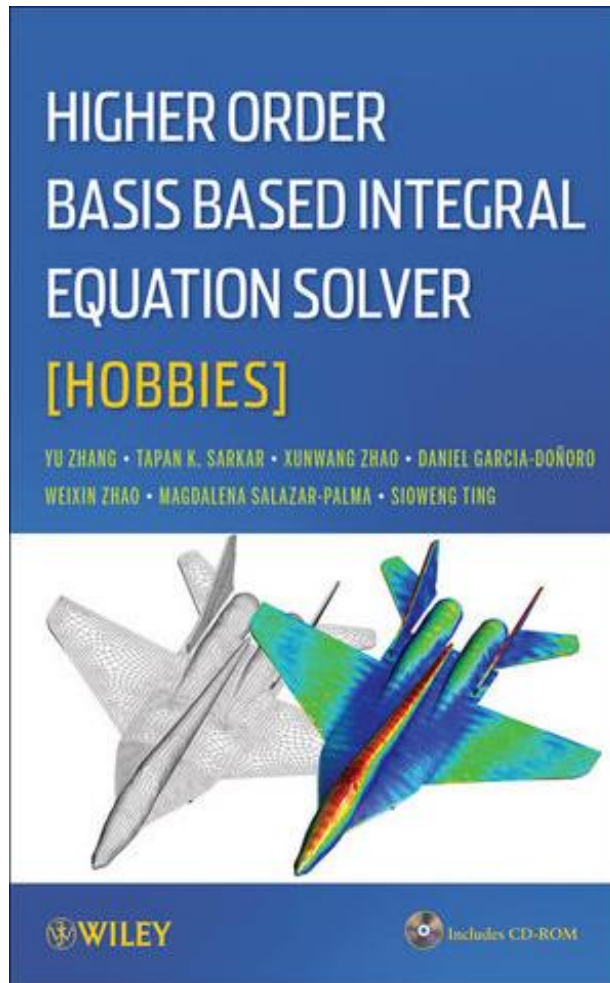

- <http://em-hobbies.com>
- Y. Zhang, et al., *Higher Order Basis Based Integral Equation Solver (HOBBIES)*, Wiley, 2012, ISBN 9781118140659
- **Make sure to buy a new copy with software license registration code intact and unused**

# Favorite Antenna Books

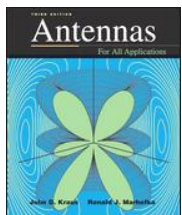
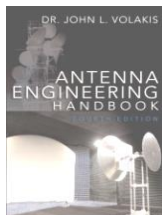
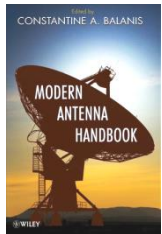
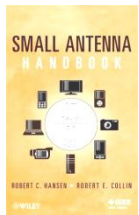
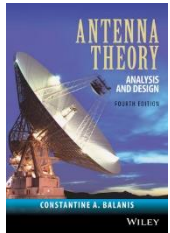

## ■ Books for antenna engineers and students

- C.A. Balanis, *Antenna Theory: Analysis and Design*, 4e, Wiley, 2016
- R.C. Hansen and R.E. Collin, *Small Antenna Handbook*, Wiley, 2011
- C.A. Balanis, ed., *Modern Antenna Handbook*, Wiley, 2008
- J.L. Volakis, ed., *Antenna Engineering Handbook*, 4e, McGraw-Hill, 2007
- J.D. Kraus and R.J. Marhefka, *Antennas*, 3e, McGraw-Hill, 2001

## ■ Antenna research papers

- IEEE AP-S Digital Archive, 2001-2009 (1 DVD), JD0307
- IEEE AP-S Digital Archive, 2001-2006 (1 DVD), JD0304
- IEEE AP-S Digital Archive, 2001-2003 (1 DVD), JD0301
- IEEE AP-S Digital Archive, 1952-2000 (2 DVDs), JD0351

## ■ ACES Journal Archives

- <http://www.aces-society.org/journal.php>

# Free Downloadable Books

- S.J. Orfanidis, *Electromagnetic Waves and Antennas*, Rutgers U., 2016
  - <http://www.ece.rutgers.edu/~orfanidi/ewa>
- D.M. Pozar, *Microwave Engineering*, 4e, Wiley, 2012
  - <http://exam-fever.com/ExamFever/rfmwetb.pdf>
- P-S. Kildal, *Foundations of Antenna Engineering*, 2015
  - <http://kildal.se/index.php/news-page/28-book>
- C.A. Balanis, *Antenna Theory: Analysis and Design*, 3e, Wiley, 2005
  - <https://archive.org/details/Antenna.Theory.Analysis.and.Design3rd.Edition>
- J. Layton, *Directional Broadcast Antennas: A Guide to Adjustment...*, TAB Books, 1974
  - <http://www.americanradiohistory.com/Archive.../Directional-Broadcast-Antennas-Leyton.pdf>
- A.D. Watt, *VLF Radio Engineering*, Pergamon Press, 1967
  - <http://www.introni.it/pdf/Watt%20-%20VLF%20Radio%20Engineering%2014.pdf>
- G.Z. Ayzenberg, *Shortwave Antennas*, revised edition, translated from Russian, 1962
  - <http://www.dtic.mil/docs/citations/AD0706545>
- S. Seely, *Radio Electronics*, McGraw-Hill, 1956
  - <https://archive.org/details/RadioElectronics>
- S.A. Schelkunoff and H.T. Friis, *Antennas: Theory and Practice*, Wiley, 1952
  - <https://archive.org/details/antennastheorypr00sche>
- E.A. Laport, *Radio Antenna Engineering*, McGraw-Hill, 1952
  - <http://snulbug.mtview.ca.us/books/RadioAntennaEngineering>
- K. Henney, *Radio Engineering Handbook*, McGraw-Hill, 1950
  - <https://archive.org/details/radioengineering00henn>
- F. Langford-Smith, *The Radiotron Designers Handbook*, Wireless Press, 1941
  - <https://archive.org/details/radiotrongdesigner00lang>
- K. Henney, *Principles of Radio*, Wiley, 1934
  - <https://archive.org/details/principlesofradi00henn>

# Favorite Antenna Books continued

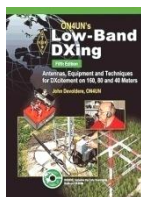
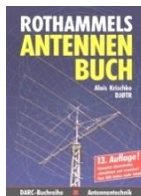
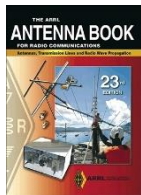

## Books for Radio Amateurs

- H.W. Silver, N0AX, ed., *ARRL Antenna Book*, 23e, American Radio Relay League, 2015
- A. Krischke, DJ0TR, ed., *Rothammel's Antennenbuch*, 13e, DARC Verlag, 2013
- J. Devoldere, ON4UN, *ON4UN's Low-Band Dxing*, 5e, American Radio Relay League, 2011
- I. Poole, G3YWX, ed., *Practical Wire Antennas 2*, Radio Society of Great Britain, 2005
- J. Sevick, W2FMI, *The Short Vertical Antenna and Ground Radial*, CQ Communications, 2003
- L. Moxon, G6XN, *HF Antennas for All Locations*, 2e, RSGB, 1983

## ARRL Antenna Compendium series – eight volumes

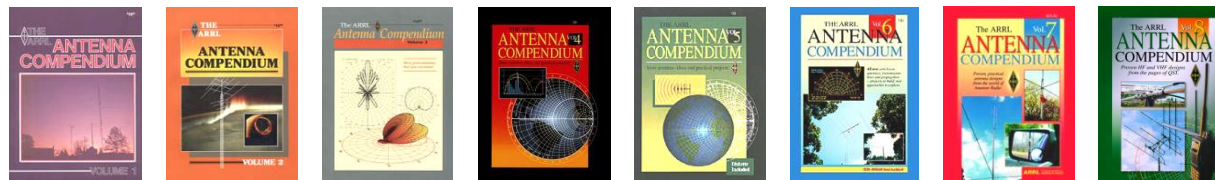

## ARRL Antenna Classics series – eight titles

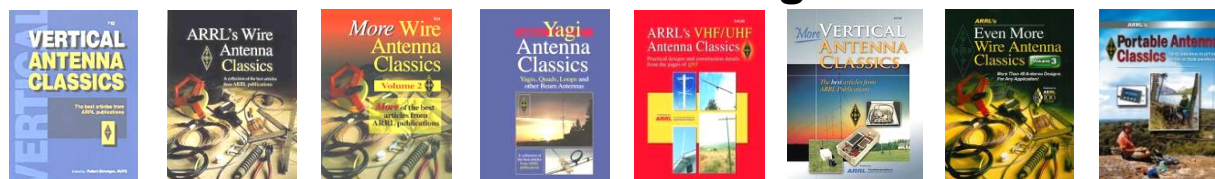

# Recent Antenna Books of Interest

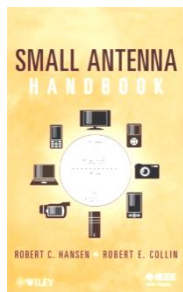

R.C. Hansen and R.E. Collin, *Small Antenna Handbook*, Wiley, 2011

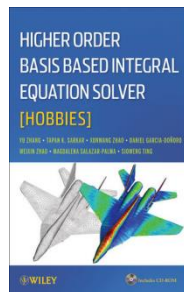

Y. Zhang et al., *Higher Order Basis Based Integral Equation Solver (HOBBIES)*, Wiley, 2012

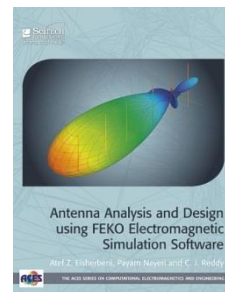

Elsherbeni, et al., *Antenna Analysis and Design using FEKO...*, SciTech / IET, 2014

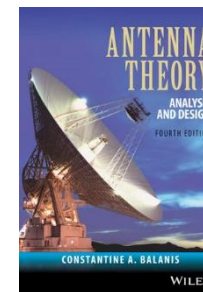

C.A. Balanis, *Antenna Theory: Analysis and Design, 4e*, Wiley, 2016

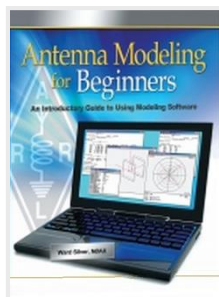

H.W. Silver, N0AX, *Antenna Modeling for Beginners*, ARRL, 2012

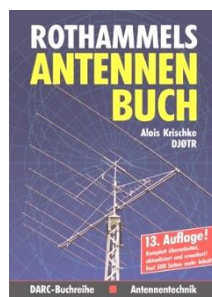

A. Krischke, DJ0TR, ed., *Rothammels Antennen Buch*, 13e, DARC, 2013

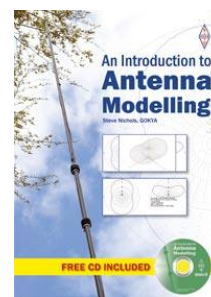

S. Nichols G0KYA, *An Introduction to Antenna Modelling*, RSGB, 2014

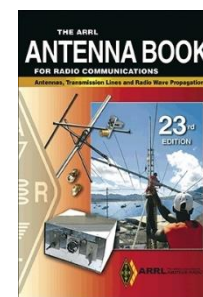

H.W. Silver, N0AX, ed., *ARRL Antenna Book*, 23e, ARRL, 2015

# Four Good History Reads

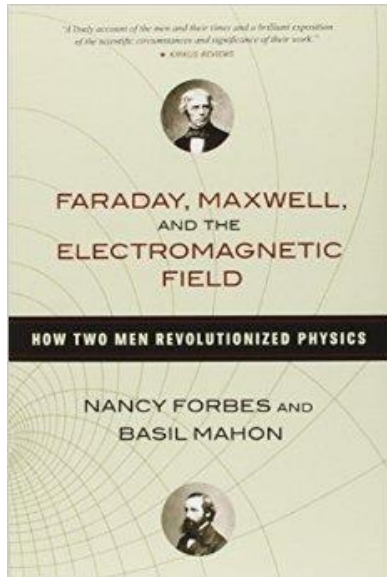

**Nancy Forbes and Basil Mahon, *Faraday, Maxwell, and the Electromagnetic Field*, Prometheus, 2014**

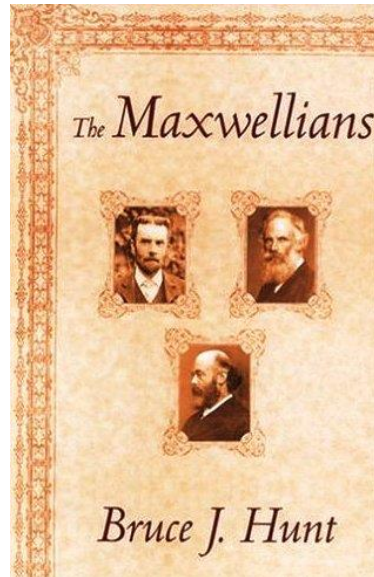

**Bruce J. Hunt, *The Maxwellians*, Cornell University Press, 1991**

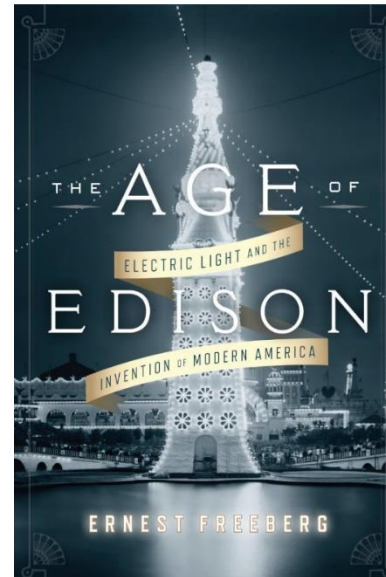

**Ernest Freeberg, *The Age of Edison*, Penguin Books, 2014**

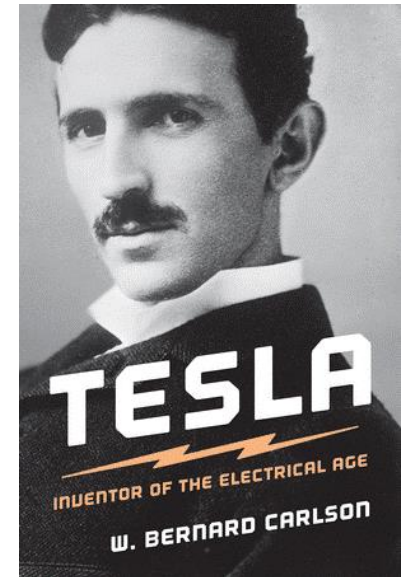

**W. Bernard Carlson, *Tesla: Inventor of the Electrical Age*, Princeton University Press, 2015**



---

# The End

This presentation will be archived at  
<http://www.fars.k6ya.org/others>