

---

# Antennas

**The Story from Physics to Computational Electromagnetics**

**Steve Stearns, K6OIK**

[stearns@ieee.org](mailto:stearns@ieee.org)

[k6oik@arrl.net](mailto:k6oik@arrl.net)

# Abstract

---

In this tutorial introduction to antennas, Steve Stearns, K6OIK, will talk about topics of interest, focusing on performance description but also touching on physics and history. He will review the historical timeline of events that led to modern computational electromagnetics. He will talk about the methods used by antenna engineers for antenna analysis and synthesis, including modern numerical modeling. Steve will tell the surprising tale of the mysterious multiplying factor  $K$  that defines dipole resonant length and reveal why the ARRL and RSGB graphs of  $K$  still disagree after 71 years.

Steve will tell which antenna modeling programs are free or inexpensive, the capabilities of different software to handle various shapes and materials, and which show results as graphs, 3D depictions, or movies of full-wave simulations. Also covered is meshing by 1D segments, 2D surface patches, and 3D voxels needed to compute wave propagation over irregular terrain or the fields inside inhomogeneous dielectric objects such as biological tissues.

This presentation will show the power of modern computational electromagnetics to solve practical problems in antenna engineering and Amateur Radio.

# Speaker's Biography



- **Stephen D. Stearns**
- **40 years experience in electronic systems**
  - Technical Fellow, Northrop Grumman Corp.
  - TRW, GTE Sylvania, Hughes Aircraft
  - Electromagnetic and signal processing systems for SIGINT sensor fusion, cochannel signal separation, precision geolocating of HF emitters by polarimetric vector-sensor array signal processing of ionospheric skywaves
  - Recent work: Antenna analysis, localized wave radiation, OAM Bessel-Vortex beams, circuit theory of non-Foster circuits for antennas and active metamaterials, reflectionless filters
- **FCC licenses**
  - Amateur Radio Extra Class
  - 1<sup>st</sup>-Class Radiotelephone
  - General Radio Operator License (GROL)
  - Ship Radar Endorsement
- **Education**
  - PhD Stanford – under Prof. T.M. Cover
  - MSEE USC – under Profs. H.H. Kuehl and C.L. Weber
  - BSEE CSUF – under Profs. J.E. Kemmerly and G.I. Cohn
- **10 patents**
- **More than 100 publications and presentations, both professional (IEEE) and hobbyist (Amateur Radio)**

# ARRL Pacificon Presentations by K6OIK

Archived at

<http://www.fars.k6ya.org>

1999	Mysteries of the Smith Chart	
2000	Jam-Resistant Repeater Technology	
2001	Mysteries of the Smith Chart	✓
2002	How-to-Make Better RFI Filters Using Stubs	
2003	Twin-Lead J-Pole Design	
2004	Antenna Impedance Models – Old and New	✓
2005	Novel and Strange Ideas in Antennas and Impedance Matching	
2006	Novel and Strange Ideas in Antennas and Impedance Matching II	✓
2007	New Results on Antenna Impedance Models and Matching	✓
2008	Antenna Modeling for Radio Amateurs	
2010	Facts About SWR, Reflected Power, and Power Transfer on Real Transmission Lines with Loss	✓
2011	Conjugate Match Myths	✓
2012	Transmission Line Filters Beyond Stubs and Traps	✓
2013	Bode, Chu, Fano, Wheeler – Antenna Q and Match Bandwidth	✓
2014	A Transmission Line Power Paradox and Its Resolution	✓
2015	Weird Waves: Exotic Electromagnetic Phenomena	✓
2015	The Joy of Matching: How to Design Multi-Band Match Networks	✓
2016	The Joy of Matching 2: Multi-Band and Reflectionless Match Networks	
2016-7	Antenna Modeling for Radio Amateurs – Revised and Expanded	✓
2017	VHF-UHF Propagation Planning for Amateur Radio Repeaters	

# Outline

---

- **History of electromagnetics and antenna analysis**
  - Linear cylindrical antennas
  - Dipole impedance, resonant length, and the multiplying factor  $K$
- **Computational electromagnetics (CEM)**
  - Method of Moments (MoM)
  - Antenna modeling programs for Radio Amateurs
  - Affordable or free software
- **Applications**
  - Fields inside and outside of coils
  - Field strength inside cars for 2-meter mobileers
  - Terrain modeling, the alternative to HFTA
  - Monopole on a spherical dielectric planet, with redwood trees, ground waves, and more
  - Baking a potato
  - Fields in biological tissues
- **References and resources**
  - Free or inexpensive software for antenna modeling
  - Antenna books

# 19<sup>th</sup> Century Scientists and Natural Philosophers of Electricity and Magnetism



**André-Marie Ampère**  
1775-1836



**Carl Friedrich Gauss**  
1777-1855



**Michael Faraday**  
1791-1867

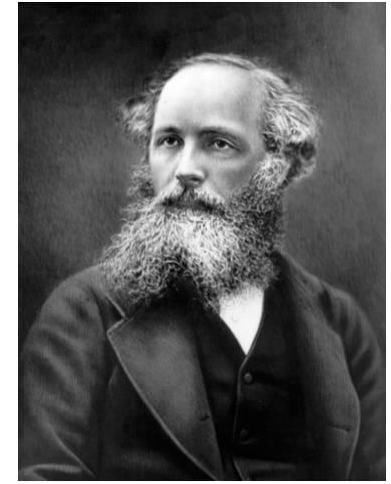

**James Clerk Maxwell**  
1831-1879

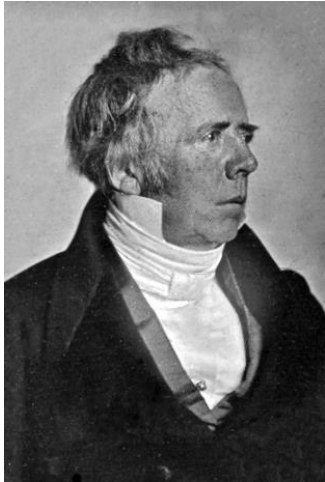

**Hans Christian Ørsted**  
1777-1851



**Georg Simon Ohm**  
1789-1854



**Joseph Henry**  
1797-1878



**Wilhelm Eduard Weber**  
1804-1891



# The Maxwellians

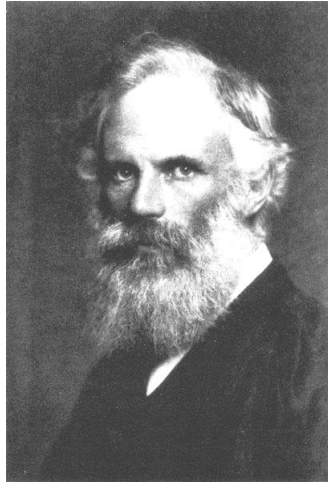

**George Francis FitzGerald**  
1851-1901

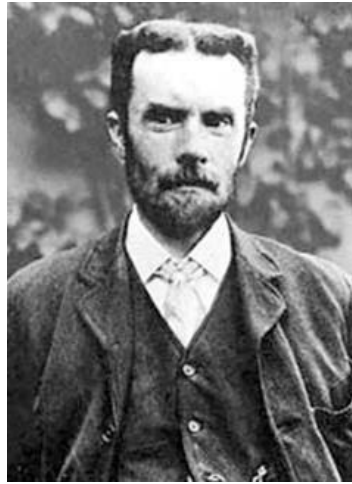

**Oliver Heaviside**  
1850-1925

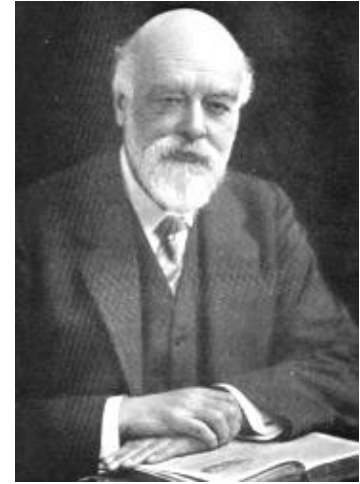

**Oliver Joseph Lodge**  
1851-1940



**Heinrich Rudolph Hertz**  
1857-1894

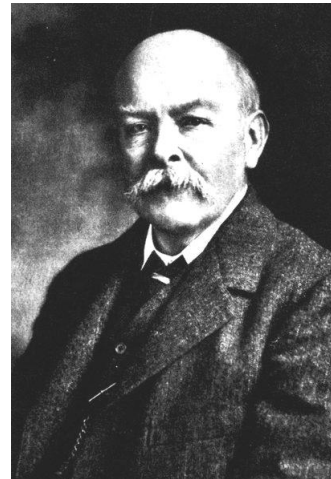

**John Henry Poynting**  
1851-1914

# Maxwell 1865 and the Equations in His 1873 Treatise

VIII. *A Dynamical Theory of the Electromagnetic Field.* By J. CLERK MAXWELL, F.R.S.

Received October 27,—Read December 8, 1864.

## PART I.—INTRODUCTORY.

(1) THE most obvious mechanical phenomenon in electrical and magnetical experiments is the mutual action by which bodies in certain states set each other in motion while still at a sensible distance from each other. The first step, therefore, in reducing these phenomena into scientific form, is to ascertain the magnitude and direction of the force acting between the bodies, and when it is found that this force depends in a certain way upon the relative position of the bodies and on their electric or magnetic condition, it seems at first sight natural to explain the facts by assuming the existence of something either at rest or in motion in each body, constituting its electric or magnetic state, and capable of acting at a distance according to mathematical laws.

In this way mathematical theories of statical electricity, of magnetism, of the mechanical action between conductors carrying currents, and of the induction of currents have been formed. In these theories the force acting between the two bodies is treated with reference only to the condition of the bodies and their relative position, and without any express consideration of the surrounding medium.

These theories assume, more or less explicitly, the existence of substances the particles of which have the property of acting on one another at a distance by attraction or repulsion. The most complete development of a theory of this kind is that of M. W. WEBER\*, who has made the same theory include electrostatic and electromagnetic phenomena.

In doing so, however, he has found it necessary to assume that the force between two electric particles depends on their relative velocity, as well as on their distance.

This theory, as developed by MM. W. WEBER and C. NEUMANN†, is exceedingly ingenious, and wonderfully comprehensive in its application to the phenomena of statical electricity, electromagnetic attractions, induction of currents and diamagnetic phenomena; and it comes to us with the more authority, as it has served to guide the speculations of one who has made so great an advance in the practical part of electric science, both by introducing a consistent system of units in electrical measurement, and by actually determining electrical quantities with an accuracy hitherto unknown.

\* *Electrodynamische Maassbestimmungen.* Leipzig Trans. vol. i. 1849, and TAYLOR'S Scientific Memoirs, vol. v. art. xiv.

† “Explicare tentatur quomodo fiat ut lucis planum polarizationis per vires electricas vel magneticas declinetur.”—Halis Saxonium, 1858.

$$a = \frac{dH}{dy} - \frac{dG}{dz} \quad (A) \quad \text{Art. 591}$$

$$b = \frac{dF}{dz} - \frac{dH}{dx}$$

$$c = \frac{dG}{dx} - \frac{dF}{dy}$$

$$P = c \frac{dy}{dt} - b \frac{dz}{dt} - \frac{dF}{dt} - \frac{d\psi}{dx}$$

$$Q = a \frac{dz}{dt} - c \frac{dx}{dt} - \frac{dG}{dt} - \frac{d\psi}{dy} \quad (B) \quad \text{Art. 598}$$

$$R = b \frac{dx}{dt} - a \frac{dy}{dt} - \frac{dH}{dt} - \frac{d\psi}{dz}$$

$$X = vc - wb$$

$$Y = wa - uc$$

$$Z = ub - va$$

$$a = \alpha + 4\pi A$$

$$b = \beta + 4\pi B$$

$$c = \gamma + 4\pi C$$

$$4\pi u = \frac{d\gamma}{dy} - \frac{d\beta}{dz}$$

$$4\pi v = \frac{d\alpha}{dz} - \frac{d\gamma}{dx}$$

$$4\pi w = \frac{d\beta}{dx} - \frac{d\alpha}{dy}$$

$$\mathfrak{D} = \frac{1}{4\pi} K \mathfrak{E}$$

$$\mathfrak{K} = C \mathfrak{E}$$

$$\mathfrak{E} = \mathfrak{K} + \mathfrak{D}$$

$$u = p + \frac{df}{dt}$$

$$v = q + \frac{dq}{dt}$$

$$w = r + \frac{dh}{dt}$$

$$\mathfrak{E} = (C + \frac{1}{4\pi} K \frac{d}{dt}) \mathfrak{E}$$

$$u = CP + \frac{1}{4\pi} K \frac{dP}{dt}$$

$$v = CQ + \frac{1}{4\pi} K \frac{dQ}{dt}$$

$$w = CR + \frac{1}{4\pi} K \frac{dR}{dt}$$

$$\rho = \frac{df}{dx} + \frac{dq}{dy} + \frac{dh}{dz}$$

$$\sigma = lf + mg + nh + l'f' + m'g' + n'h'$$

$$\mathfrak{B} = \mu \mathfrak{H}$$

(A) Art. 591

(B) Art. 598

(C) Art. 603

(D) Art. 605

(E) Art. 607

(F) Art. 608

(G) Art. 609

(H) Art. 610

(H\*)

(I) Art. 611

(I\*)

(J) Art. 612

(K) Art. 613

(L) Art. 614



# Heaviside's "Duplex" Equations for Maxwell's Theory

$$\nabla \times \mathbf{E} = -\mathbf{M} - \frac{\partial \mathbf{B}}{\partial t}$$

$$\nabla \times \mathbf{H} = \mathbf{J} + \frac{\partial \mathbf{D}}{\partial t}$$

$$\nabla \cdot \mathbf{D} = \rho_e$$

$$\nabla \cdot \mathbf{B} = \rho_m$$

$$\mathbf{D} = \varepsilon \mathbf{E}$$

$$\mathbf{J} = \sigma_e \mathbf{E}$$

$$\mathbf{B} = \mu \mathbf{H}$$

$$\mathbf{M} = \sigma_m \mathbf{H}$$

“And God said, Let there be light; and there was light.” *Genesis 1:3*

# Pre-History of Antennas

- 1785** Coulomb's Law is published – C-A. de Coulomb
- 1812** Poisson's Equation is published – S.D. Poisson
- 1813** Gauss's Divergence Theorem – C.F. Gauss or M.V. Ostrogradskii
- 1820** Discovery that electric current makes magnetic effects (field concept not yet articulated) – H.C. Øersted
- 1820** Discovery that electricity and magnetism are linked phenomena – André-Marie Ampère
- 1820** Biot-Savart Law discovered – J-B. Biot & P. Savart
- 1826** Ampère's Law is published – André-Marie Ampère
- 1831** Faraday's Law is published – M. Faraday
- 1842** Discovery of radiation – J. Henry
- 1856** "On Faraday's Lines of Force" – J.C. Maxwell
- 1861** "On Physical Lines of Force" – J.C. Maxwell
- 1865** "A Dynamical Theory of the Electromagnetic Field" – J.C. Maxwell
- 1873** *A Treatise on Electricity and Magnetism* – J.C. Maxwell
- 1879-94** The "Maxwellians" period – O. Heaviside, G.F. FitzGerald, O.J. Lodge

# Key Dates in Antennas

---

- 1875-87** Early radiation demonstrations: T.A. Edison 1875; A.E. Dolbear 1882; H. Hertz 1887
- 1889-06** Phased arrays – A. Artom, S.G. Brown, J.E. Murray
- 1895-01** Radio communication, fan dipole, polar plots – G. Marconi
- 1897** Biconical dipole, loading coil, tunable *LC* matching network, counterpoise, “impedance” – O.J. Lodge
- 1907** Goniometer, electrical steerable array, radio direction-finding – E. Bellini and A. Tosi
- 1907** Ground losses, ground waves – J. Zenneck
- 1909-26** Infinite half-space problem – A.N. Sommerfeld
- 1919** Trees as antennas – G.O. Squier
- 1923** Wave-tilt antenna – H.H. Beverage
- 1928** Endfire array with parasitic elements – H. Yagi and S. Uda
- 1934-37** Radials, ground currents and losses – G.H. Brown
- 1940** Albert Einstein popularizes the name “Maxwell’s Equations”
- 1947** Polyrod antenna – G.E. Mueller and W.L. Tyrell
- 1947-75** Small antennas – H. Wheeler

# Key Dates in Antennas continued

---

- 1948** Fundamental limit on antenna bandwidth – L.J. Chu
- 1950** *Antennas* – J.D. Kraus
- 1952** *Antennas: Theory and Practice* – S.A. Schelkunoff and H.T. Friis
- 1952** *Advanced Antenna Theory* – S.A. Schelkunoff
- 1956** *Theory of Linear Cylindrical Antennas* – R.W.P. King
- 1959** “Method of moments” – A.V. Kantorovich, G.P. Akilov
- 1961** *Antenna Engineering Handbook* – H. Jasik
- 1966** Finite difference method for fields problems – K.S. Yee
- 1967** Matrix methods for fields problems – R.F. Harrington
- 1974** Vivaldi antenna – L.R. Lewis, M. Fasset, M. Hunt
- 1976** Landstorfer antenna – F.M. Landstorfer
- 2003** Metamaterial radomes – R.W. Ziolkowski and A.D. Kipple
- 2006** *Electrically Small, Superdirective, and Superconducting Antennas* – R.C. Hansen
- 2016** *Antenna Theory*, 4<sup>th</sup> edition – C.A. Balanis

---

# Antenna Analysis

# **Sergei Alexander Schelkunoff, 1897-1992**

---



**Sergei Schelkunoff was a pioneer in antenna theory and electromagnetics at Bell Telephone Laboratories.**



# Ronold Wyeth Percival King, 1905-2006

---



**R.W.P. King, Cruft Laboratories, Harvard University, authority on linear cylindrical antennas, speaking at his 100<sup>th</sup> birthday party, Oct. 2005.**

# John Daniel Kraus, 1910-2004

---



**Professor John Kraus of the Ohio State University authored the famous book *Antennas* and taught a generation of antenna engineers.**

# Chen-To Tai, 1915-2004

---



**Professor Chen-To Tai of the University of Michigan was a famous researcher in electromagnetics and antenna theory.**

# Evolution of Tools and Methods for Antennas

- **Old style antenna analysis (1880 to 1970)**
  - Used mathematics, slide rules, nomographs, desk top calculators, lab measurements and field testing
  - Limited to simple geometries, and few antenna properties
    - Impedance
    - Far fields
- **Modern antenna analysis (1970 to present)**
  - Uses sophisticated computational electromagnetics (CEM) computer codes, aka antenna modeling software, and less dependence on measurement
  - Results validated by agreement among different algorithms
  - Allows for evaluation of complicated geometries, materials, and more antenna properties
    - Radiation pattern for each field or polarization
    - Polarization
    - Efficiency
    - Near fields
    - Specific absorption rate (SAR)
    - Mutual coupling between antennas in an array
    - Analytical gain/phase corrections for superresolution direction finding (DF) and MIMO communications
    - Scattering and radar cross-section for TEM and OAM illumination

# Methods of Exact Antenna Analysis for Cylindrical Antenna Current and Impedance

- **Pocklington's equation (1897)**
  - Integro-differential equation
    - Solved numerically in NEC
- **Induced EMF (IEMF) method (1922)**
  - L. Brillouin, *Radioélectricité*, April 1922
  - A.A. Pistolokors, *Proc. IRE*, March 1929
  - P.S. Carter, *Proc. IRE*, June 1932
  - S.A. Schelkunoff, papers and books 1941-1954
  - C-T. Tai, *J. Applied Physics*, July 1949
- **Hallén's equation (1938)**
  - Integral equation
  - Different solution methods used by
    - C.J. Bouwkamp at Philips Labs, Holland
    - R.W.P. King and students at Harvard U.
      - F.G. Blake
      - C.W. Harrison
      - D. Middleton
    - S.A. Schelkunoff and M.C. Gray at Bell Labs

# Induced EMF Method

- L. Brillouin, *Radioélectricité*, April 1922
- A.A. Pistorikors, *Proc. IRE*, March 1929
- P.S. Carter, *Proc. IRE*, June 1932
- C-T. Tai, *J. Applied Physics*, July 1949
- Assume sinusoidal current distribution
- Obtain pattern, radiation resistance and reactance
- Accurate for pattern and impedance of dipoles up to half-wavelength and verticals up to quarter-wavelength
- Inaccurate for impedance of dipoles longer than half-wavelength and verticals longer than quarter-wavelength
- Widely used for the design of AM broadcast towers
- Obsoleted by numerical methods

*Proceedings of the Institute of Radio Engineers*  
Volume 20, Number 6 June, 1932

## CIRCUIT RELATIONS IN RADIATING SYSTEMS AND APPLICATIONS TO ANTENNA PROBLEMS\*

BY

P. S. CARTER

(R.C.A. Communications, Inc., Rocky Point, L. I., N.Y.)

*Summary*—Expressions for the self and mutual impedances within a radiating system are developed by the use of the generalized reciprocity theorem. These expressions are given in terms of the distributions of the electric field intensities along the radiators.

A method for the determination of the field intensities is outlined. Formulas for the self and mutual impedances in several types of directional antennas are given.

Questions of practical interest in connection with arrays of half-wave dipoles, long parallel wires, and "V" type radiators are discussed. Different types of reflector systems are considered. Curves of the more important relations are shown.

The mathematical development is shown in an appendix.

IN THE design and the adjustment of antenna systems a knowledge of certain characteristics and relations is of great assistance.

We should know the theoretical directivity, that is, the ratio of the intensity of radiation in a desired direction to the mean intensity in all directions. The contribution of each radiating element to the total radiated power and the interactions between elements are important. In a good system the ratio of heat losses to radiated power must be low.

The intensity of radiation in the desired direction is relatively easy to obtain. To determine the total power we may, for mathematical purposes, imagine the system placed at the center of a very large sphere and compute the power flow through each element of area on the sphere. A summation gives the total. The average intensity is then this total divided by the number of units of solid angle contained in the sphere. The application of this method to long linear radiators and several types of directional antenna systems has been shown by the writer in detail.<sup>1</sup> Upon completion of this process we have a complete knowledge of the power flow in every direction in space but are left in entire ignorance as to the portions of this power contributed by the various antenna elements and as to the interactions between these elements.

To the communications engineer, who is quite familiar with the use of impedance operators in connection with ordinary circuit calcula-

\* Decimal classification: R116. Original manuscript received by the Institute, March 1, 1932. Presented before Twentieth Anniversary Convention of the Institute, Pittsburgh, Pa., April 9, 1932.

<sup>1</sup> Carter, Hansell, Lindenblad, "Development of directive transmitting antennas by R.C.A. Communications, Inc.," *Proc. I.R.E.*, vol. 19, pp. 1773-1842; October, (1931).

1004



# Dipole Impedance via the Induced EMF Method

## ■ Resistance

$$R_{in} = \frac{\eta}{4\pi \sin^2(kl)} \left\{ 2\gamma + 2\ln(2kl) - 2\text{Ci}(2kl) + \sin(2kl) [\text{Si}(4kl) - 2\text{Si}(2kl)] + \cos(2kl) [\text{Ci}(4kl) - 2\text{Ci}(2kl) + \gamma + \ln(kl)] \right\}$$

Terms vanish when  $l / \lambda$  is a half integer; impedance is independent of wire diameter for such lengths

## ■ Reactance

$$X_{in} = \frac{\eta}{4\pi \sin^2(kl)} \left\{ 2\text{Si}(2kl) - \cos(2kl) [\text{Si}(4kl) - 2\text{Si}(2kl)] + \sin(2kl) [\text{Ci}(4kl) - 2\text{Ci}(2kl) + \gamma + 2\ln(ka) - \ln(kl)] \right\}$$

## ■ Assumptions

- Circular cylindrical dipole
- In free space
- Made of PEC → no losses
- Length  $L = 2l \leq \lambda/2$
- Radius  $a$

Wire radius affects only reactance

# Halfwave Dipole – Impedance to 10 Digits

- Resistance

$$R_{in}\left(\frac{\pi}{2}, ka\right) = \frac{\eta}{4\pi} \left[ \gamma + \ln(2\pi) - \text{Ci}(2\pi) \right] = \frac{\eta}{4\pi} \sum_{n=1}^{\infty} \frac{(-1)^{n+1} (2\pi)^{2n}}{2n (2n)!} = 29.9792458 \times 2.437653393$$

$$R_{in} = 73.07901025 \text{ ohms}$$

- Reactance

$$X_{in}\left(\frac{\pi}{2}, ka\right) = \frac{\eta \text{Si}(2\pi)}{4\pi} = \frac{\eta}{4\pi} \sum_{n=1}^{\infty} \frac{(-1)^n (2\pi)^{2n+1}}{(2n+1)(2n+1)!} = 29.9792458 \times 1.418151576$$

$$X_{in} = 42.51511468 \text{ ohms}$$

- Is there practical value to such precise numbers?
- Yes, exact theoretical values are needed to validate the accuracy of numerical codes like NEC, FEKO, WIPL-D, and HOBBIES

# Resistance

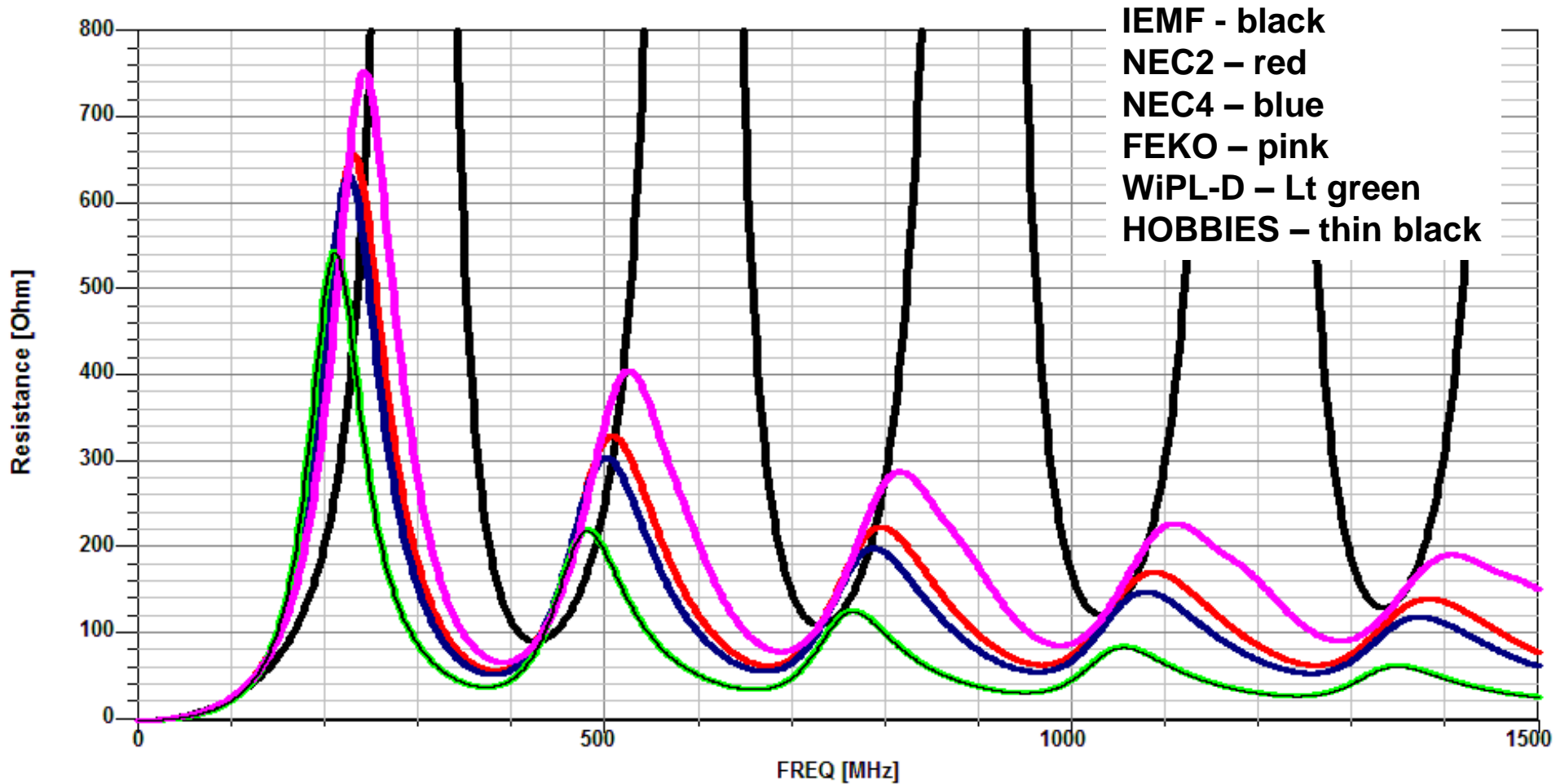

Resistances computed by different programs do not agree.

# Reactance

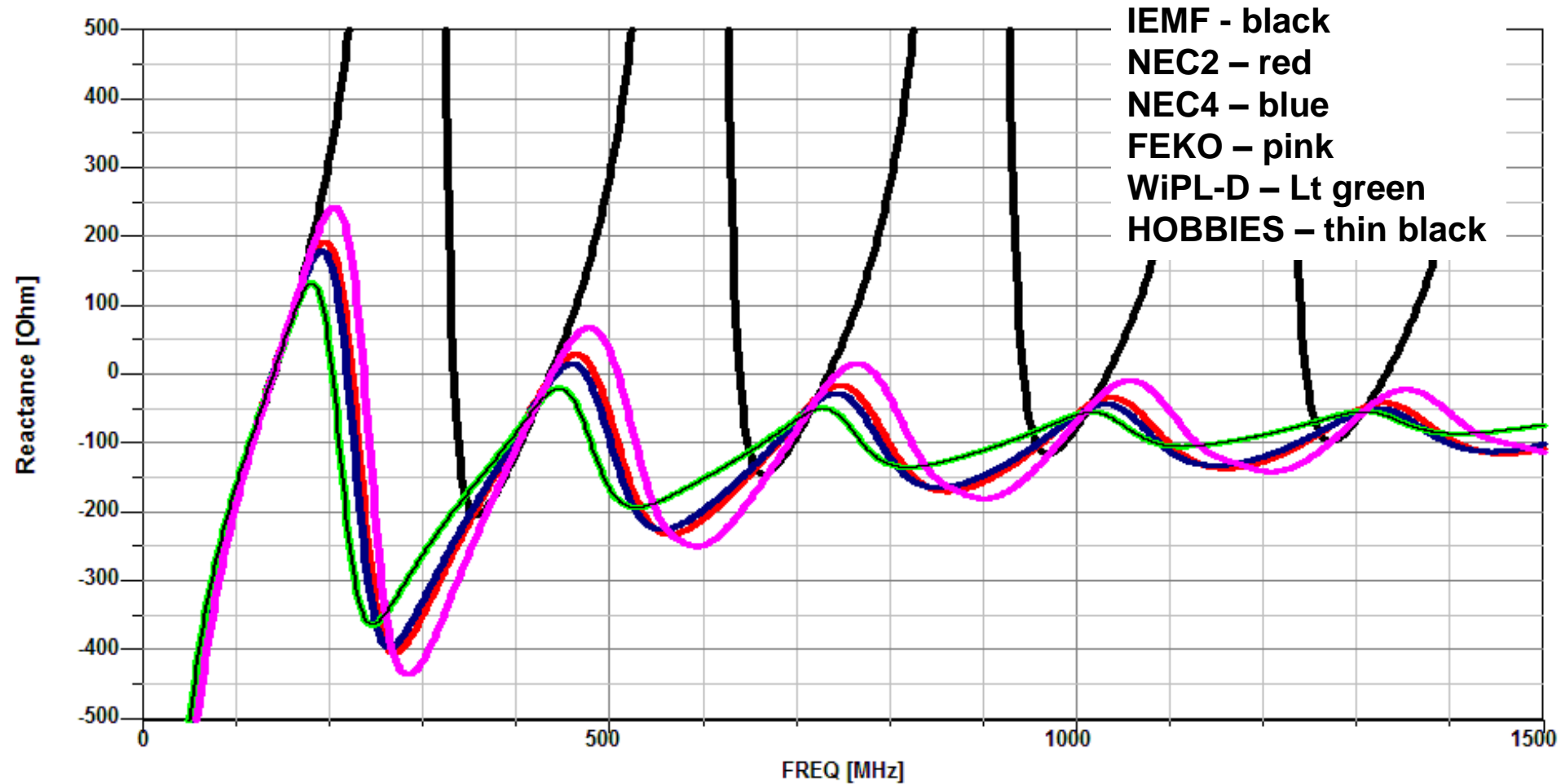

Reactances computed by different programs do not agree.

# Smith Chart – Yikes!

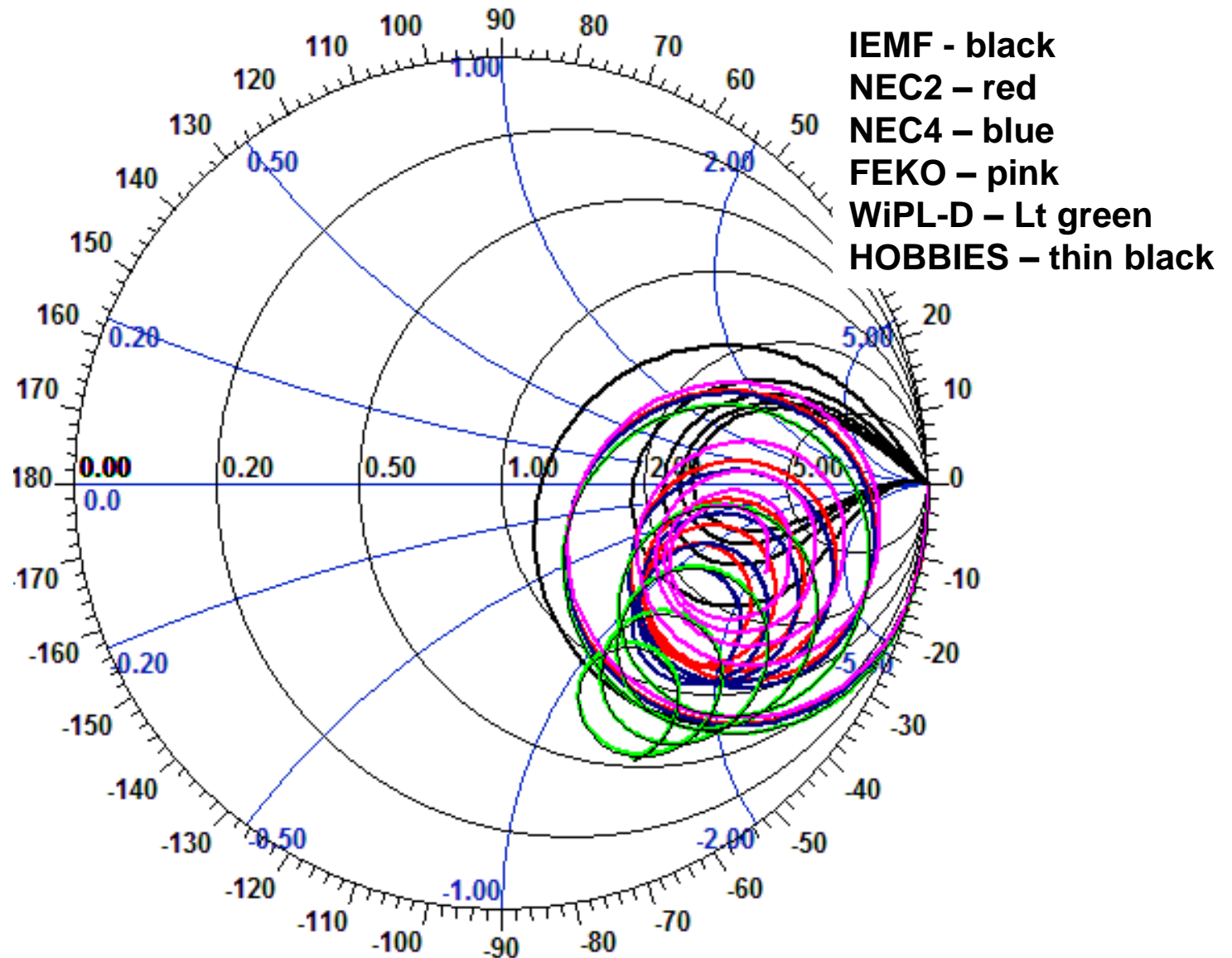

# Conductance

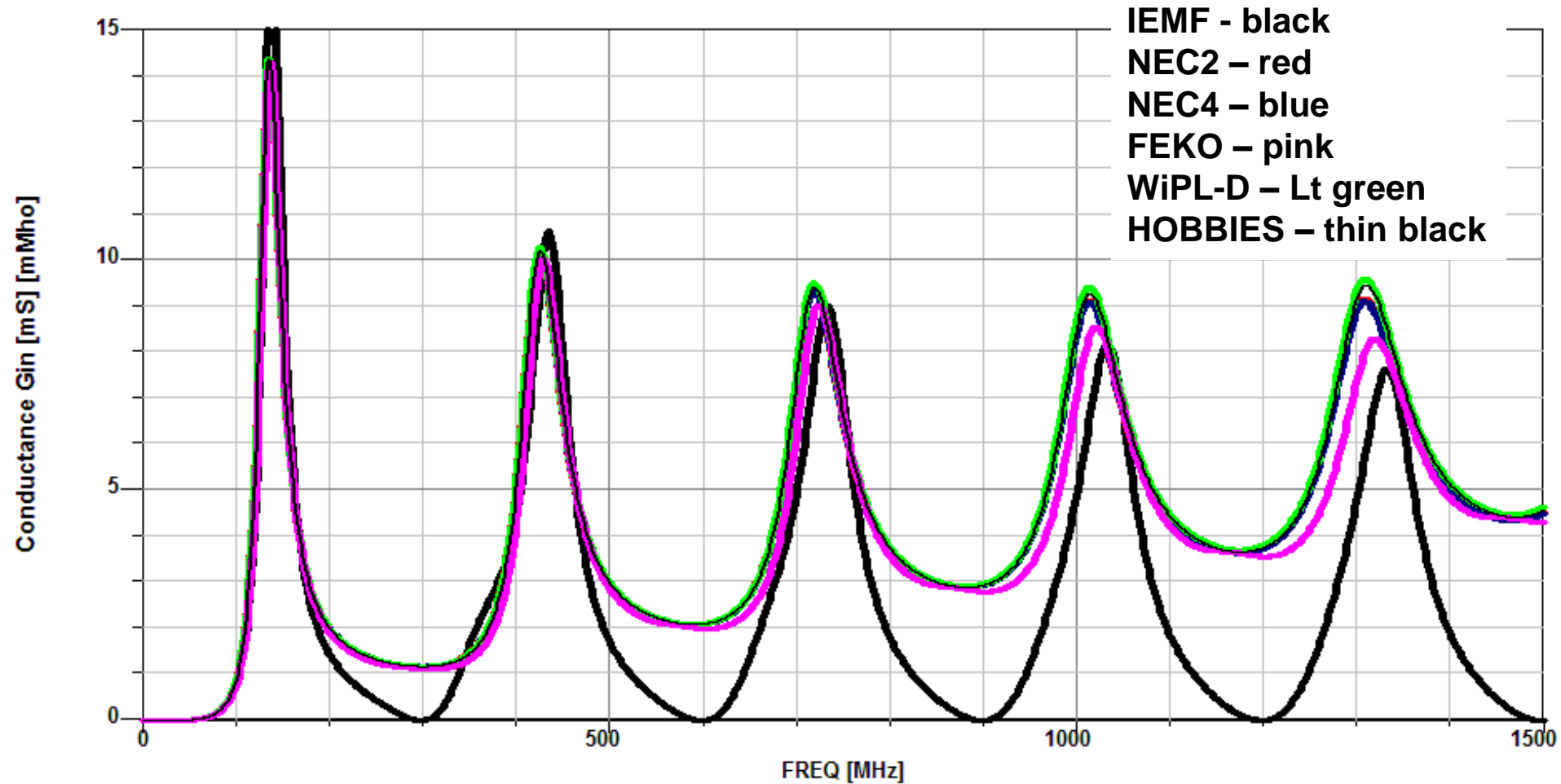

Conductances computed by different programs agree.



# Susceptance

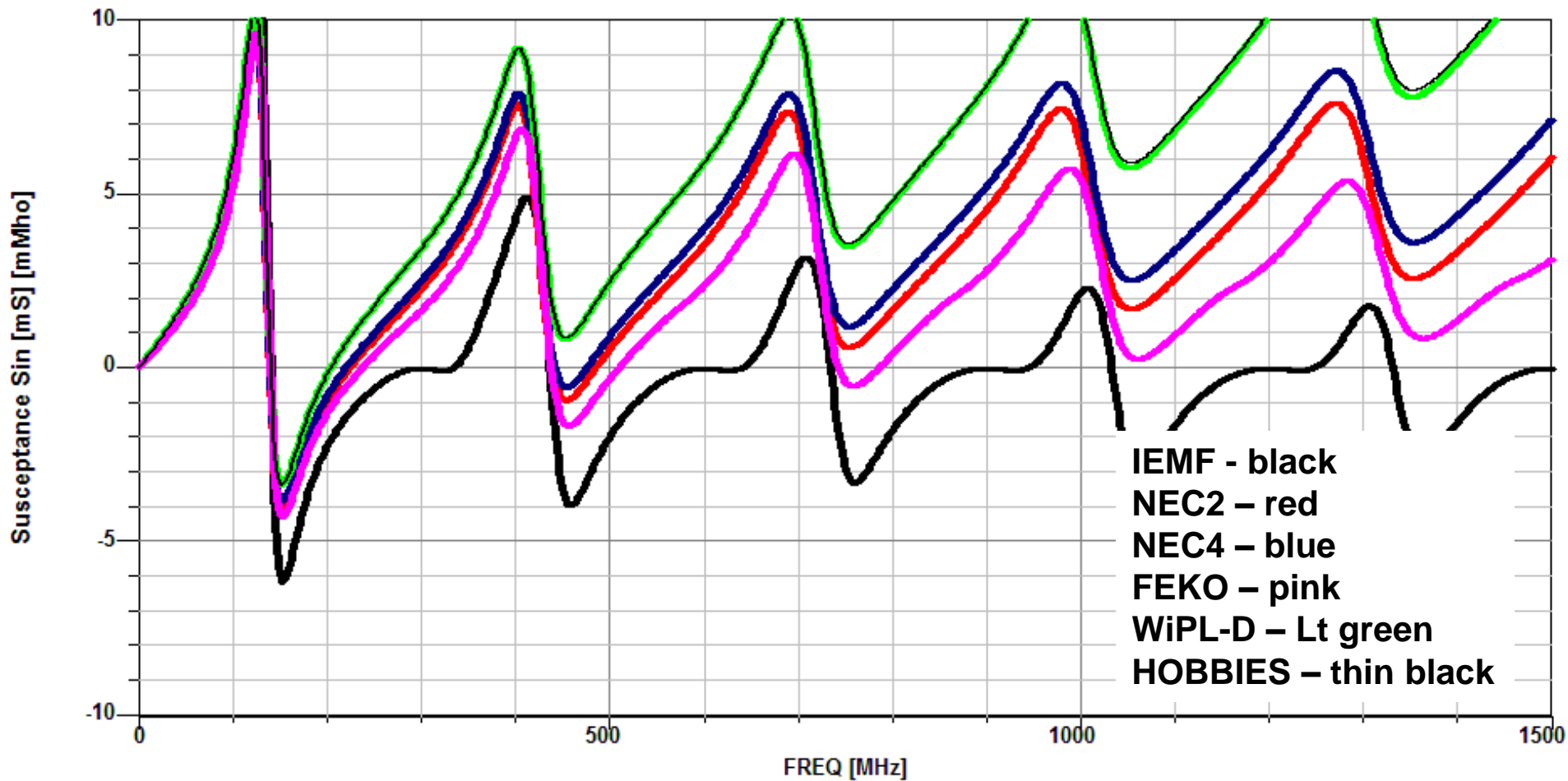

Susceptances computed by different programs differ only in linear tilt.

# Summary

---

- Differences among MoM methods can be attributed to different shunt capacitances inherent to their delta-gap sources
- FEKO's delta-gap source has the smallest shunt capacitance
- HOBBIES and WiPL-D's delta-gap sources have the most shunt capacitance
- NEC2 and NEC4's delta-gap sources have intermediate shunt capacitance
- Computational methods have difficulty determining resonant frequency to great accuracy

Numerical and measurement methods should be evaluated and validated on cases for which exact results are known.

---

# Dipole Resonance and Resonant Length

# Electric Field of a Halfwave Dipole

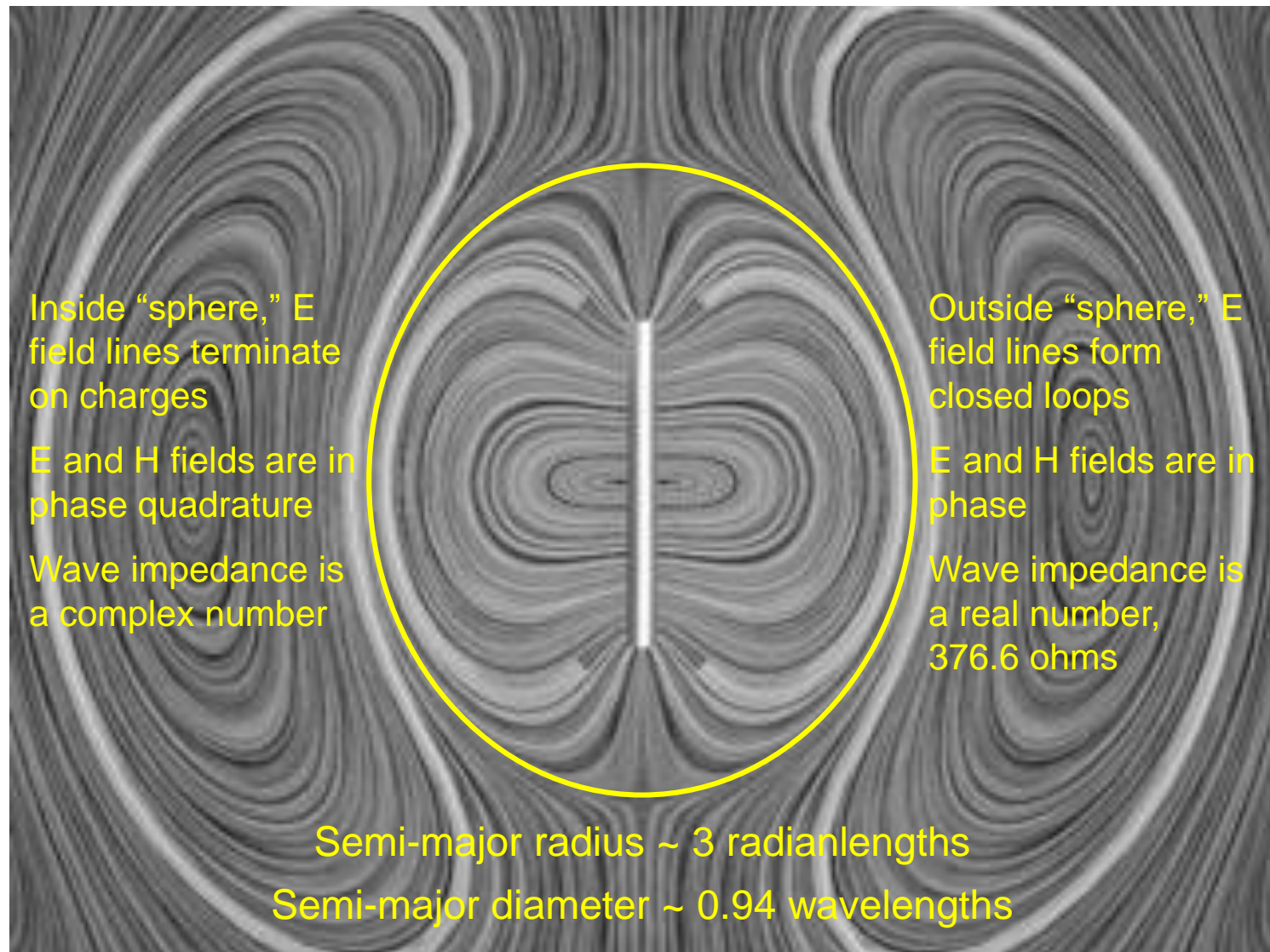

# Two Definitions of Resonance

- **Electric field energy equals magnetic field energy**

$$\iiint \left( \epsilon_0 |E|^2 - \mu_0 |H|^2 \right) dV = 0$$

- Some authors exclude radiation energy and consider only stored energy that is not associated with radiation, i.e. real power delivery to infinity

- **Feedpoint reactance is zero**

$$X(f) = 0$$

- This definition is standard but less fundamental
- A nonresonant antenna can be made resonant, and vice versa, by incorporating transmission line
- If an antenna's impedance curve lies entirely in the upper or lower half of the Smith chart and does not cross the horizontal  $X = 0$  midline, then it has no resonances

# Dipole Resonant Length

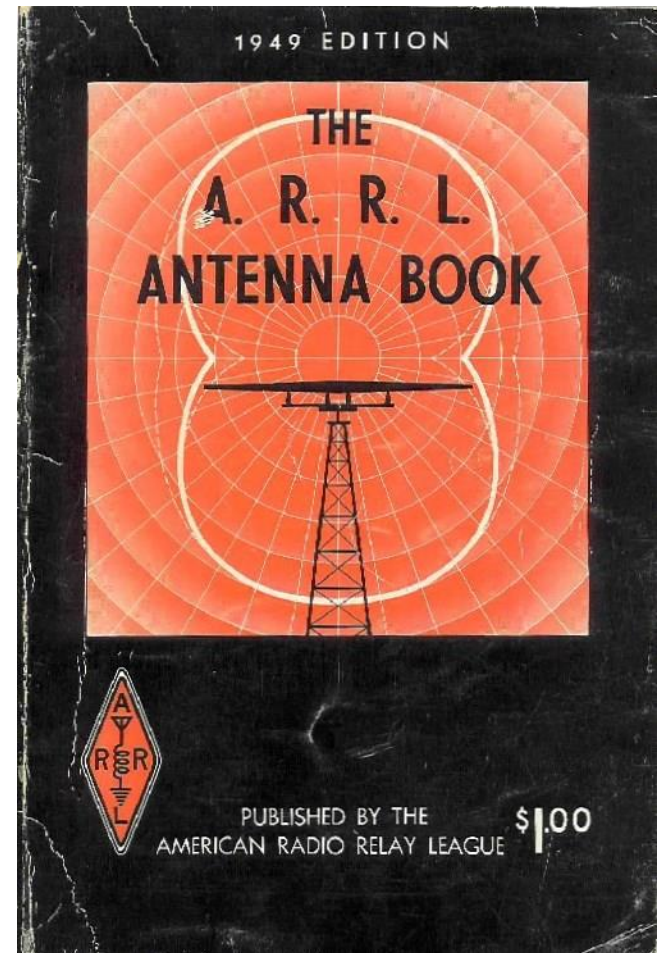
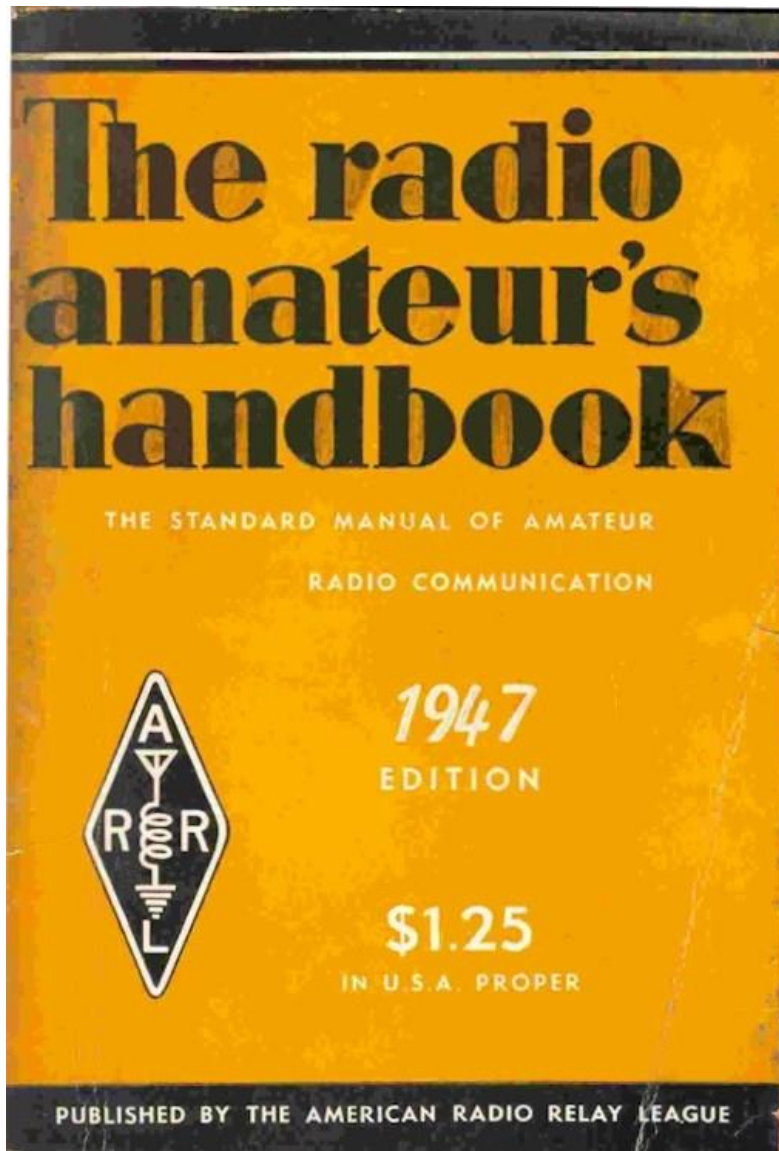

# The Multiplying Factor $K$

ARRL 1947-1997

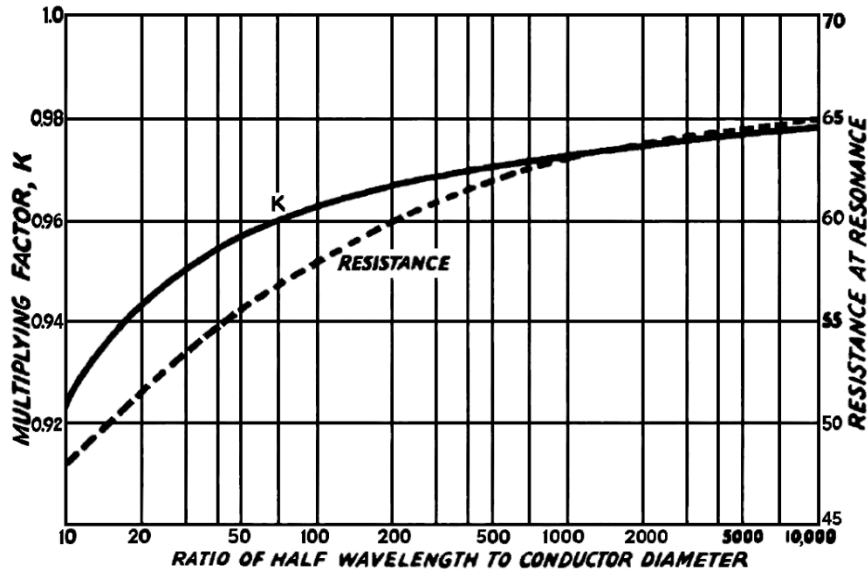

ARRL 1998-2018

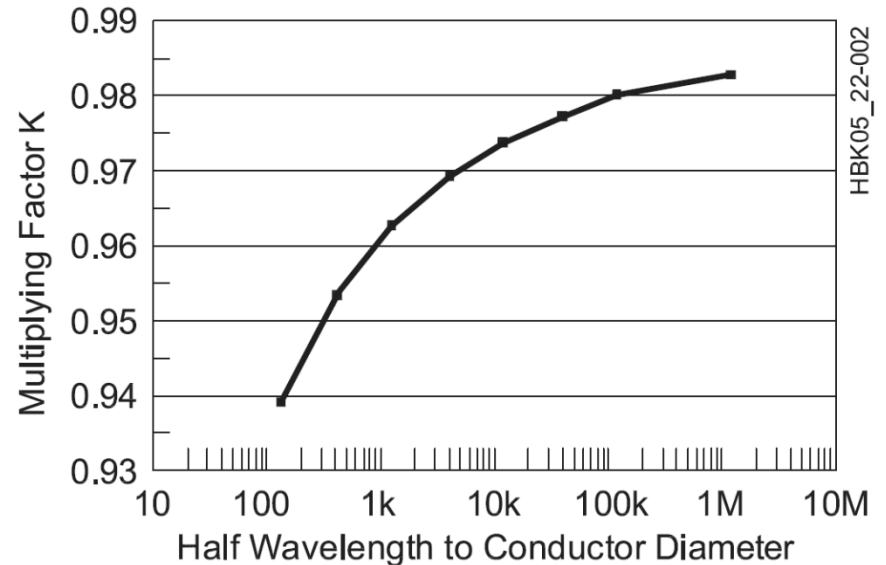

$$L_{res} = K \times \frac{\lambda}{2} = K \times \frac{491.786}{f_{MHz}} \text{ feet}$$

$K$  is not a velocity factor !



# The "K" Universe – Who is Right?

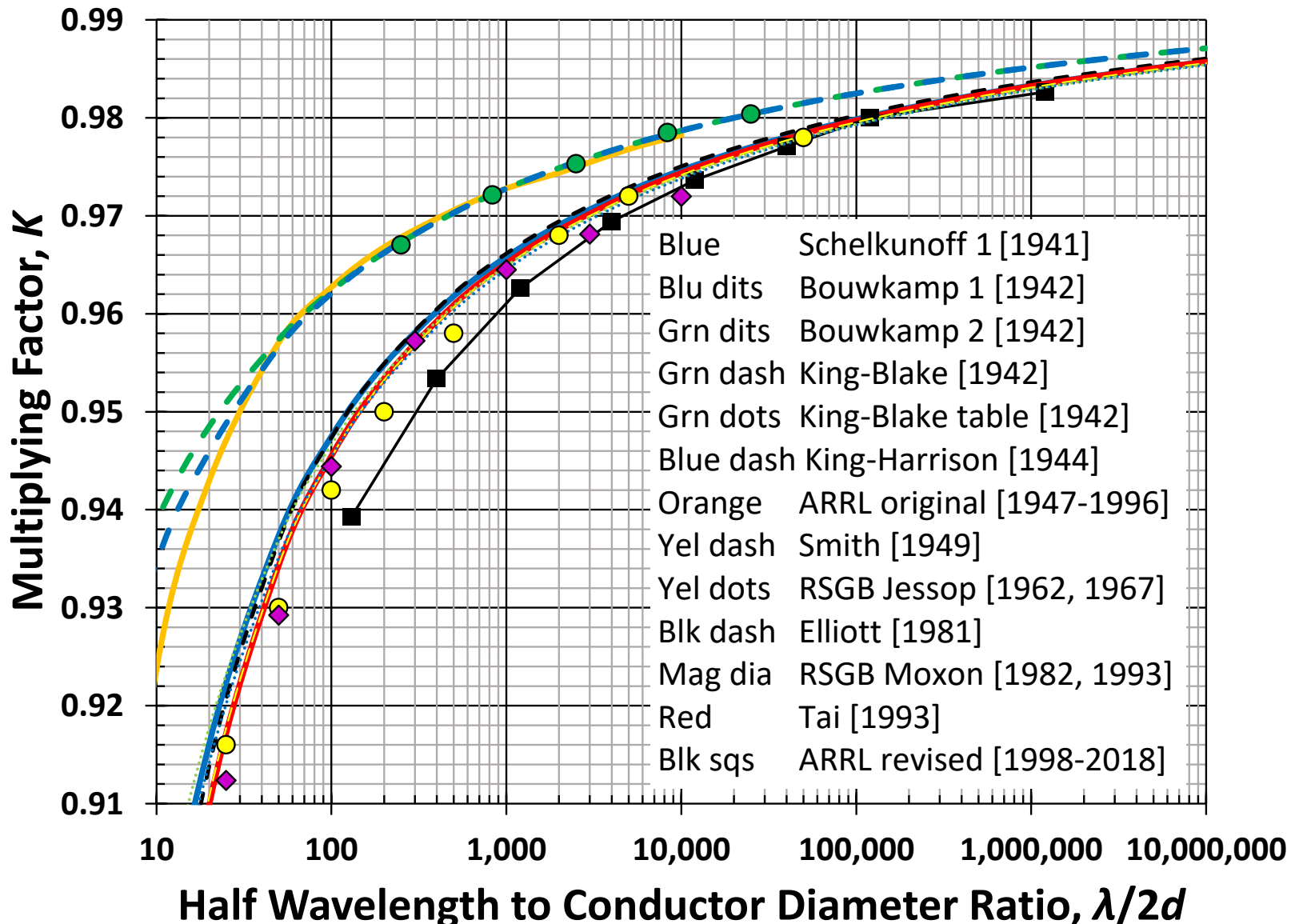



# The Real $K$

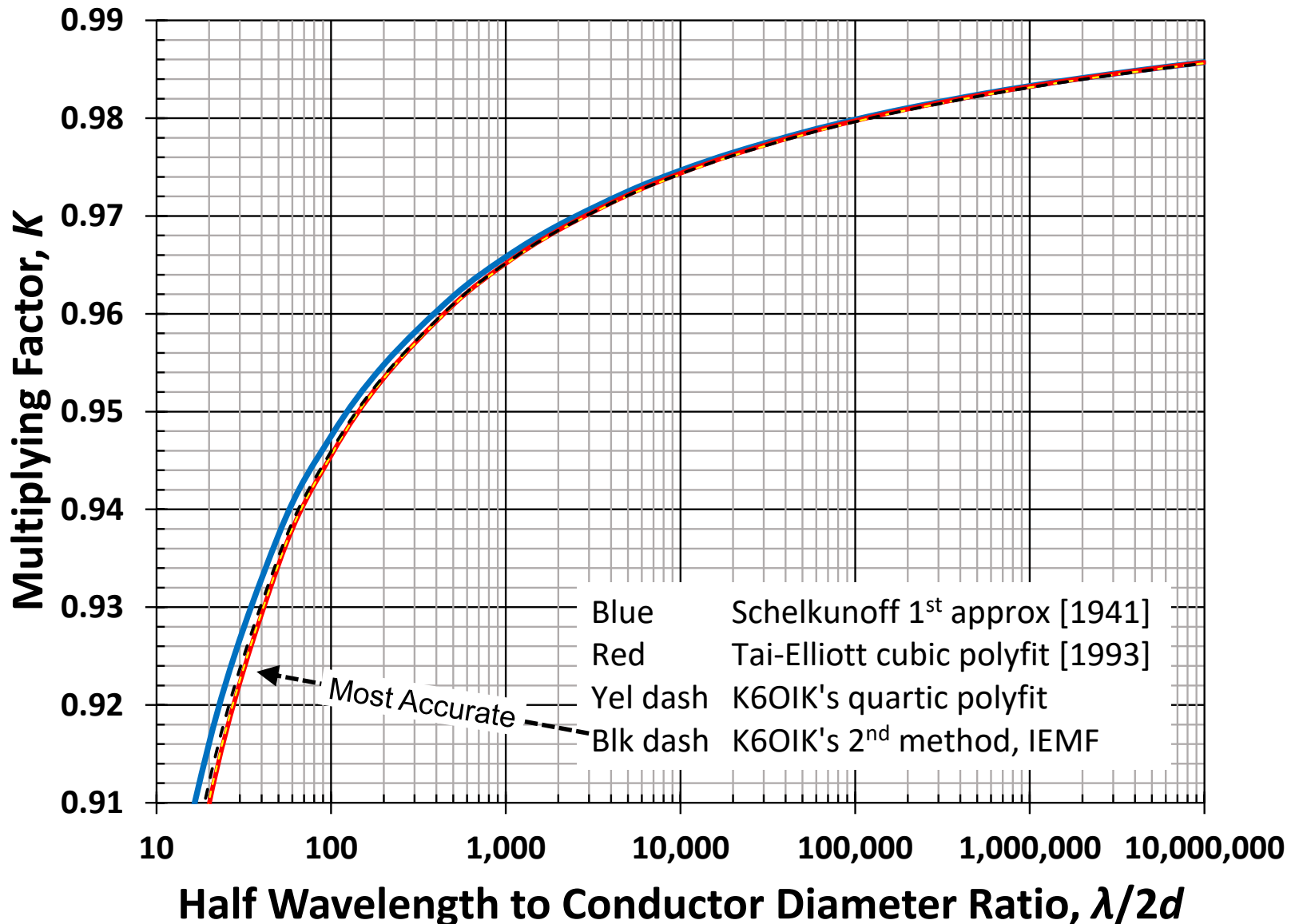

---

# Computational Electromagnetics

# The Universe of Antenna Modeling Methods

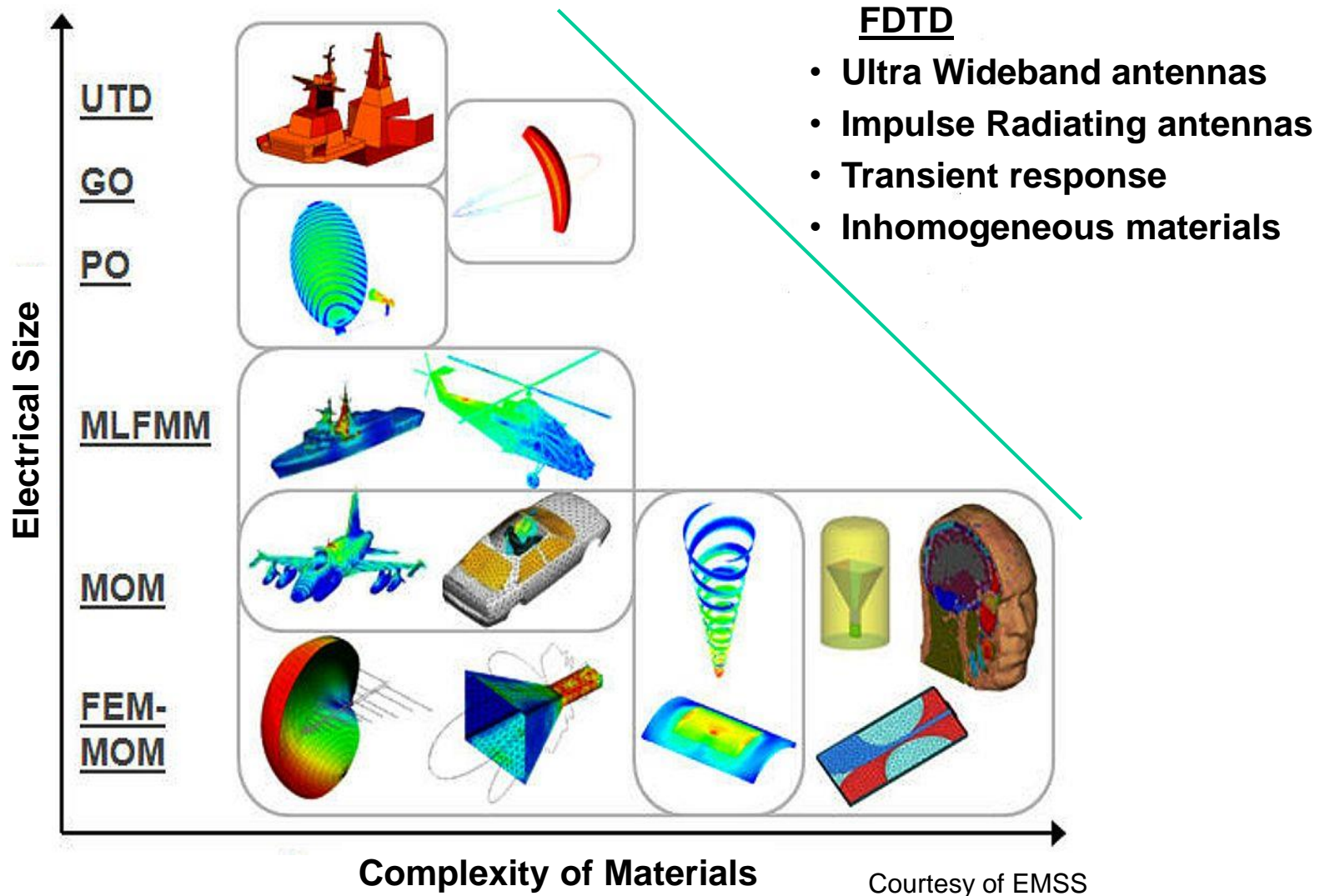

# Computational Electromagnetics

- **Method of moments (MoM)**

- A method for solving integro-differential equations such as Hallen's or Pocklington's equation at a frequency
- Earliest and longest legacy of software codes for antenna modeling
- BRACT, WIRA, AMP, NEC, NEC2, NEC3, NEC4, MININEC, ELNEC, EZNEC, winNECPlus, 4nec2, Mentor Graphics (Zeland) IE3D, Altair (EMSS) FEKO, WiPL-D, HOBBIES

- **Finite element method (FEM)**

- Best for design of small antennas of complex structure
- ANSYS (Ansoft) HFSS

- **Finite difference time-domain method (FDTD)**

- Pioneered by K.S. Yee 1966 and A. Taflove 1980
- Best for design of small antennas for wide bandwidth applications
- Dassault Systèmes (CST) Microwave Studio, Remcom XFDTD, Faustus MEFiSTo, openEMS

- **Geometric, physical, and uniform theories of diffraction**

- Best for electrically-large antennas and radiating structures
- ANSYS (Delcross) Savant

# Commercial CEM Software Industry

## ■ Recent consolidations

- 2008 ANSYS bought Ansoft for \$832M (HFSS)
- 2010 Mentor Graphics bought Zeland Software (IE3D and Fidelity)
- 2011 National Instruments bought Applied Wave Research for \$58M (Analyst, Axiem, EM Socket, Microwave Office)
- 2014 Keysight spun off from Agilent (ADS, EMPro)
- 2014 Altair bought EM Software and Systems (FEKO)
- 2015 ANSYS bought Delcross Technologies (Savant)
- 2016 Dassault Systèmes bought CST for €220M Euros (Studio Suite)

## ■ Others

- Cadence (Allegro Sigrity)
- COMSOL (Multiphysics)
- Faustus Scientific (MEFiSTo)
- IMST (Empire XCcel 3D)
- Mician ( $\mu$ Wave Wizard)
- MiG (WASP-NET)
- Remcom (XFdtd)
- Sonnet (Blink)
- Tech-X (VSim, Vorpai)
- WiPL-D

The CEM software business is evolving as fast as CEM software.

# The Method of Moments



**I.G. Bubnov**  
1872-1919



**Leonid Vitaliyevich Kantorovich**  
1912-1986



**Jack H. Richmond**  
1922-1990



**Boris Grigoryevich Galerkin**  
1871-1945

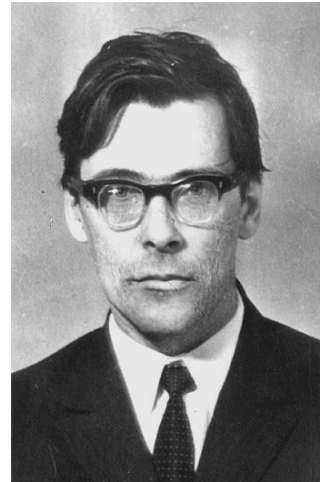

**Gleb Pavlovich Akilov**  
1924-1964



**Roger F. Harrington**  
1925-



# Meshing

- **1D segments**
- **2D patches**
  - Flat rectangles
  - Flat quadrilaterals
  - Flat triangles
  - Curved (bilinear) quadrilaterals
- **3D voxels**
  - Cubic or hexahedral
  - Tetrahedral
- **Manually specified meshing**
- **Automatic meshing**
- **Adaptive (smart) meshing**

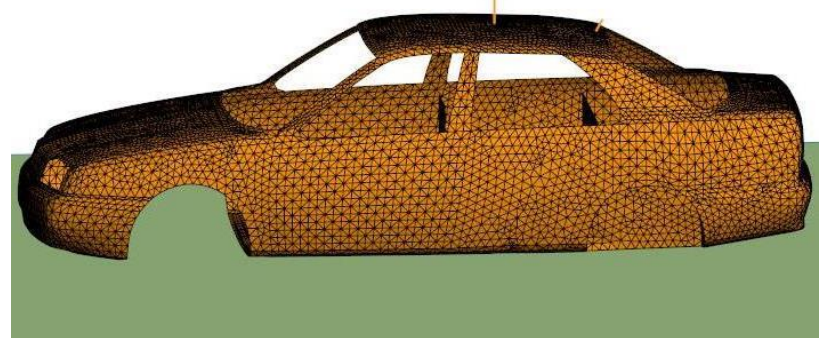
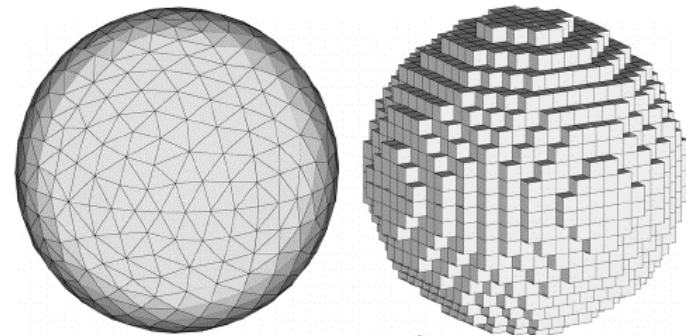
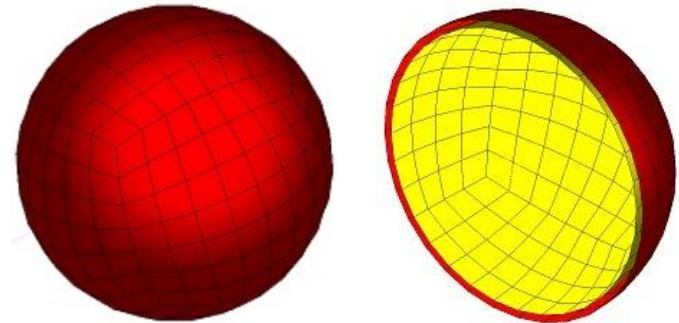

# Principal MoM Computer Codes

- **WIRA** – Developed late 1960s by M. Andreasen, F. Harris and R. Tanner at Technology for Communications International (TCI)
- **BRAC T & ANTBRAC T** – Developed late 1960s at MBAssociates, San Ramon, CA
- **AMP/AMP2** – Developed mid 1970s by G.J. Burke at MBAssociates, San Ramon
- **NEC (1979)** – Added more accurate current expansions; multiple wire junctions; thick wires
- **NEC-BSC (1980)** – Added Basic Scattering Code of J. Richmond at Ohio State
- **MiniNEC (1980)** – Developed by J. Rockway and J. Logan. Different algorithms from NEC. Basis of MMANA-GAL.
- **NEC2 (1981)** – Sommerfield-Norton ground interaction for wire structures above lossy ground; numerical Green's function allows modifying without repeating whole calculation
- **NEC3 (1985)** – Buried wires
- **NEC4 (1992)** – Improved accuracy for stepped-radius wires and electrically-small segments, end caps and insulated wires, catenary-shaped wires, improved error detection
- **Zeland IE3D (1992)** – Adaptive meshing, developed by J-X. Zheng, Zeland Software, Fremont, CA. Acquired by Mentor Graphics in 2010.
- **FEKO (ca 2000)** – Hybrid method developed by U. Jakobus at EMSS, Stellenbosch, South Africa. Acquired by Altair in 2014.
- **WiPL-D (ca 2000)** – Advanced MoM for wires, plates, and dielectrics based on work of A.R. Djordjevic, B.M. Kolundzija, University of Belgrade, Serbia
- **HOBBIES (2010)** – Similar to WiPL-D except has out-of-core solver. Developed by T.K. Sarkar, Syracuse University, New York, sponsored by U.S. DoD



# The History of NEC

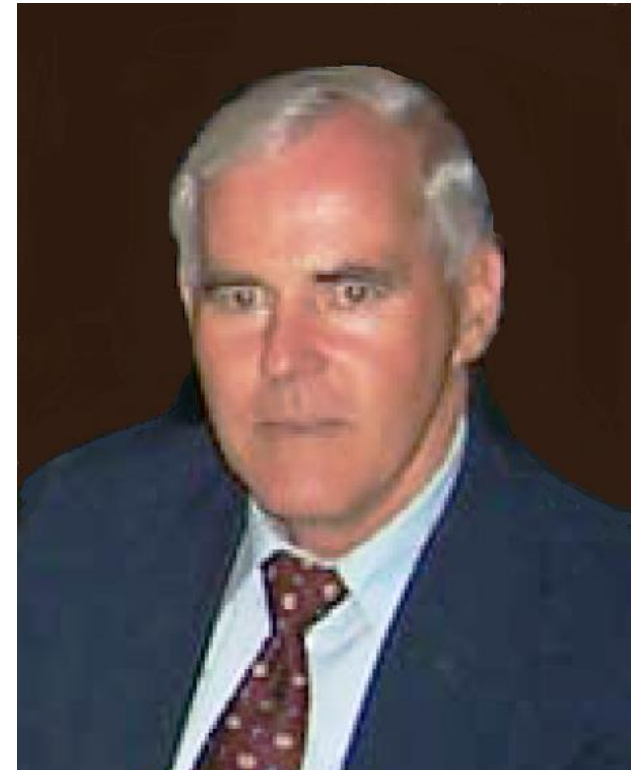
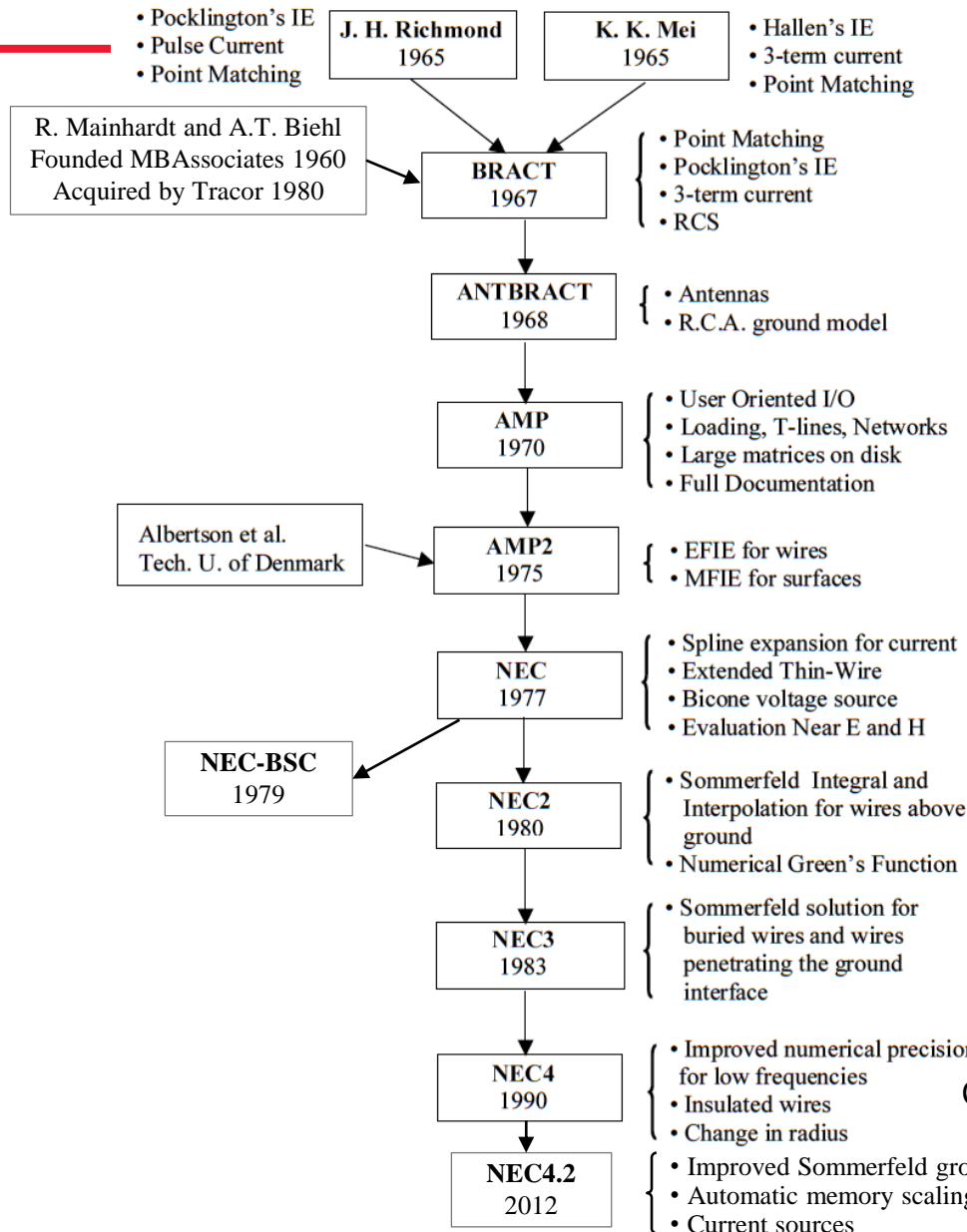

**Gerald J. Burke**

Courtesy of Applied Computational Electromagnetics Society

# A More Accurate "Thin-Wire" Code

- Multiradius Bridge Current (MBC) method
- Developed by M.A. Tilston 1983-89 at Univ. of Toronto
- Better accuracy than NEC4 when wires are very close to other wires or ground or join at acute angles, e.g. wire grid models of surfaces
- Used commercially by Phoenix Antenna Systems in Perth, Ontario, Canada
- Source code is in Fortran

1636

IEEE TRANSACTIONS ON ANTENNAS AND PROPAGATION, VOL. 38, NO. 10, OCTOBER 1990

## A Multiradius, Reciprocal Implementation of the Thin-Wire Moment Method

MARK A. TILSTON, MEMBER, IEEE, AND KEITH G. BALMAIN, FELLOW, IEEE

**Abstract**—An implementation of the moment method for electromagnetic analysis of multiradius thin-wire structures, including multiwire, multiradius junctions is presented. It is entitled the multiradius bridge-current (MBC) moment method. It is an extension of the authors' uniradius bridge-current reformulation of Richmond's uniradius thin-wire theory. The method features an exactly symmetric mutual impedance matrix ensuring reciprocity between sources, it is unconstrained with respect to both the length ratio and the radius ratio of adjoining segments provided that the wires are electrically thin, and it permits the self-consistent inclusion of coaxial-cable sections in the configuration under analysis. The method is validated through comparison with transmission-line theory for a two-wire line and a coaxial cable, and through comparison with measurements on a sleeve monopole antenna and a log-periodic dipole antenna. Finally, the MBC moment method program is shown to surpass the Numerical Electromagnetics Code (NEC) in terms of reciprocity and convergence for both an AM broadcast tower detuning stub problem and a bent two-wire transmission-line problem.

### I. INTRODUCTION

A WELL-KNOWN moment method computer program for the electromagnetic analysis of uniradius thin-wire structures is that of Richmond [1]. It has been shown by Butler and Wilton [2] that the particular method of expansion and testing, which they term "Pocklington piecewise-sinusoid Galerkin," is one of the best methods for obtaining rapid convergence in the solution. Although very useful, Richmond's program can display asymmetric artifacts when used to analyze certain symmetric structures, a problem that was observed by Vainberg and Balmain [3], explained and corrected approximately by Hilbert, Tilston, and Balmain [4], and finally more completely by the authors in their "bridge-current" formulation [5]. In the present work, the bridge-current formulation is extended to allow solution of the multiradius problem.

### II. DESCRIPTION OF BRIDGE-CURRENT MOMENT METHOD VERSIONS

#### A. Uniradius Bridge-Current Version

The uniradius bridge-current version forms the starting point for the multiradius bridge-current version. The unira-

dius version is described in detail in [5], and is described here briefly because it is necessary in order to explain the multiradius version.

The wire structure to be modeled consists of straight wire segments all of the same radius, and usually shorter than a quarter-wavelength. Conceptually, a current expansion function is a tubular dipolar current spanning the surface of two adjoining wire segments that are not necessarily collinear. Each expansion function has a corresponding identical tubular testing function, in a coincident location. The current on each segment is axially directed, sinusoidally distributed, continuous at the segment junction, and zero at the other end of each segment. The total current at the junction is unity. The mutual impedance between a tubular expansion dipole and a tubular testing dipole is composed of four tubular-monopole-to-tubular-monopole mutual impedances.

The mutual impedance between a tubular expansion monopole and a tubular testing monopole is approximated by the mutual impedance between two filamentary monopoles that are placed on their respective segment axes unless the axes intersect or coincide. If the axes coincide, the expansion monopole is offset by a wire radius in a direction orthogonal to the coincident axes. If the two axes intersect, the expansion monopole is offset by a wire radius in a direction orthogonal to the plane containing both axes.

Now consider one testing monopole and two expansion monopoles that form an expansion dipole. With certain geometries, the filamentary expansion monopoles may be offset from their segment axes in different directions, thus forming a dipole that is broken at its vertex. This would occur, for example, if the segment axis of one, and only one, of the two expansion monopoles was coplanar with (but not parallel to) that of the testing monopole. In such a case, the break is bridged by a straight, uniformly distributed "bridge current." With this geometry, the bridge current is orthogonal to the testing monopole. Because of this orthogonality, and because of its uniform current distribution, the bridge current does not contribute to the following symmetric integral form for the mutual impedance  $Z_{ab}$  between a filamentary testing monopole  $a$  and a bridged filamentary expansion dipole  $b$  [5]:

$$Z_{ab} = j\omega \iint \left[ \frac{\mu}{4\pi} \mathbf{J}_a(\mathbf{r}) \cdot \mathbf{J}_b(\mathbf{r}') \right] e^{-\gamma R} + \frac{1}{4\pi\epsilon} \rho_a(\mathbf{r}) \rho_b(\mathbf{r}') \left] \frac{e^{-\gamma R}}{R} dV' dV \quad (1a)$$

where

$$R = |\mathbf{r} - \mathbf{r}'|, \quad (1b)$$

Manuscript received May 26, 1989; revised February 9, 1990. This work was supported by Bell Canada, by the Natural Sciences and Engineering Research Council, and by The Ontario Information Technology Research Centre.

M. A. Tilston was with the Department of Electrical Engineering, University of Toronto, Toronto, ON, Canada. He is now with M. A. Tilston Engineering, 90 Lawrence Avenue East, Toronto, ON, Canada M4N 1S6.

K. G. Balmain is with the Department of Electrical Engineering, University of Toronto, Toronto, ON, Canada M5S 1A4.

IEEE Log Number 9037639.

0018-926X/90/1000-1636\$01.00 © 1990 IEEE

---

# **Applications**

**Fields Inside and Outside of Coils**

**Field Strength Inside Cars for 2-meter Mobileers**

**Terrain Modeling, the Alternative to HFTA**

**Monopole on a Spherical Dielectric Planet**

**Baking a Potato**

**Fields in Biological Tissues**

---

# **Fields Inside and Outside of Coils**

**HOBBIES**

# Rudy Severns N6LF's Big Coil

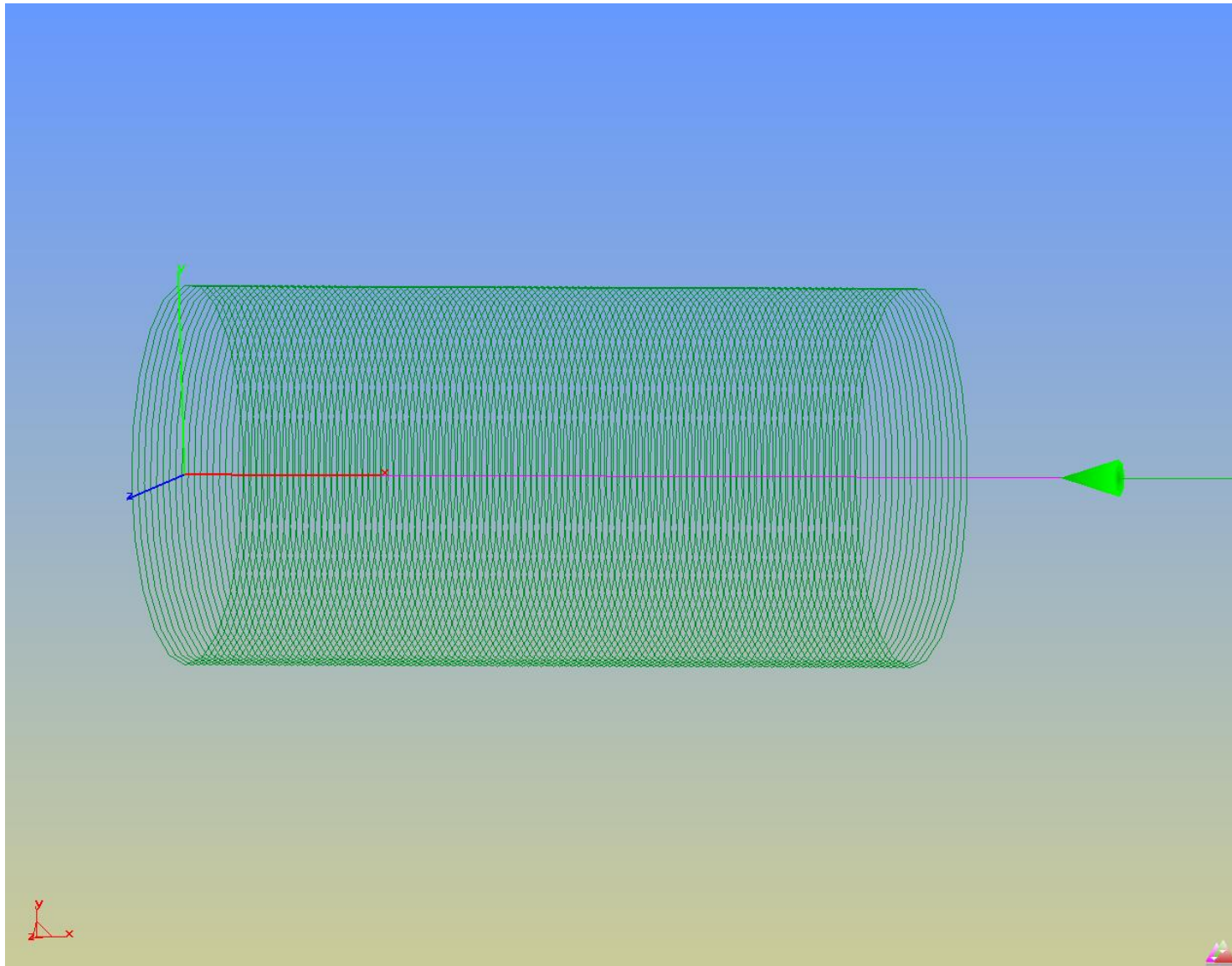

# K6OIK's Model of Rudy Severns N6LF's Big Coil

- Coil length – 20 inches (0.508 m)
- Coil diameter – 10 inches (radius 0.127 m to wire center)
- Wire gauge - #10 AWG (radius 1.29413 mm)
- Helix number of turns – 117
- Coil material – copper
- Conductivity – 59.6 MS/m
- Coil environment – free space
- E&M software – HOBBIES (similar to WiPL-D)
- Method – Method of Moments (MoM)
- Mode – Scattering
- Excitation method – TEM linear-polarized plane wave incident from coil end, i.e. propagating along coil axial direction
- Output – near fields on 81 x 61 grid in plane through coil axis
- Computation time – 45 seconds per frequency

# 1,718 kHz – Transverse Vertical H Component – Signed

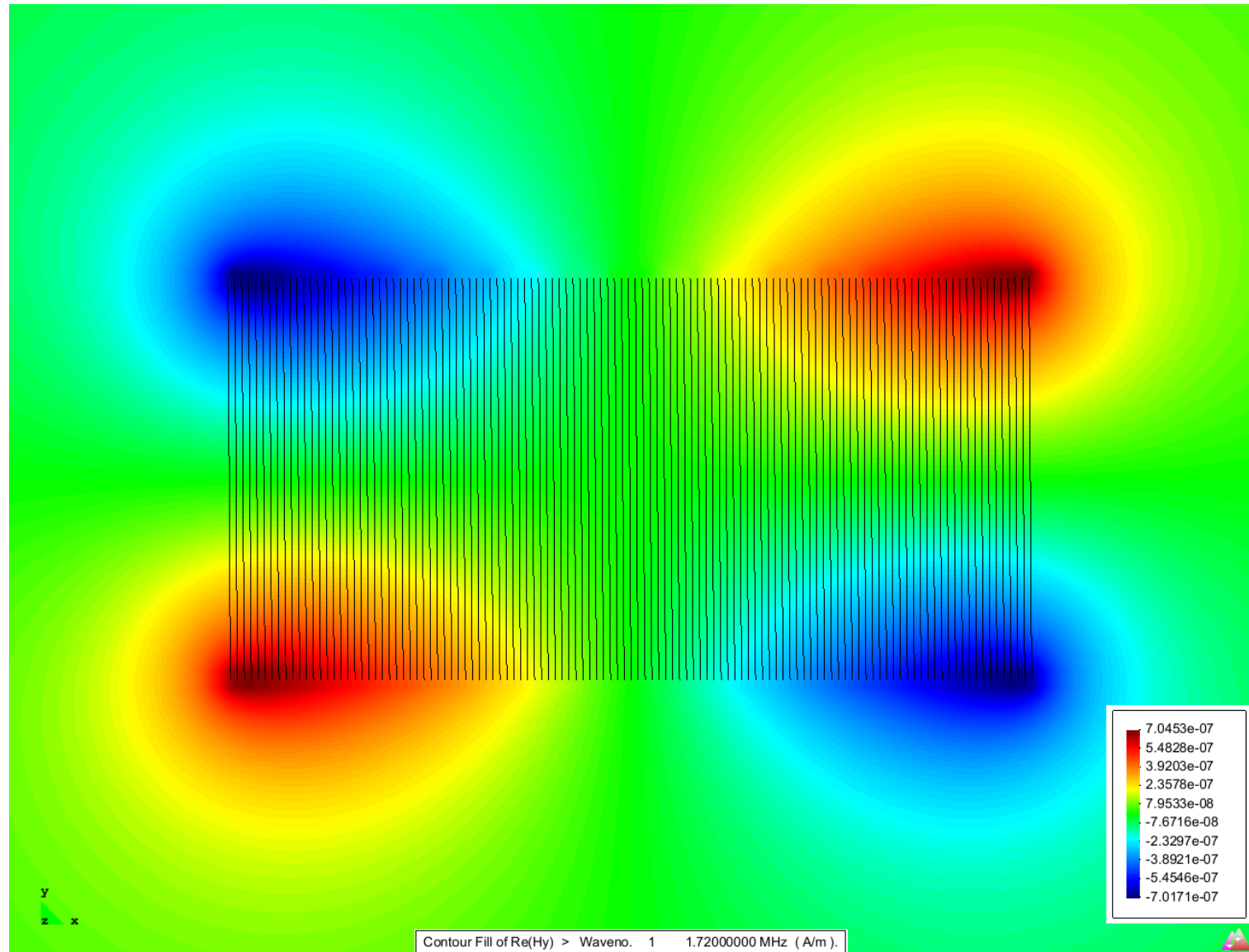



# 3,179 kHz – Transverse Vertical H – Signed

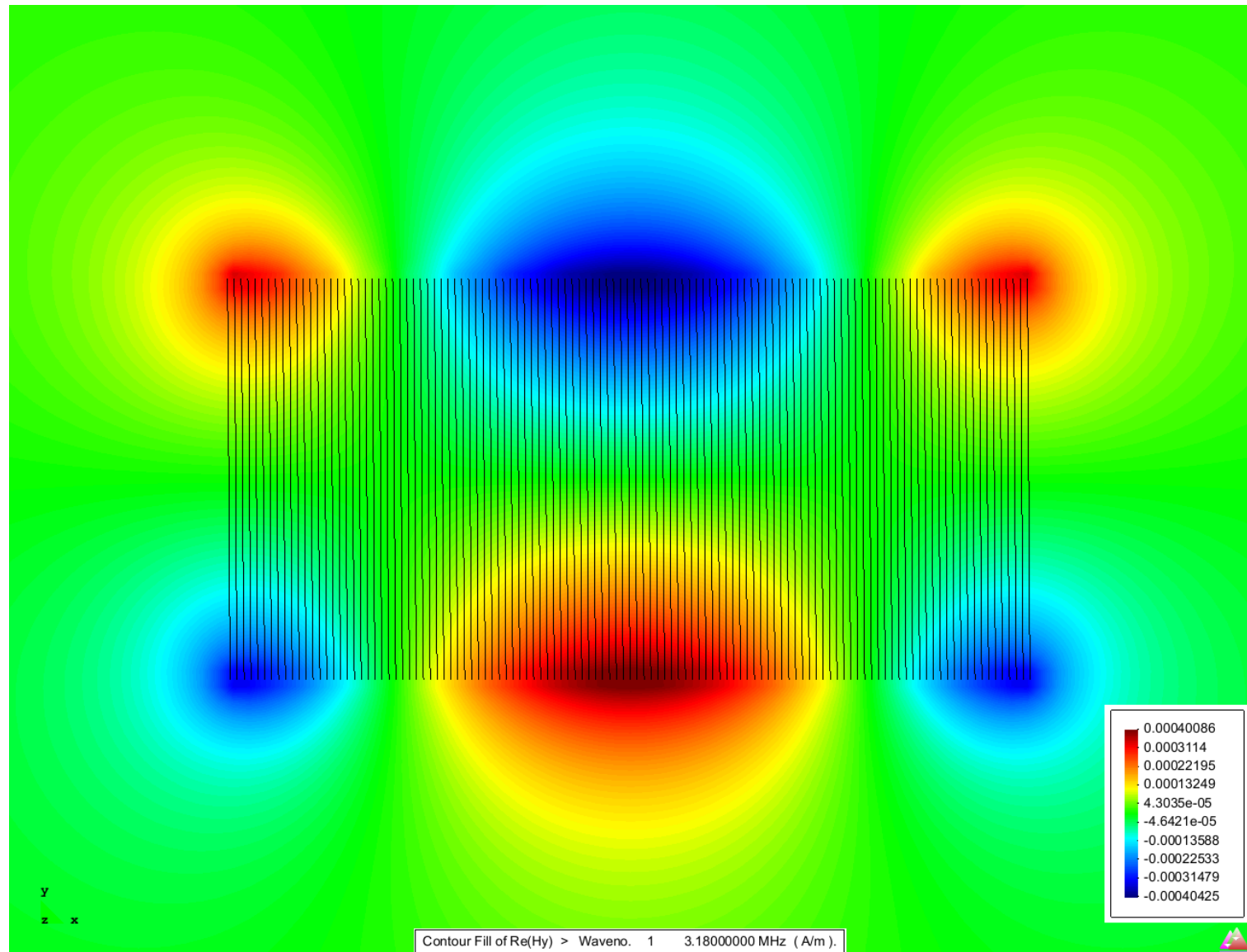



# 4,591 kHz – Transverse Vertical $H_y$ Signed

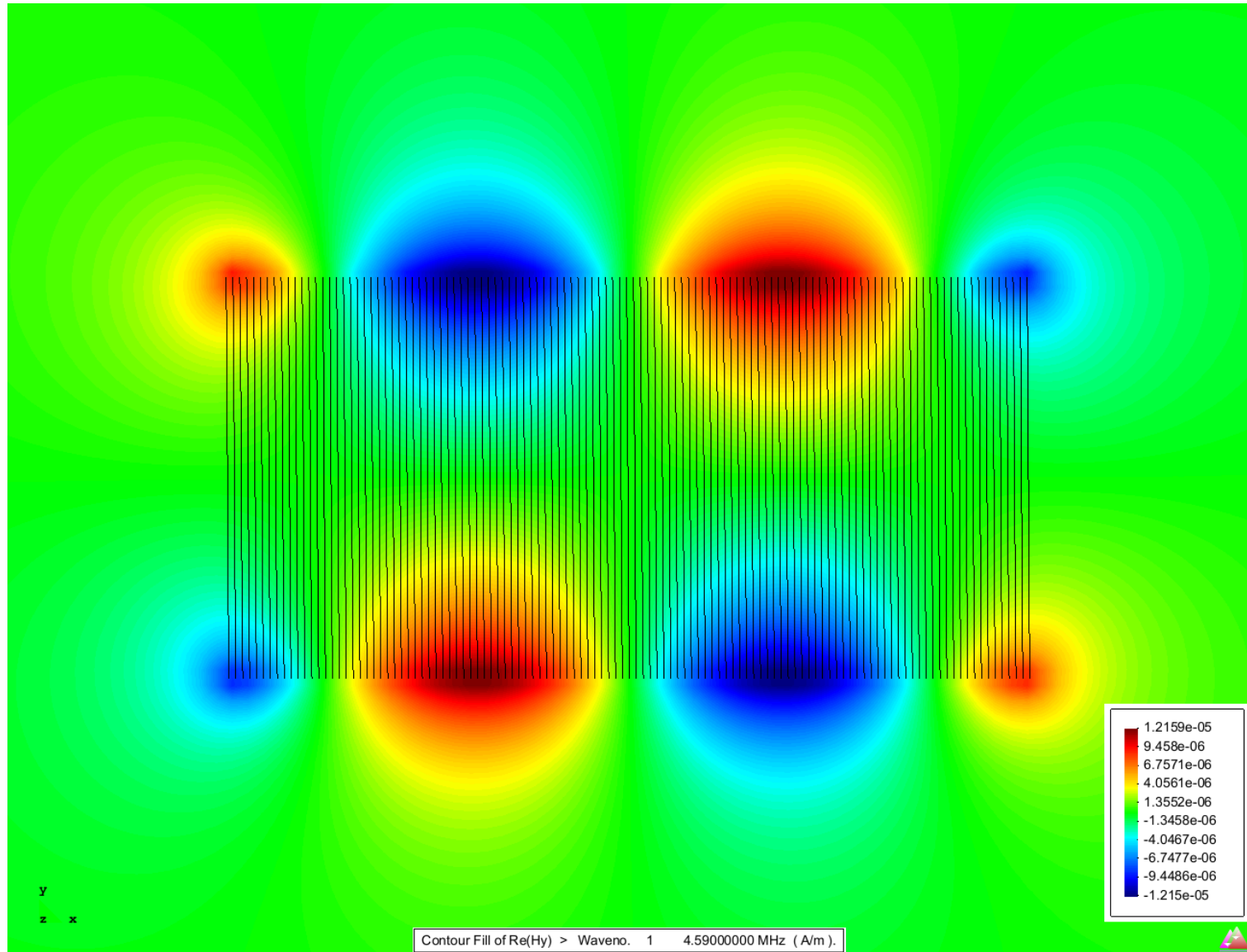

# 1,718 kHz – Total E Magnitude

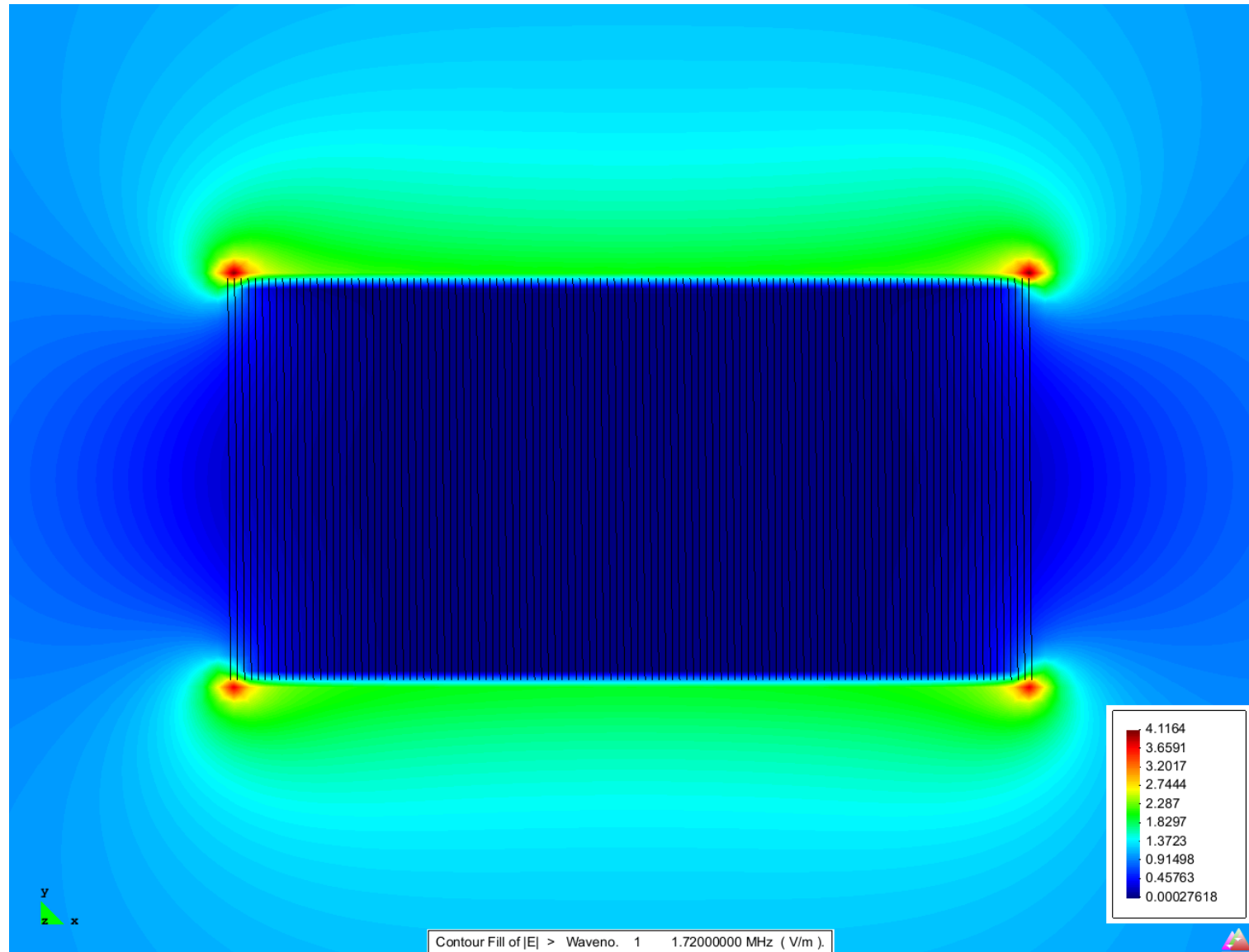

# 1,718 kHz – Axial $E_x$ Zoomed

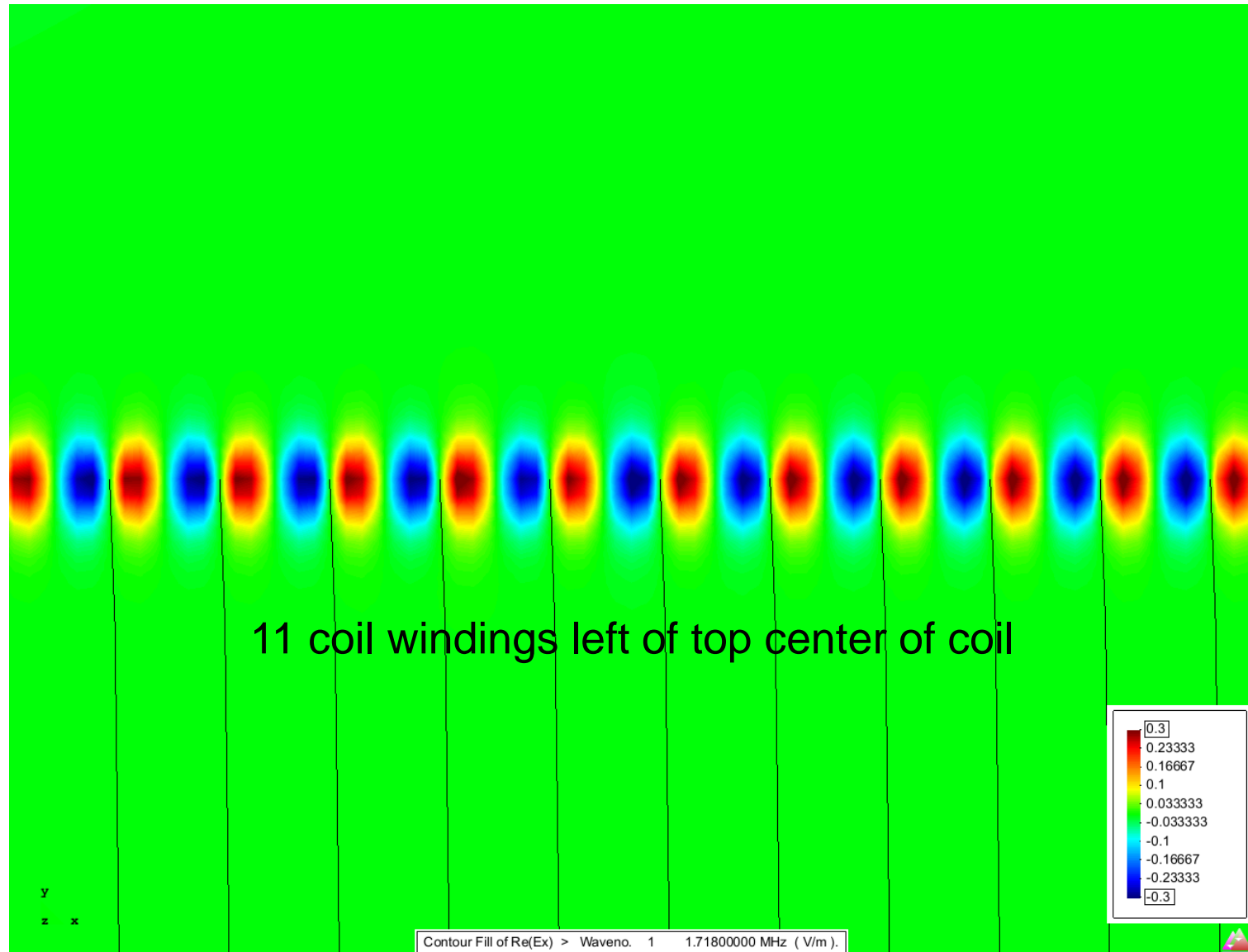

# 1,718 kHz – Transverse Out-of-Page $E_z$ Signed

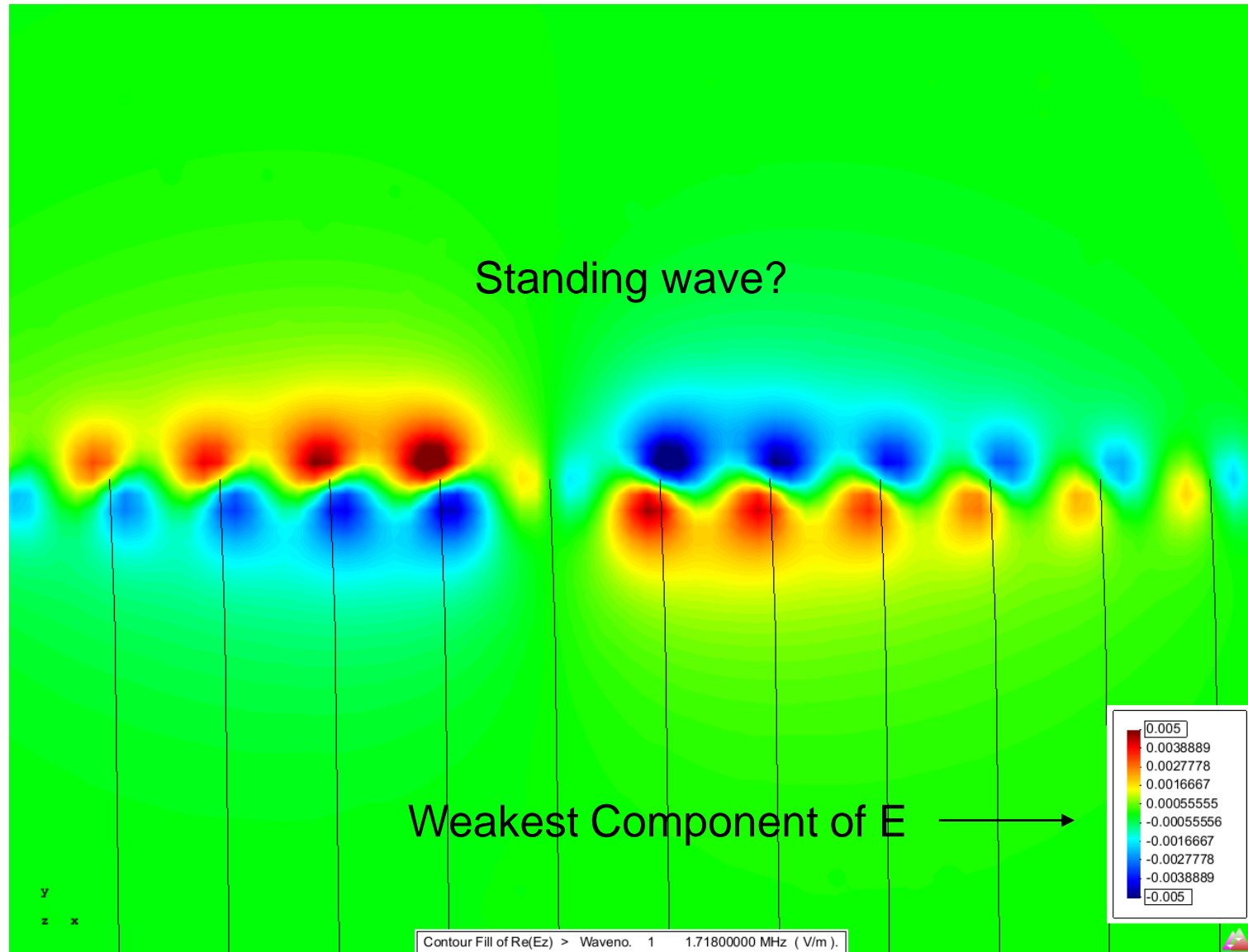

# Coil Showing Three Wires for Excitation

Generator on central axis wire

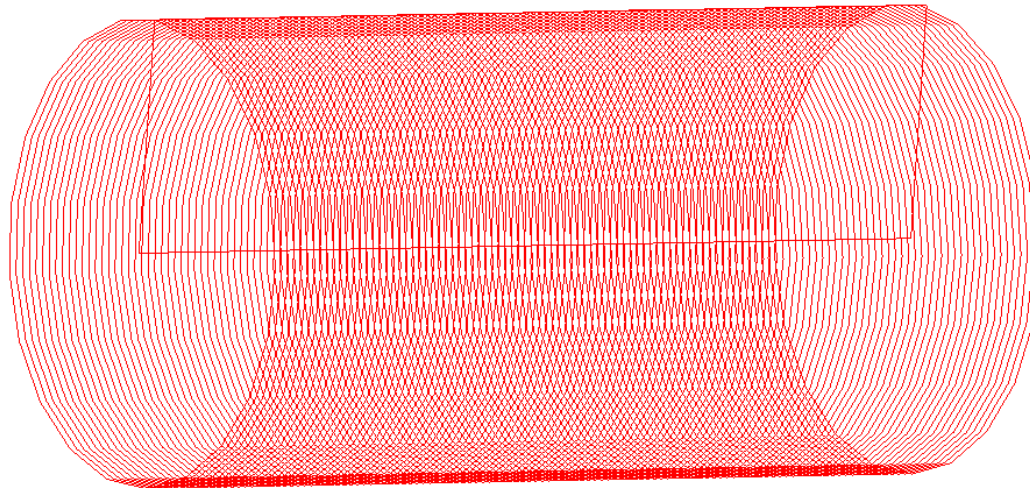

# Real Part of $Z = R + jX$ versus Frequency

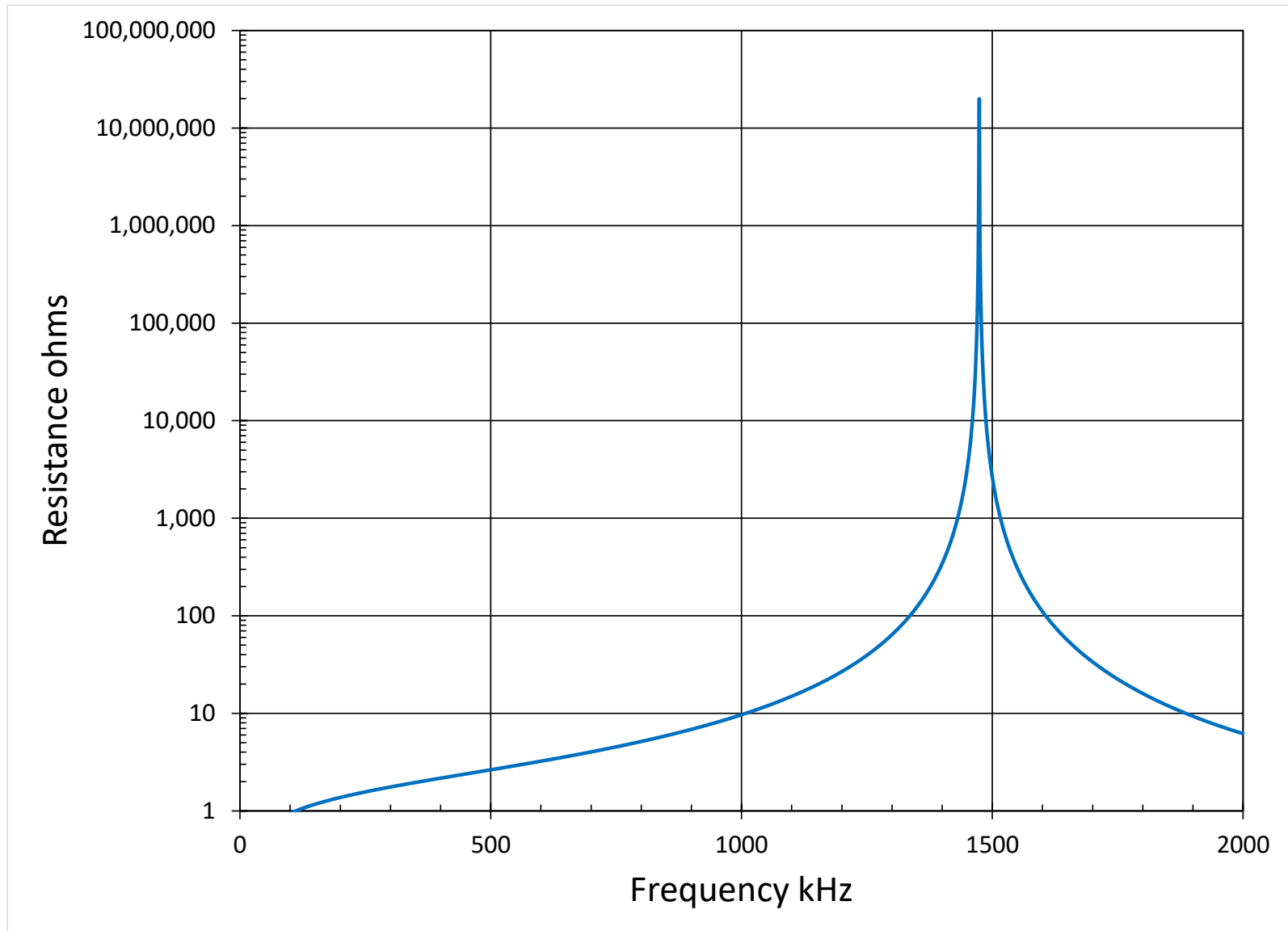

# Effective Inductance

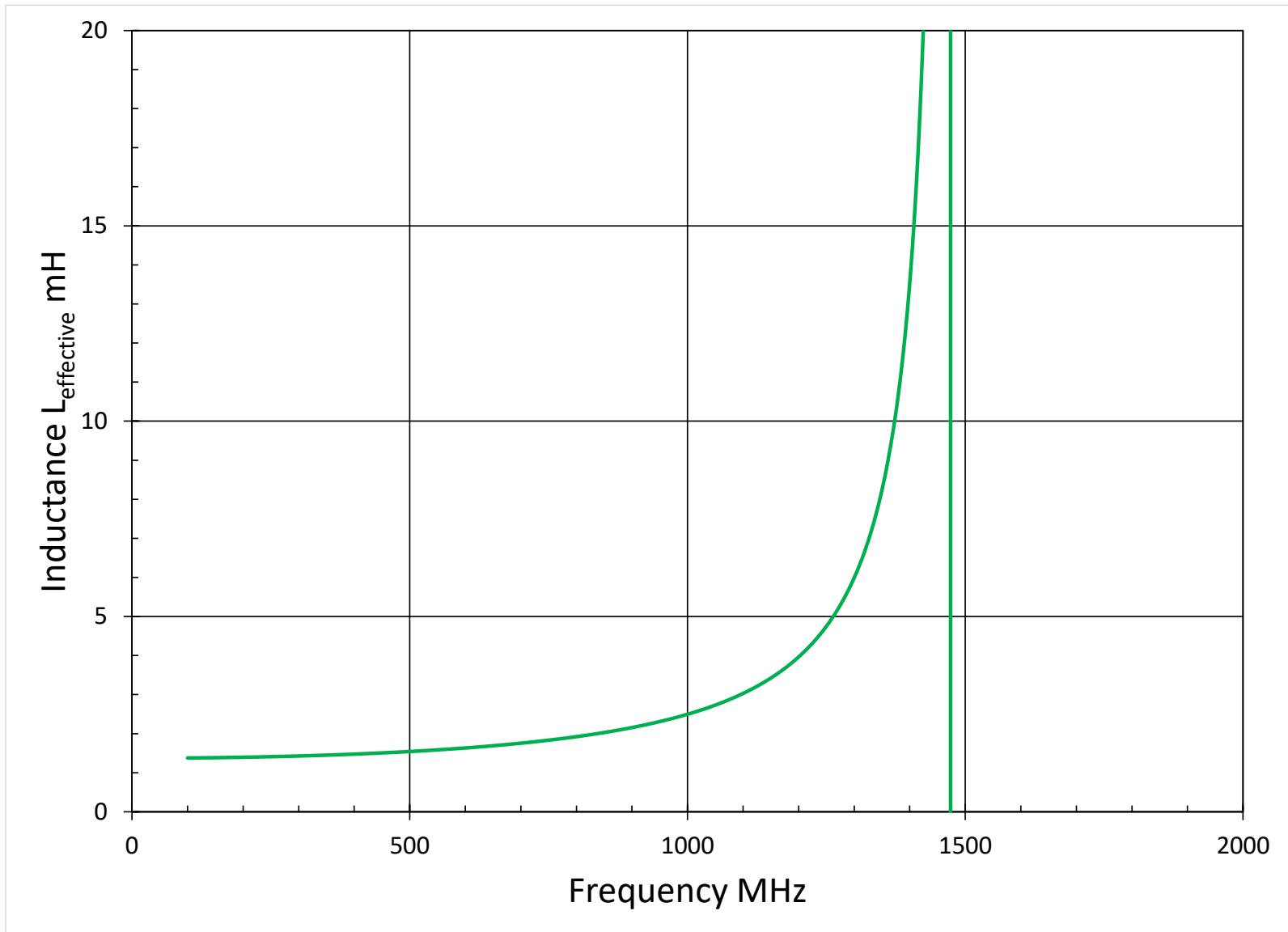

# Effective Q

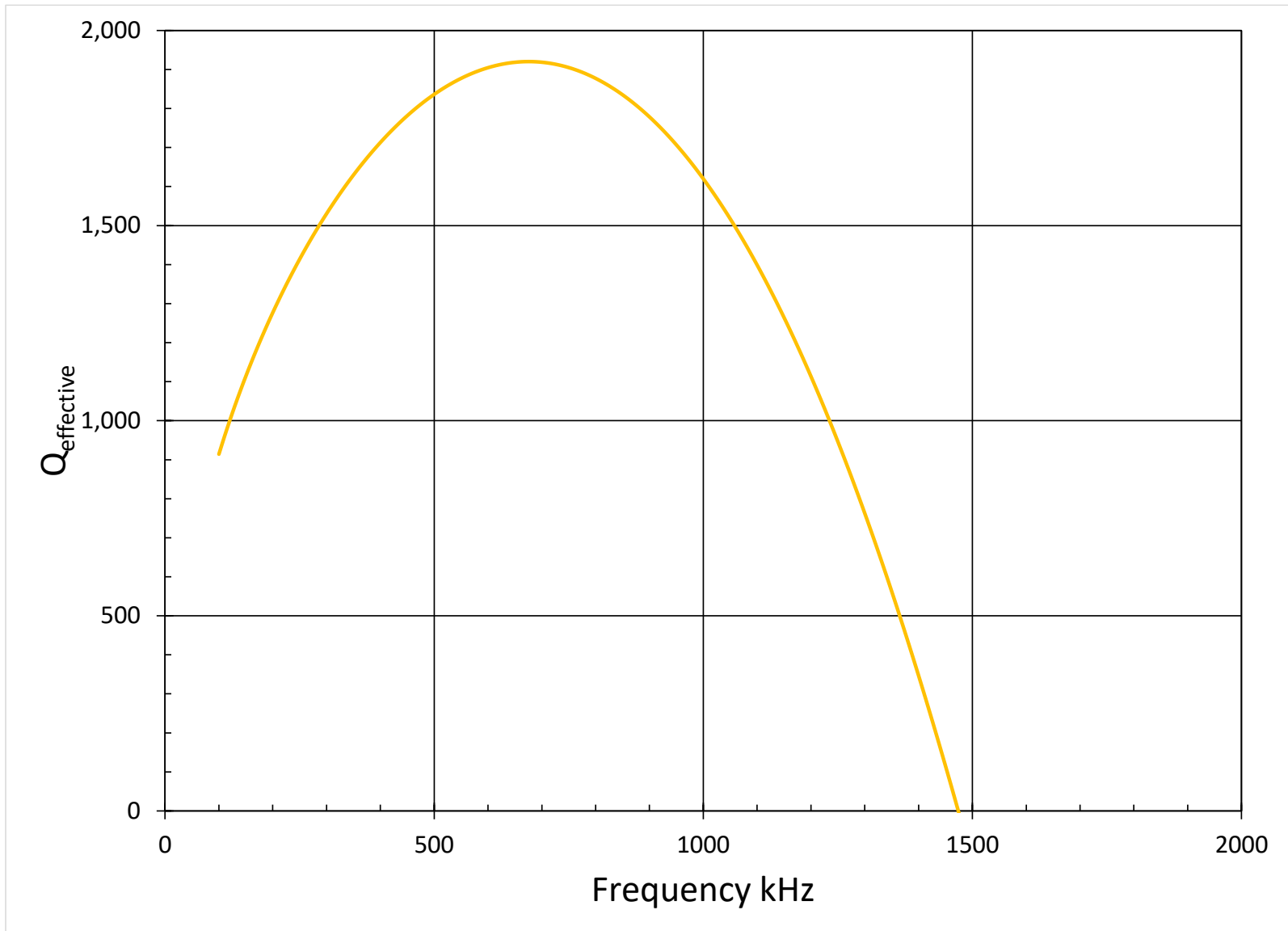



# Comments on Coil Self Resonance

- **Prior work on coil SRF**
  - David Knight, G3YNH – good work
  - Alan Payne, G3RBJ, (*QEX*, May/June 2011) – treats a coil as a transmission line
- **Coils stored E field energy is highly localized, not in the middle**
- **Localized E field explains inter-winding capacitance**
- **A broadband, lumped constant equivalent circuit of a coil that accounts for self resonant frequencies and skin effect can be obtained by classical methods of network synthesis**
  - Nobody has done this!
  - Must start from complex impedance vs frequency, not effective inductance or Q
- **Wrong Q formulas abound**
  - Q is the sum (not the difference) of E and H field energies divided by power
  - Q cannot be zero at resonance because stored E and H field energies are not zero
  - It is easy to derive wrong Q formulas if one starts with a wrong equivalent circuit; many contradictory Q formulas exist in the antenna literature
- **A single-layer coil is a finite helix**
  - A coil is a wave guiding structure but not a transmission line
  - Resonant frequencies are not harmonically or integer related or even equi-spaced as transmission line theory would predict
  - Transmission line model has wrong boundary conditions

---

# **Field Strength Inside Car for 2-meters Mobileers**

**FEKO and HOBBIES**

# FEKO Featured in QST, October 2016

## Near Fields of a Mobile Mounted 2 Meter Antenna

The author uses *FEKO*, a patch-based computational software package, to reveal EM fields around a vehicle.

Keith Snyder, K16BDR

*FEKO* is a computational electromagnetic (CEM) tool that I used to calculate the antenna pattern of a 2 meter antenna located on the center of the roof of a sedan-type automobile. *FEKO* computer code can calculate the electromagnetic fields both inside and outside the vehicle. I show images of the near fields around the vehicle.

Many radio amateurs are familiar with modern NEC-based computer software like *EZNEC* and *4nec2* used to calculate the fields of wire antennas and wire structures in the presence of a ground.<sup>1,2,3</sup> These computer software codes facilitate antenna analysis as a function of frequency, antenna height above ground, along with antenna patterns in presence of wire models of structures. The *FEKO* computer code is similar in that, like the NEC codes, it uses the method of moments (MOM) and the Sommerfeld ground capabilities.

### FEKO Software

*FEKO* uses triangular patches in the models so that we can represent arbitrary shapes such as the metal skin of an automobile or aircraft. *FEKO* stands for "feldberechnung für körper mit beliebiger oberfläche," which translates from German to "field calculations for arbitrarily shaped structures."<sup>4</sup>

I first encountered *FEKO* at the Applied Computational Electromagnetics Society meeting in Monterey, California in 2003. I met Dr C. J. Reddy, who helped me model a rolled-edge discone antenna. Later, I met Dr. Ulrich Jakobus, who wrote the code as part of his research activities at the University of Stuttgart in 1991. Capabilities of *FEKO* software include

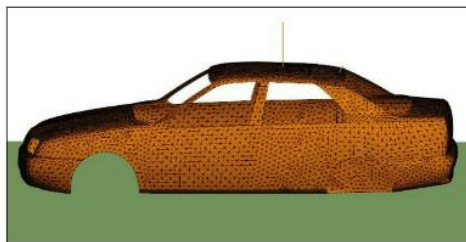

Figure 1 — Triangular patch model of a car includes a 19-inch wire antenna on the roof.

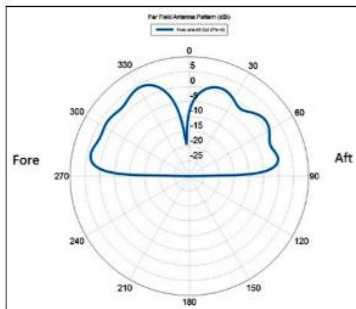

Figure 2 — Elevation pattern for a quarter-wave antenna on car at 147 MHz.

Finite Element Method (FEM), Method of Moments (MOM), Multi-Level Fast Multipole Method (MLFMM), Physical Optics/Geometrical Optics (PO/GO), and UTD (Uniform Theory of Diffraction).<sup>5</sup>

Steve Stearns, K6OIK, in a presentation to the Foothill Amateur Radio Society, has compared several CEM tools including a

few of the NEC software packages, along with *FEKO*.<sup>6</sup>

### The Vehicle Model

I found a generic car model on the *FEKO* software web page that is already meshed with simple triangle patches. I modeled a quarter-wave monopole antenna on the roof to see the near and far fields at 147 MHz. The 19-inch-tall monopole is located near the center of the roof. Figure 1 shows the patch model of a car with the monopole on the roof.

The car model is composed of 21,602 triangles. There are also 31 wire segments used to model the 2 meter monopole and a short antenna on the back of the roof

that is treated as a scatterer. The ground constants are a relative permittivity of 10, and conductivity of 0.005 S/m. The green plane under the car in Figure 1 indicates in *FEKO* that the Sommerfeld ground has been implemented.

The output of the computer code indicates that the antenna is near resonance with an

# Car with 2-Meter Monopole on Roof

---



Courtesy of Keith Snyder, KI6BDR



# Skin Currents

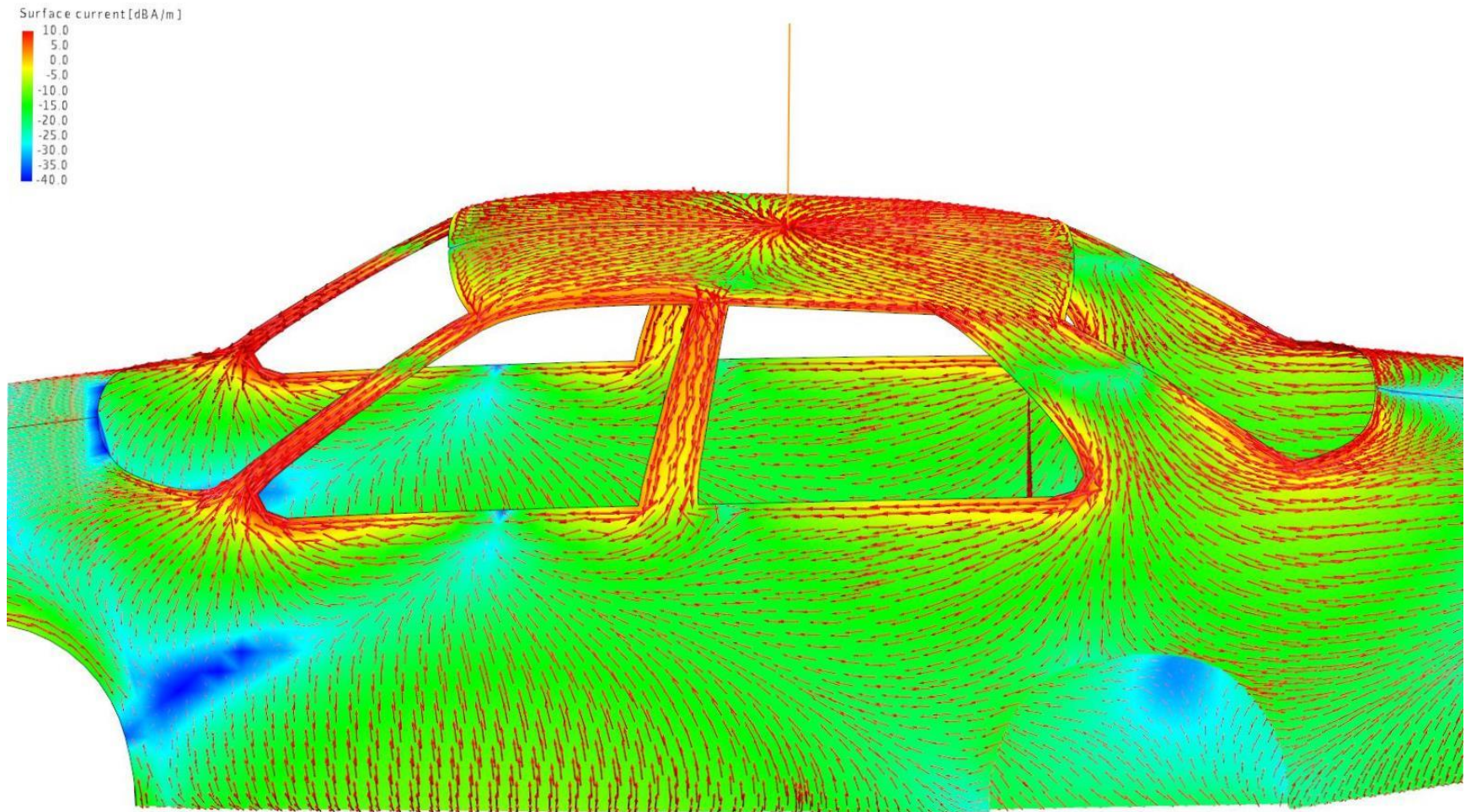

Courtesy of Keith Snyder, KI6BDR

# Electric Field Strength in Longitudinal Plane

XYZ E-Field [V/m]



Transmit power 75 watts

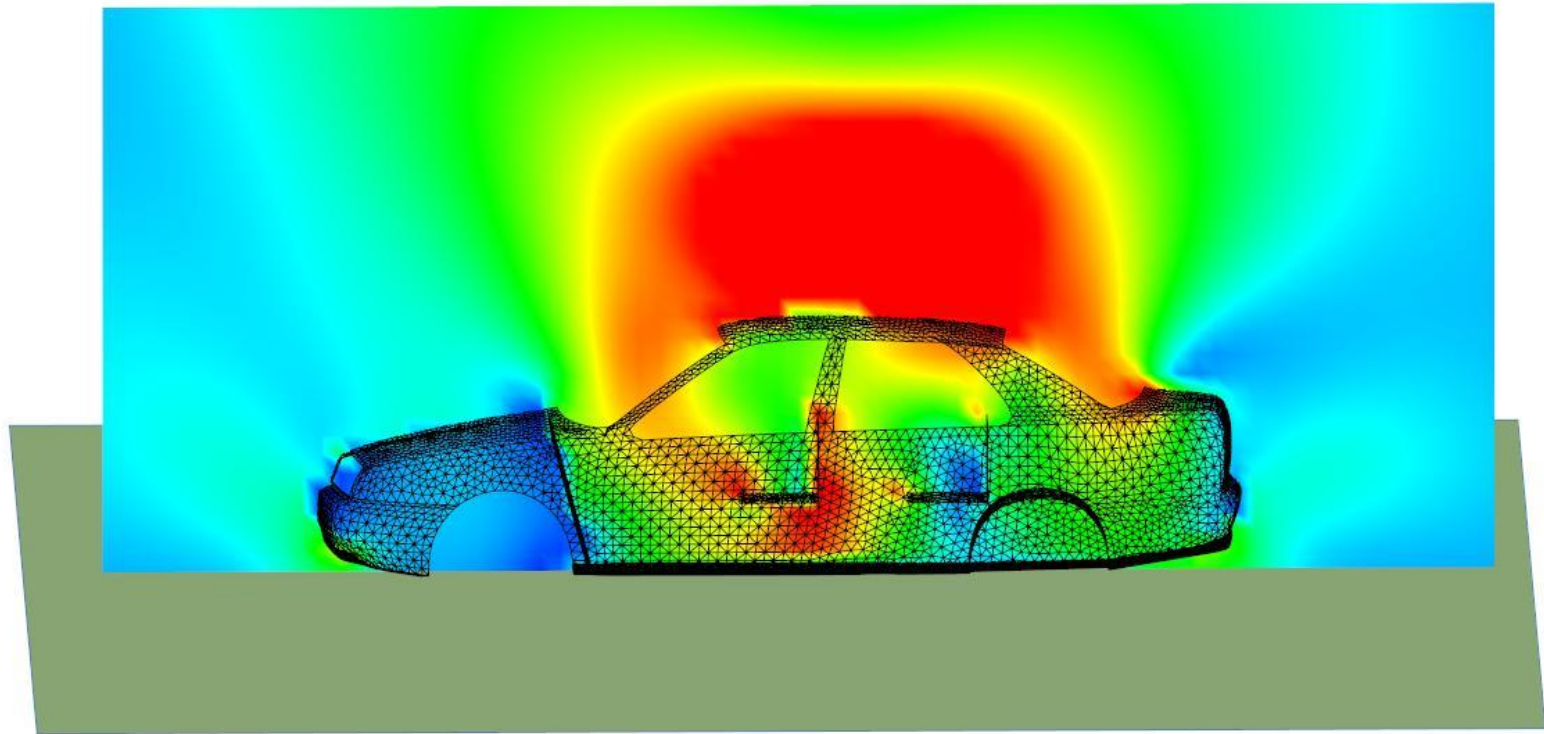

# Electric Field Strength in Transverse Plane

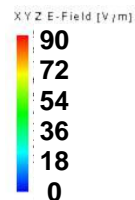

Transmit power 75 watts

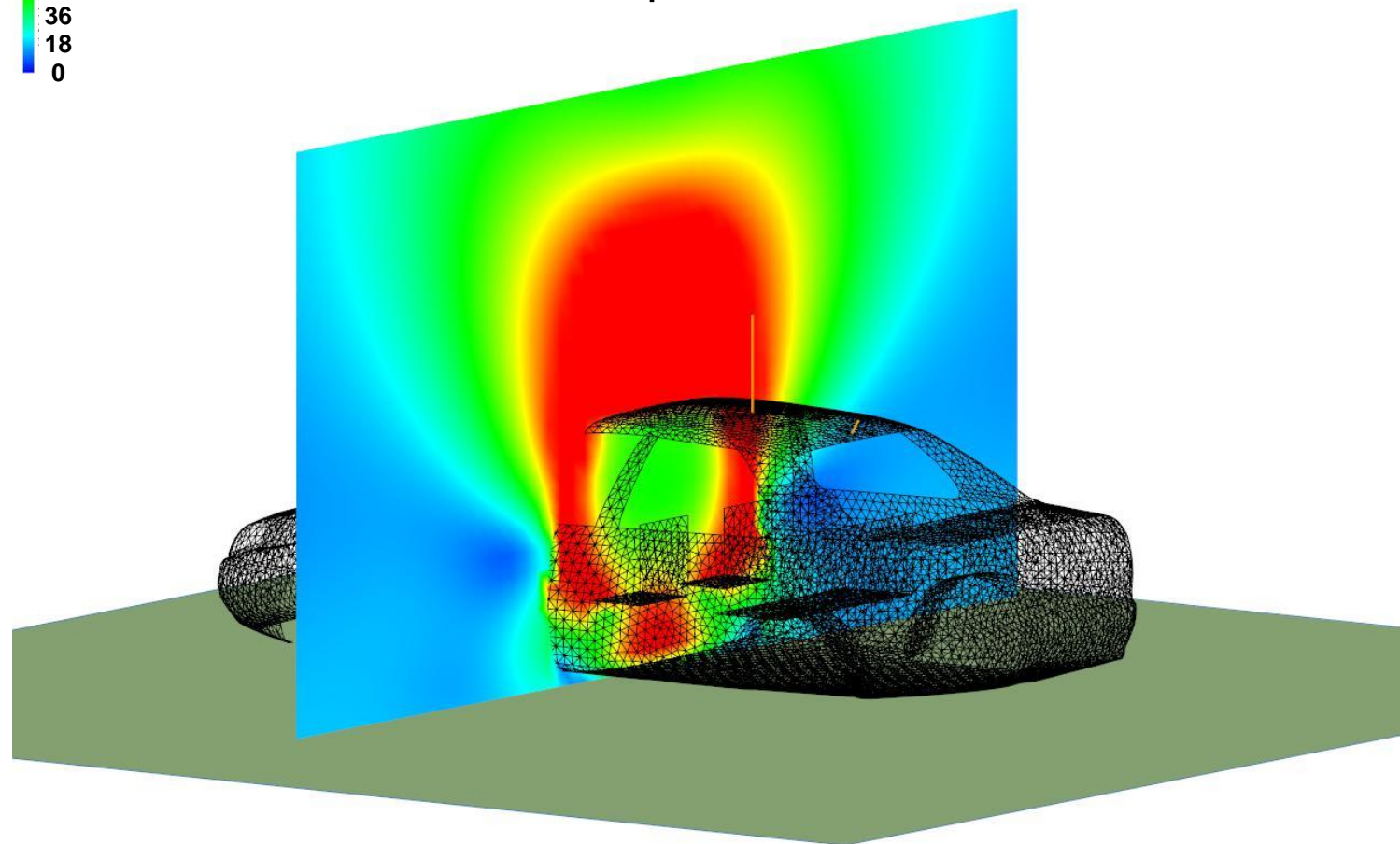

# Generic Car in HOBBIES

- Import .STL mesh file
- Convert .STL mesh to NURBS geometry
- Remesh using HOBBIES unstructured mesher
  - 2,903 nodes
- Add monopole in center of roof
  - Frequency 146 MHz
  - Length = 48.8 cm
  - Diameter = 4 mm
- Run HOBBIES
  - 5,664 unknowns
  - 92.3 seconds (pattern only)
  - 128.3 seconds (currents, pattern, near fields)
- Differences from FEKO model – minor stuff
  - Ground model turned off
  - Input power
  - Scaling of far field pattern shapes
  - Color sequence of pseudocolor scale



# Quadrilateral Bilinear Surface Mesh

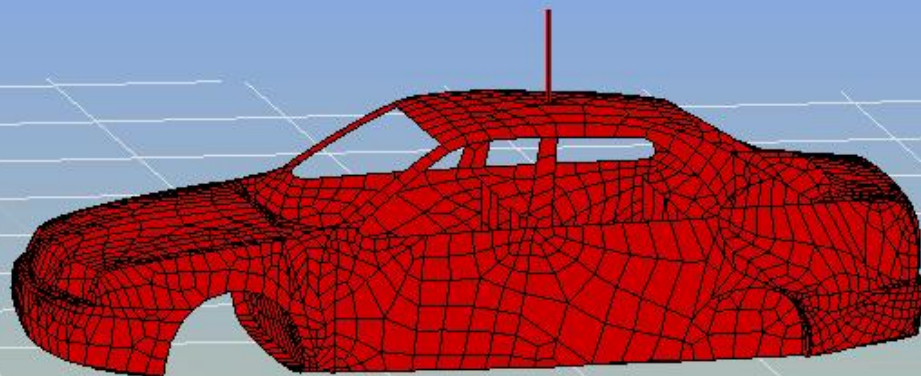

Ground model is off. Car is in free space.



# Pattern – Max Gain 2.713 dBi

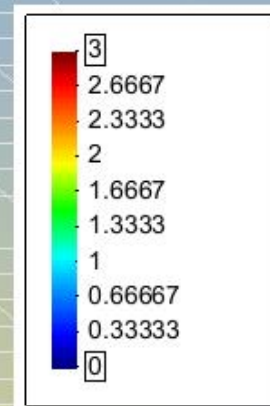
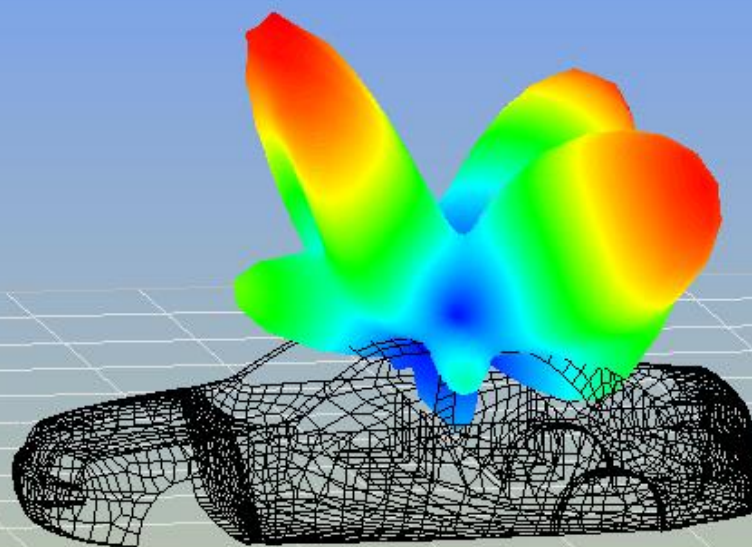

Contour Fill of Total - Gain > Gen.no. 1 146.00000000 MHz ( U ).

Patterns are scaled linearly, not in dB or ARRL scaling

# |E| Field in Central Plane (y = 0)

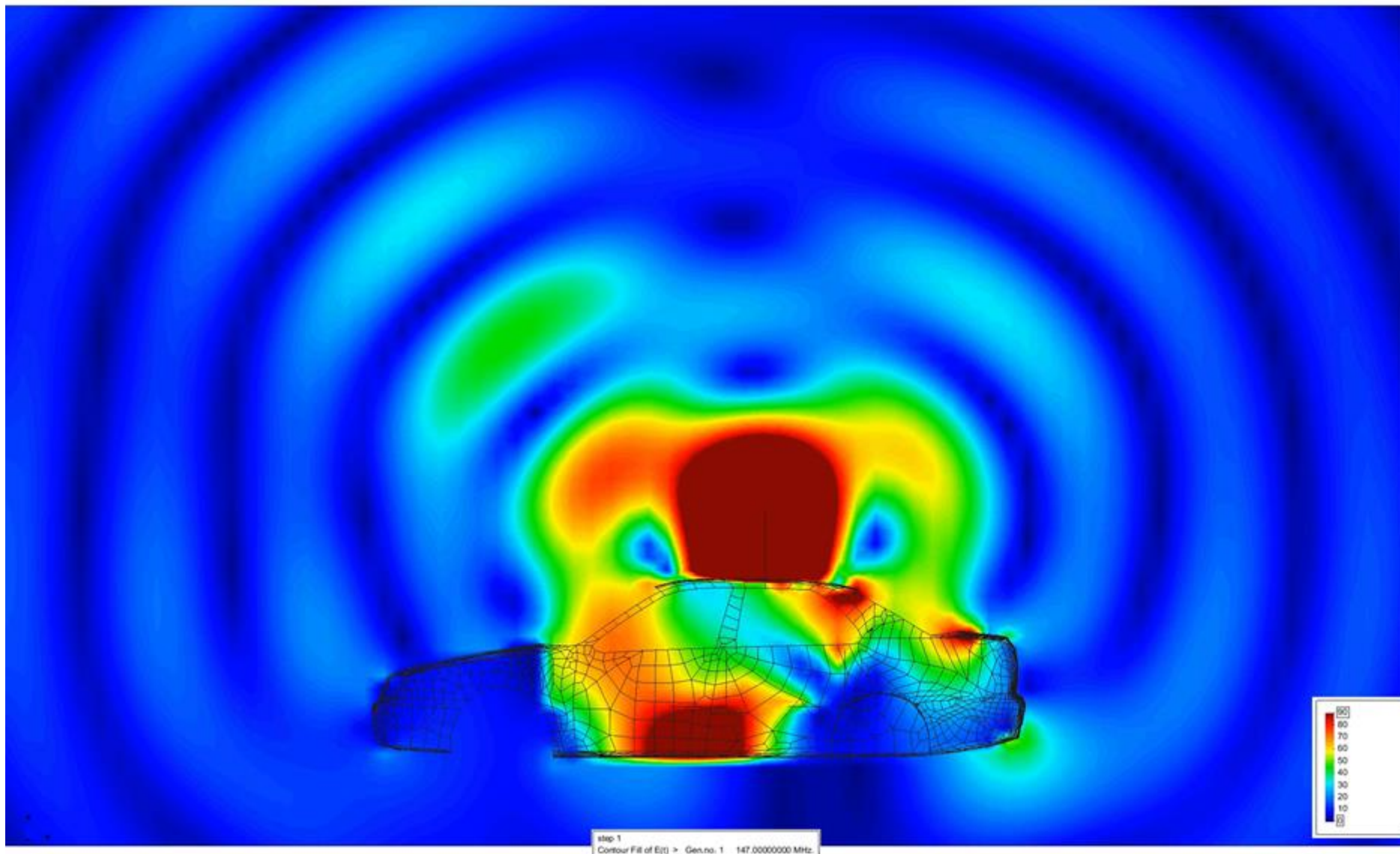

# Summary

---

- **A car is not a Faraday cage**
  - Many Amateurs use 2-meter HTs from inside their cars
- **A car's cabin is an irregularly shaped cavity resonator with apertures (windows)**
- **Windows couple exterior and interior fields at 2 meters**
- **Currents around apertures couple exterior and interior fields**
- **Electric and magnetic fields inside a car can be measured and computed by modern CEM software**
- **Measurement and computation have good agreement if**
  - Measurements are made carefully
  - Computer model has good detail
- **Modern CEM tools give radio amateurs new capabilities**
  - Model surfaces more accurately than wire grid models
  - Include dielectric objects and surfaces in models
  - Compute fields in and around objects with high accuracy

---

# **Terrain Modeling, the Alternative to HFTA**

**FEKO and WIPL-D**



# Terrain Modeling, the Alternative to HFTA

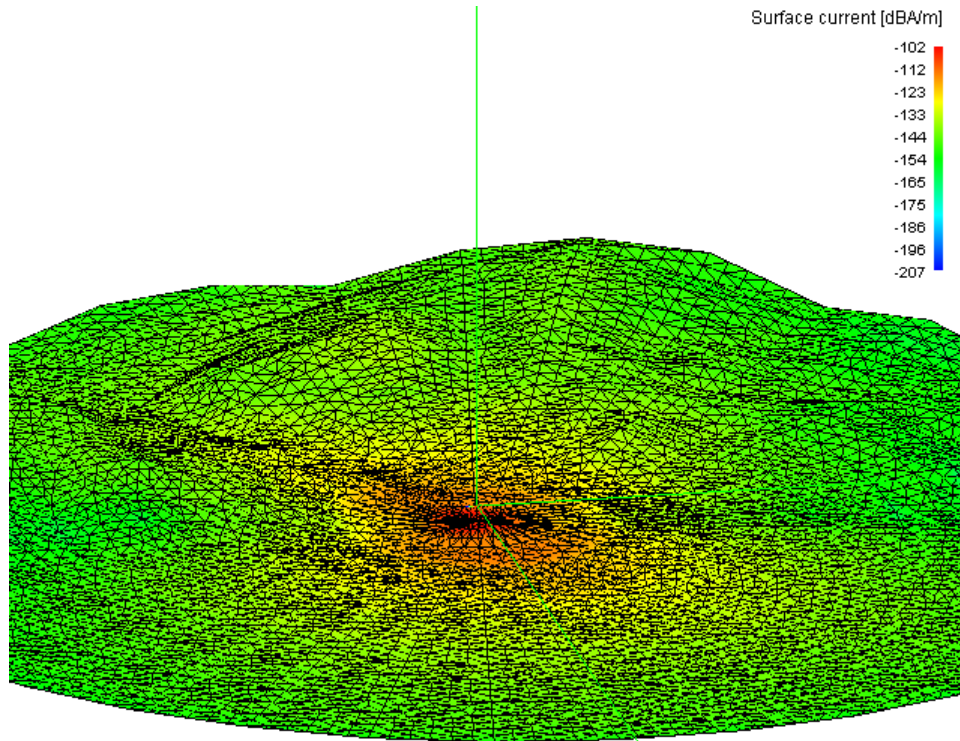

Surface meshed terrain of Saratoga, CA  
Color indicates computed earth currents  
Zoom to see current direction arrows

Earth terrain looking down  
Saratoga-Sunnyvale Road

# Ground Currents

Frequency = 7.15 MHz

Antenna type = 3 element Yagi

Antenna height = 164 ft (50 m)

Antenna polarization = horizontal

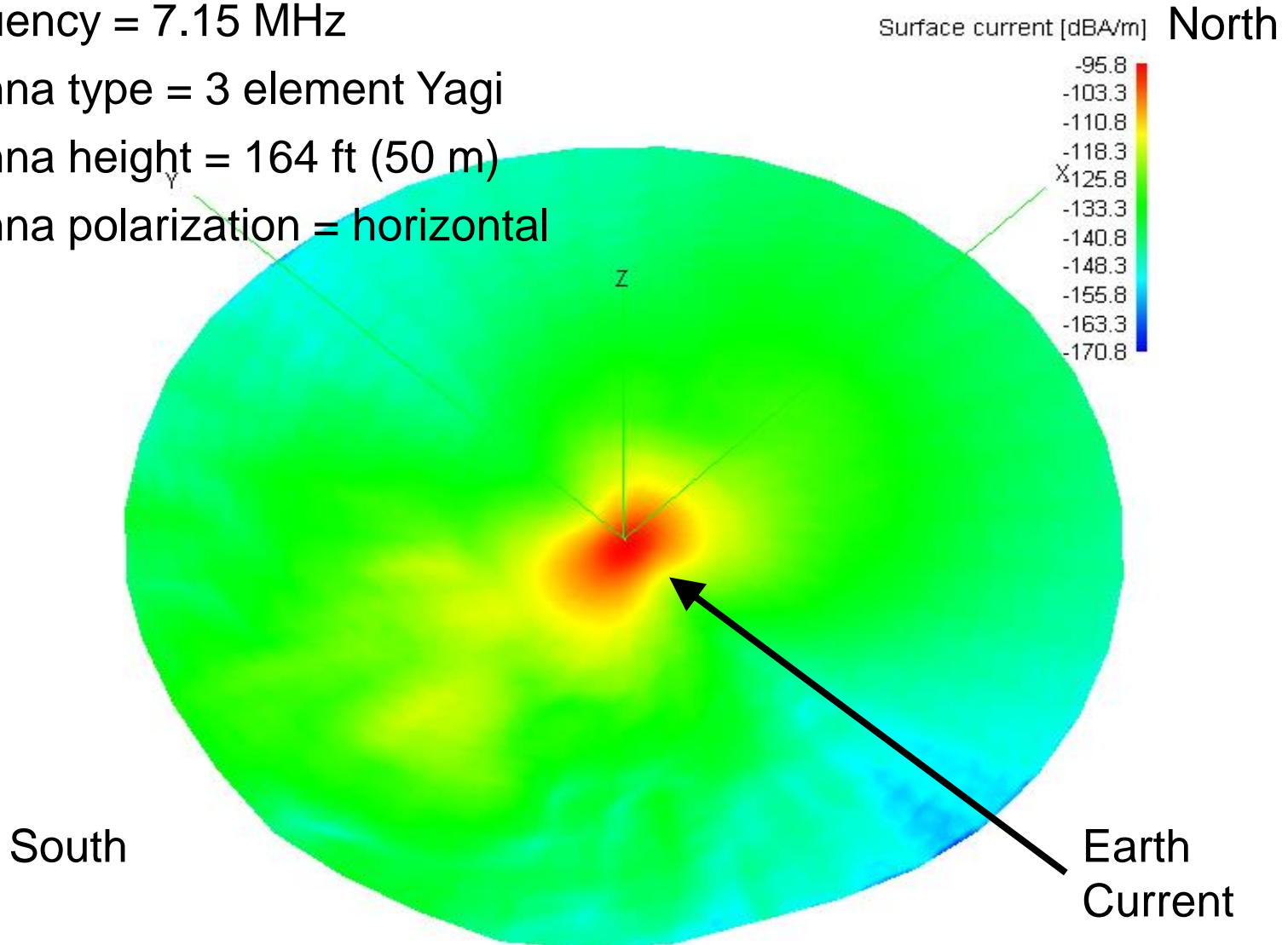

# 3D Antenna Pattern

Frequency = 7.15 MHz

Antenna type = 3 element Yagi

Antenna height = 164 ft (50 m)

Antenna polarization = horizontal

$|E|$  field pattern shown

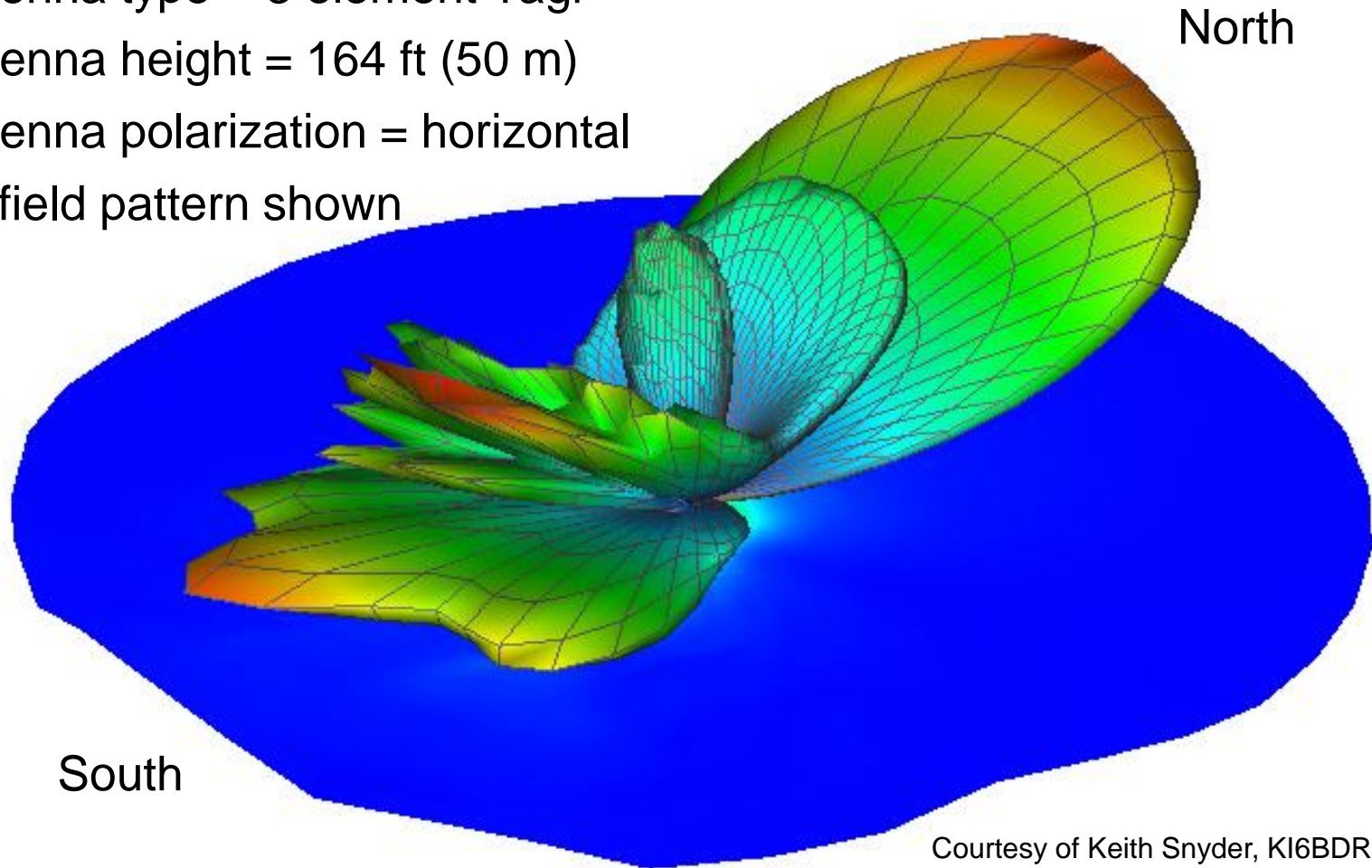

Courtesy of Keith Snyder, KI6BDR



# Computation Statistics

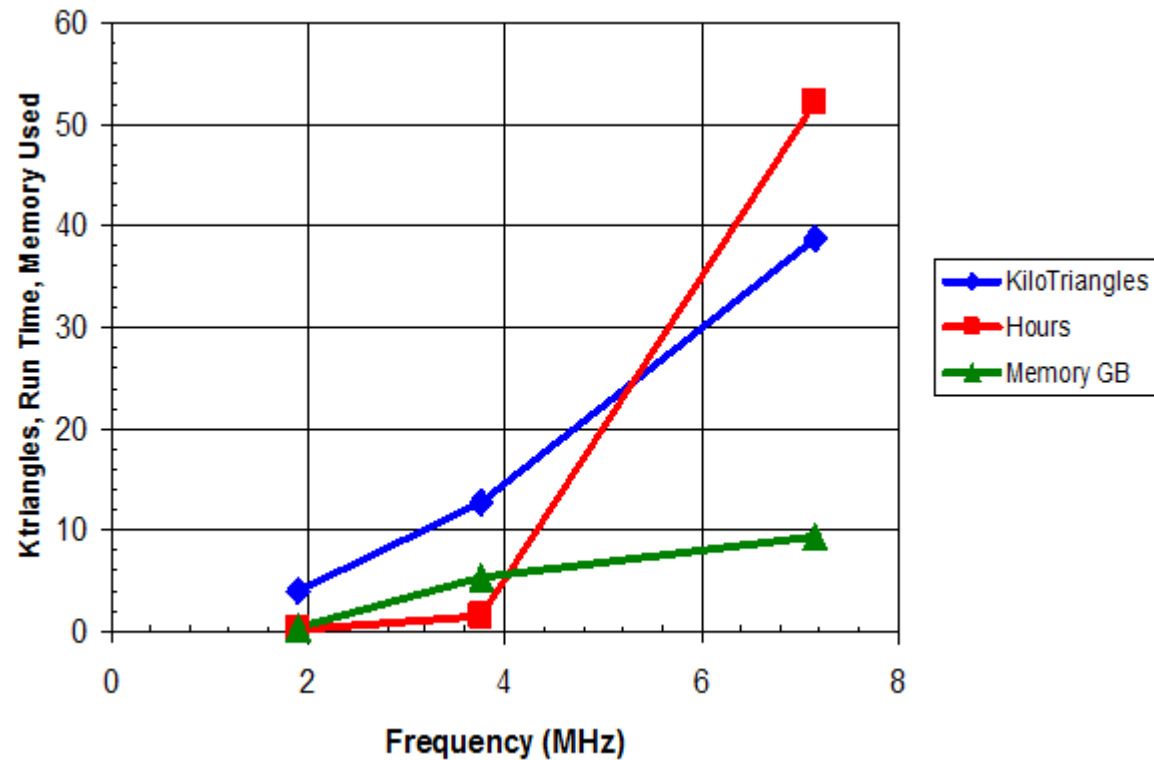

Computer	6 Xi NetRAIDer network servers
Processors	12 AMD Opteron 64-bit
Memory	96 Gbytes
Disk storage	12 Tbytes
Compute speed	> 53 GFLOPs/sec

Frequency (MHz)	Triangles	Hours	Memory (GB)
1.900	3,928	0.125	0.53
3.750	12,834	1.54	5.48
7.150	38,717	52.1	9.38

# The Next Step – Add Landscaping to the Model

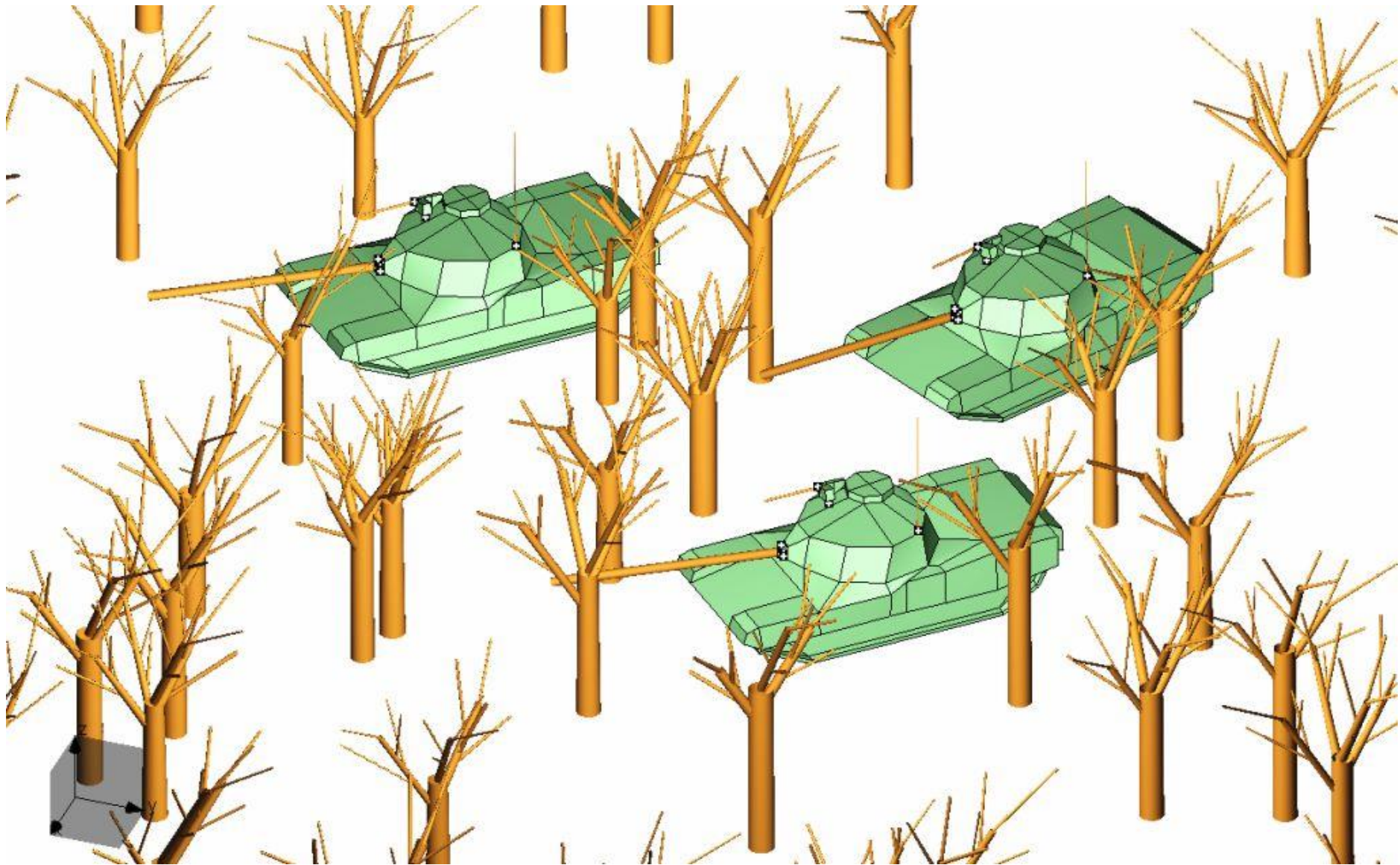

# Landscaping Details

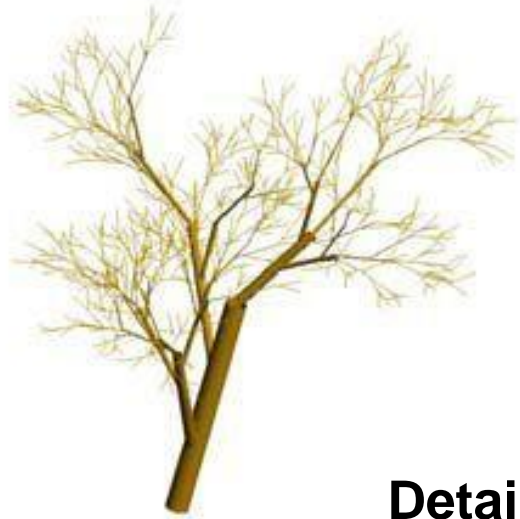

**Models of trees**



**Details of leaves and branches**



Courtesy of WiPL-D

---

# **Monopole on Planet Sphero**

**Because the Earth is not flat!**

**HOBBIES**

# Question for 2018

- A drunk and dyslexic ham makes a yagi
- He adds a director to a dipole
- Being drunk and dyslexic, he mistakenly puts it at the end of the dipole instead of in front of it
- His yagi looks like this

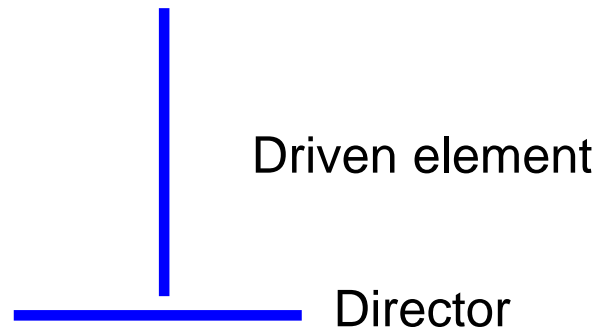

- Question: Can this work? Can the “director” pull the radiation pattern toward it?
- Dint (drunk’s hint): If you put a vertical dipole over any ground (except perfect ground), the pattern’s lobes lift upward. Right?



# Vertical Antenna on Non-flat Ground "Plane" with Trees

- 160-meter vertical monopole
- Fed against: a driven ground rod, buried radials, elevated radials
- Planet is: Arizona soil, sandy, rocky; or seawater
- Planet originally had an iron core, later removed
- 4 California redwood trees (trunks) surround vertical
- Planet kept small for fast run time
- HOBBIES computed fields and currents inside and outside of planet
- 2.5 minutes on a 12-core Windows 10 machine
- All 12 cores maxed at 100% for ~ 150 seconds

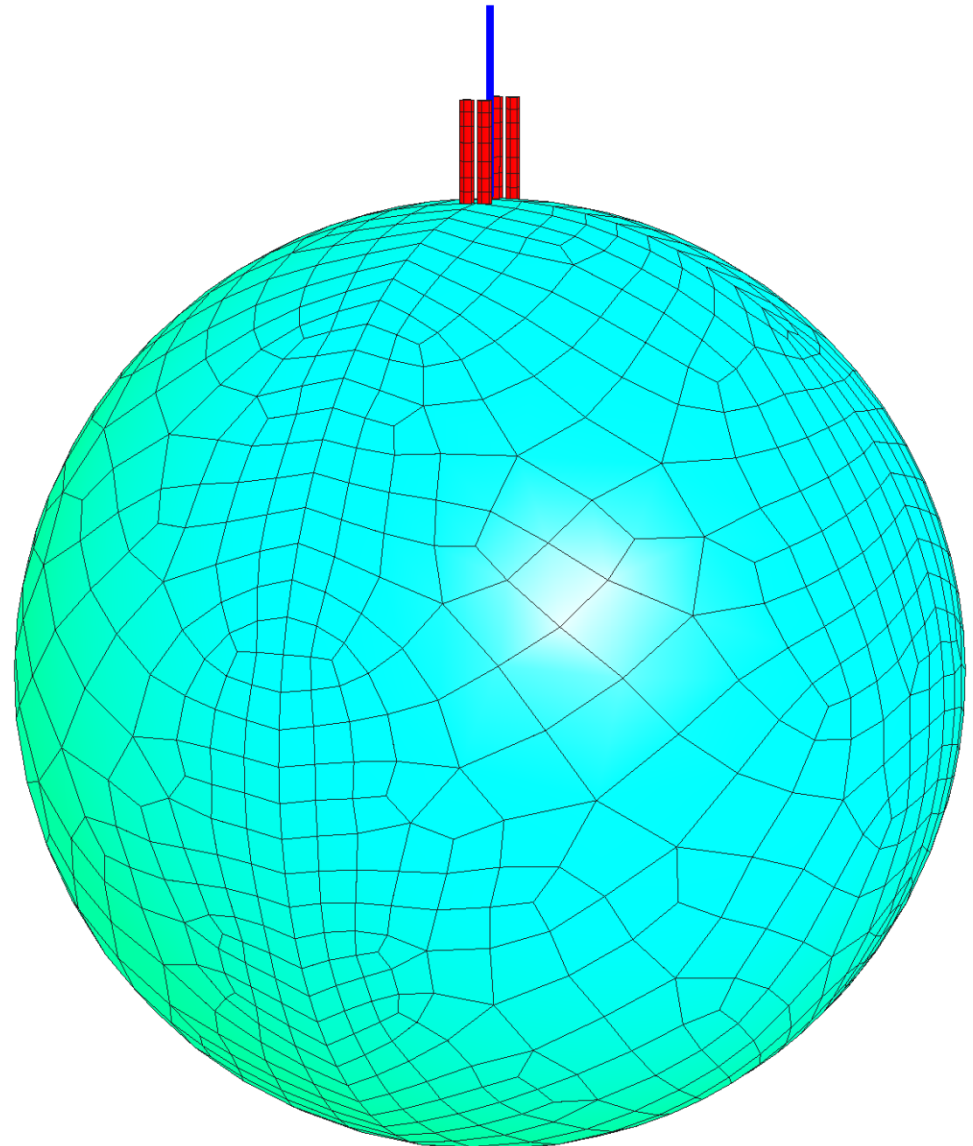

# Symmetry Planes Speed Computation

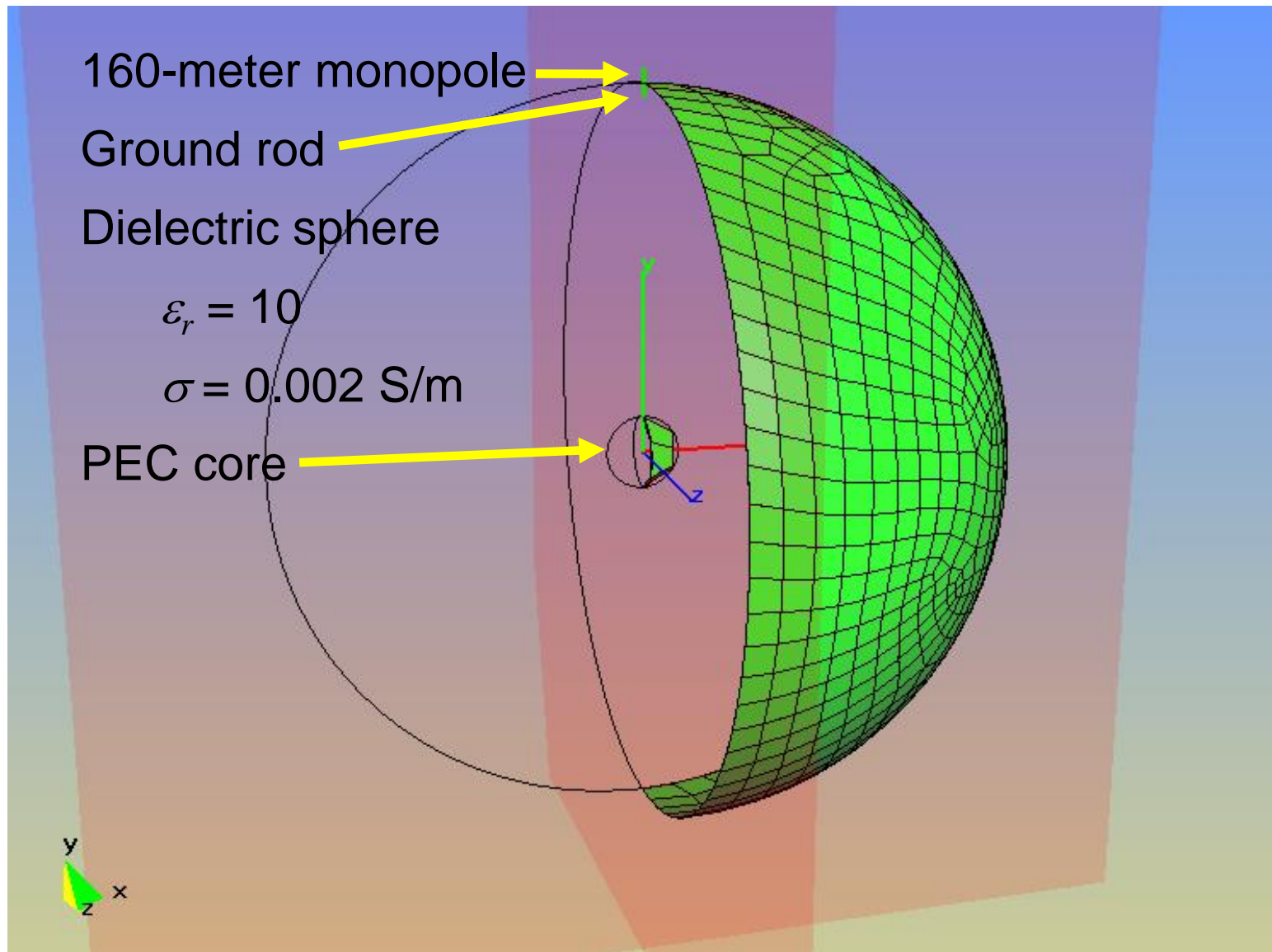

# Far Field Pattern Puts Energy in Lower Hemisphere

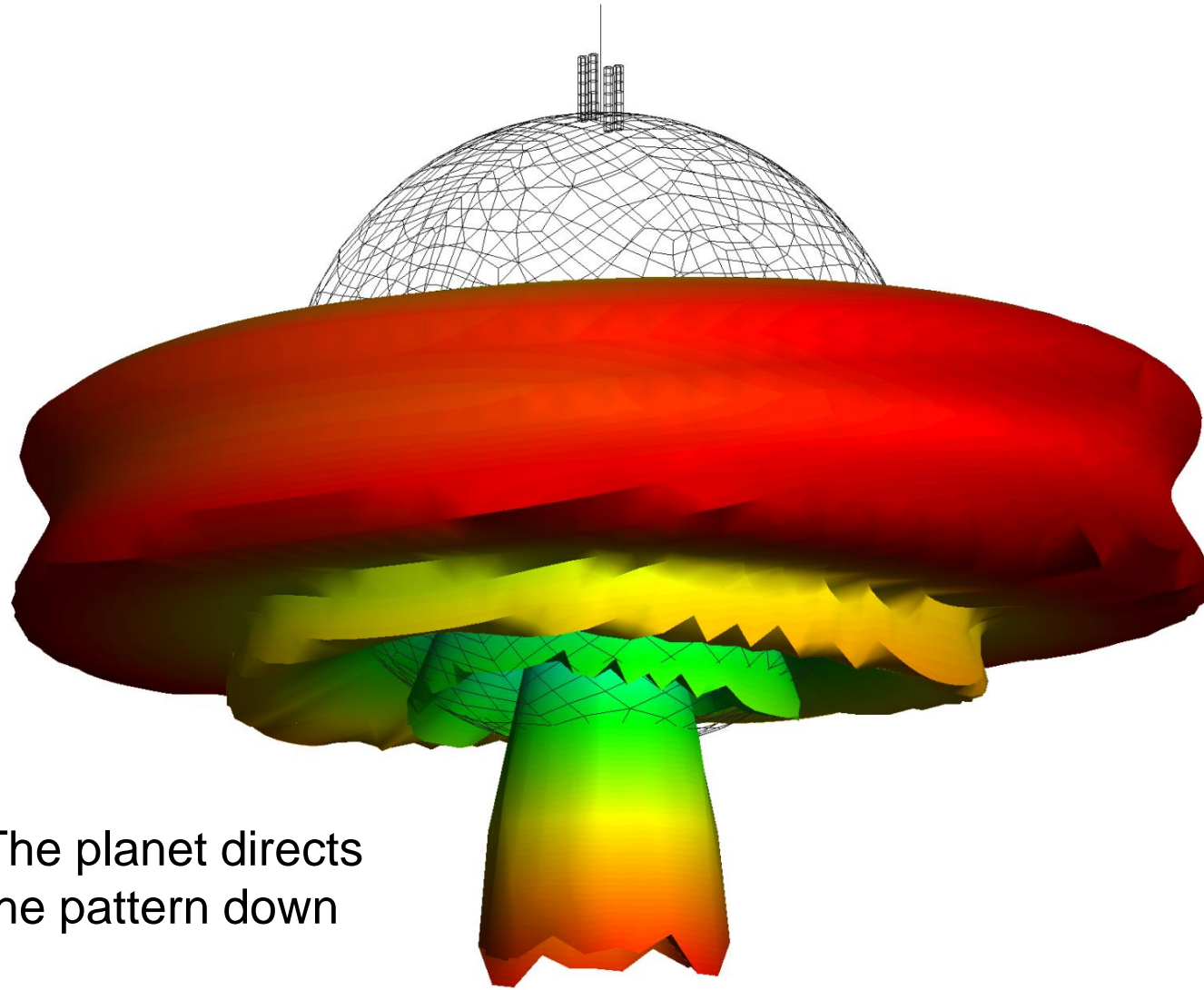

The planet directs  
the pattern down

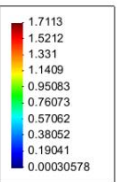

Contour Fill of Total - Gain > Gen.no. 1 1.90000000 MHz ( U )



# More Energy Goes Down than Up

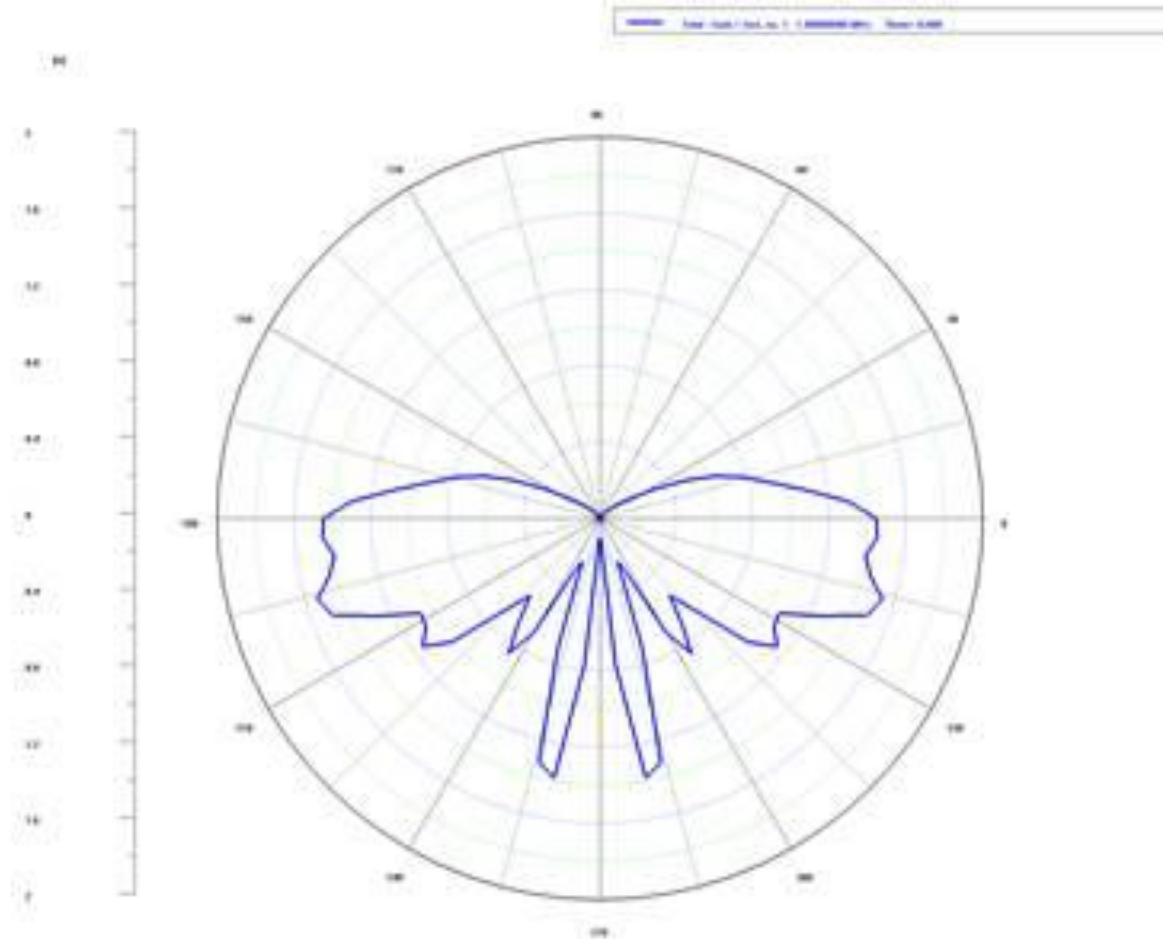

# Why? – Ground Wave Physics

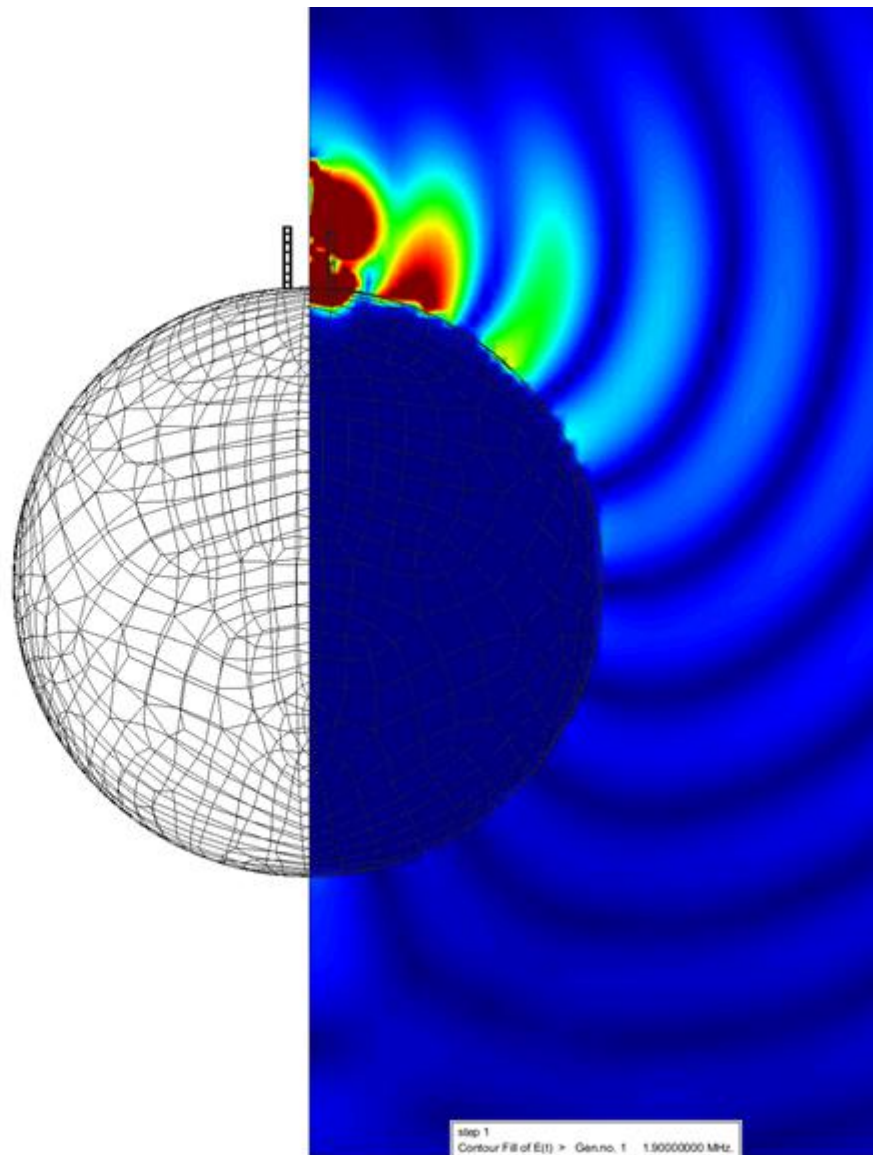

Wave is initially bound to the planet

Planet guides the wave until field lines detach

This planet is small enough to guide the ground wave to the other side

Field line detachment occurs near the bottom

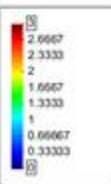

# Surface Current

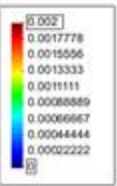
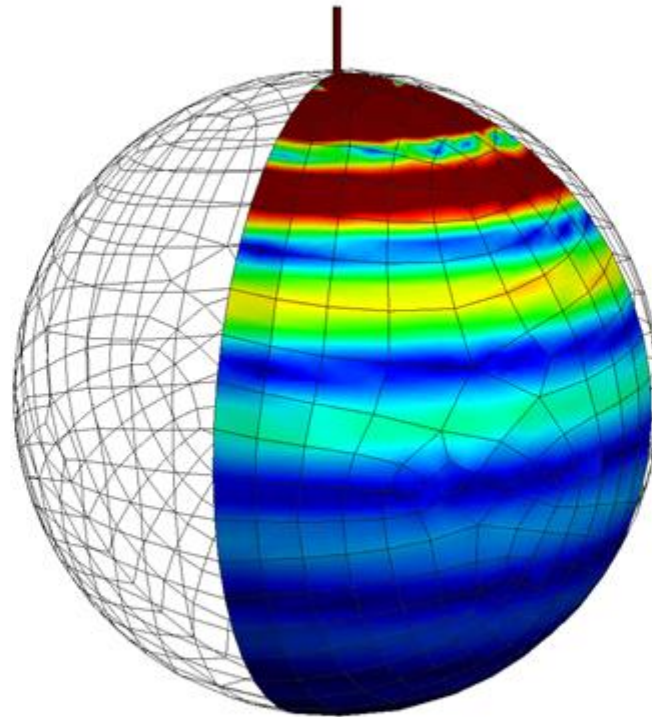

step 1  
Contour Fill of J01 > Gen.no. 1 1.90000000 MHz.

---

# **Baking a Potato**

**MEFiSTo**

# Potato In Microwave Oven

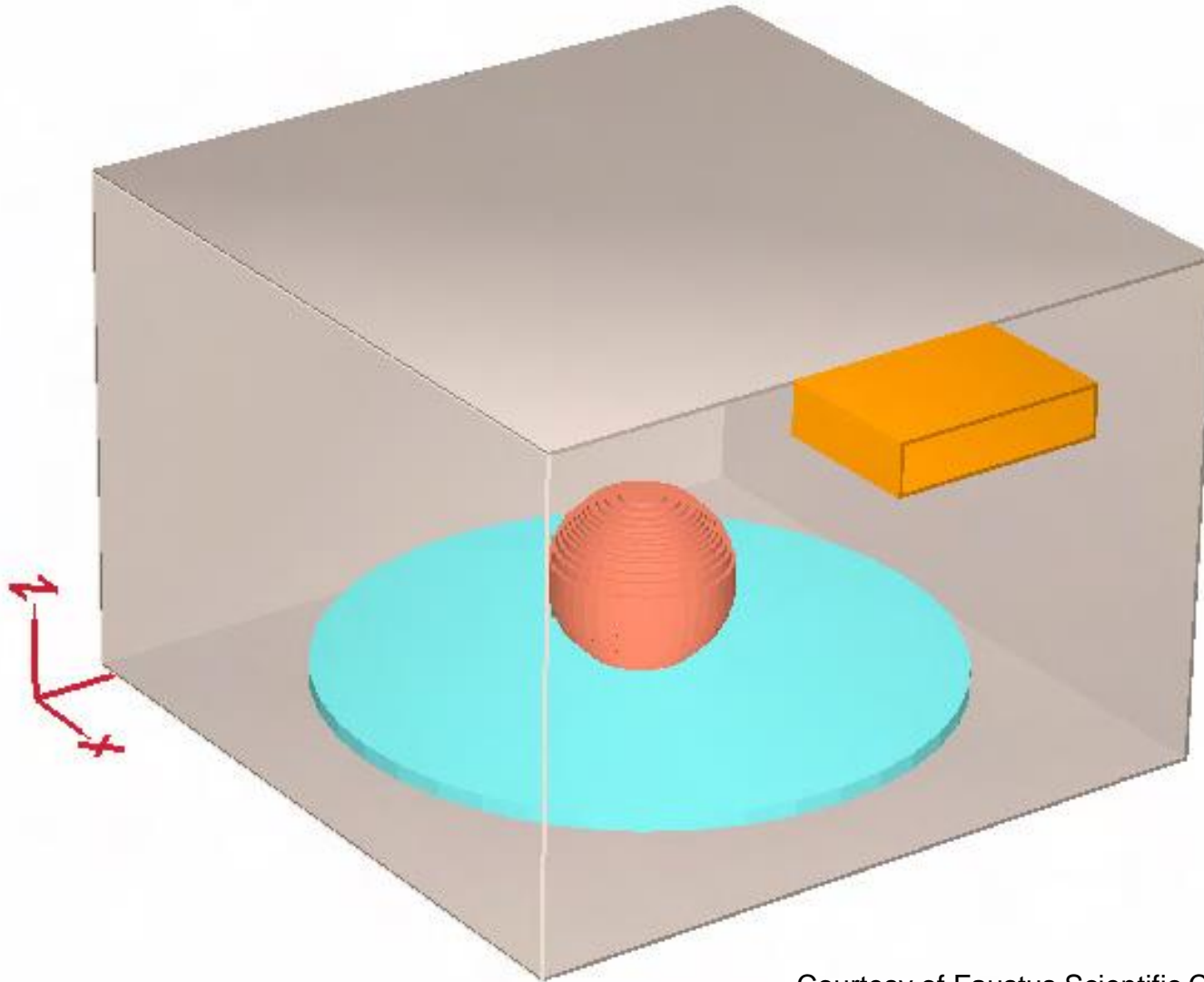

Courtesy of Faustus Scientific Corporation

# Dimensions

## Potato

Uniform lossy sphere

Diameter = 63 mm (2.5 in)

Volume = 131 cm<sup>3</sup>

(tennis ball size)

$\epsilon_r = 65 - j 20$

Density = 1 g/cm<sup>3</sup>

Mass = 131 g (4.6 oz)

Turntable: dielectric

$\epsilon_r = 2.55 - j 0$

Oven walls: PEC

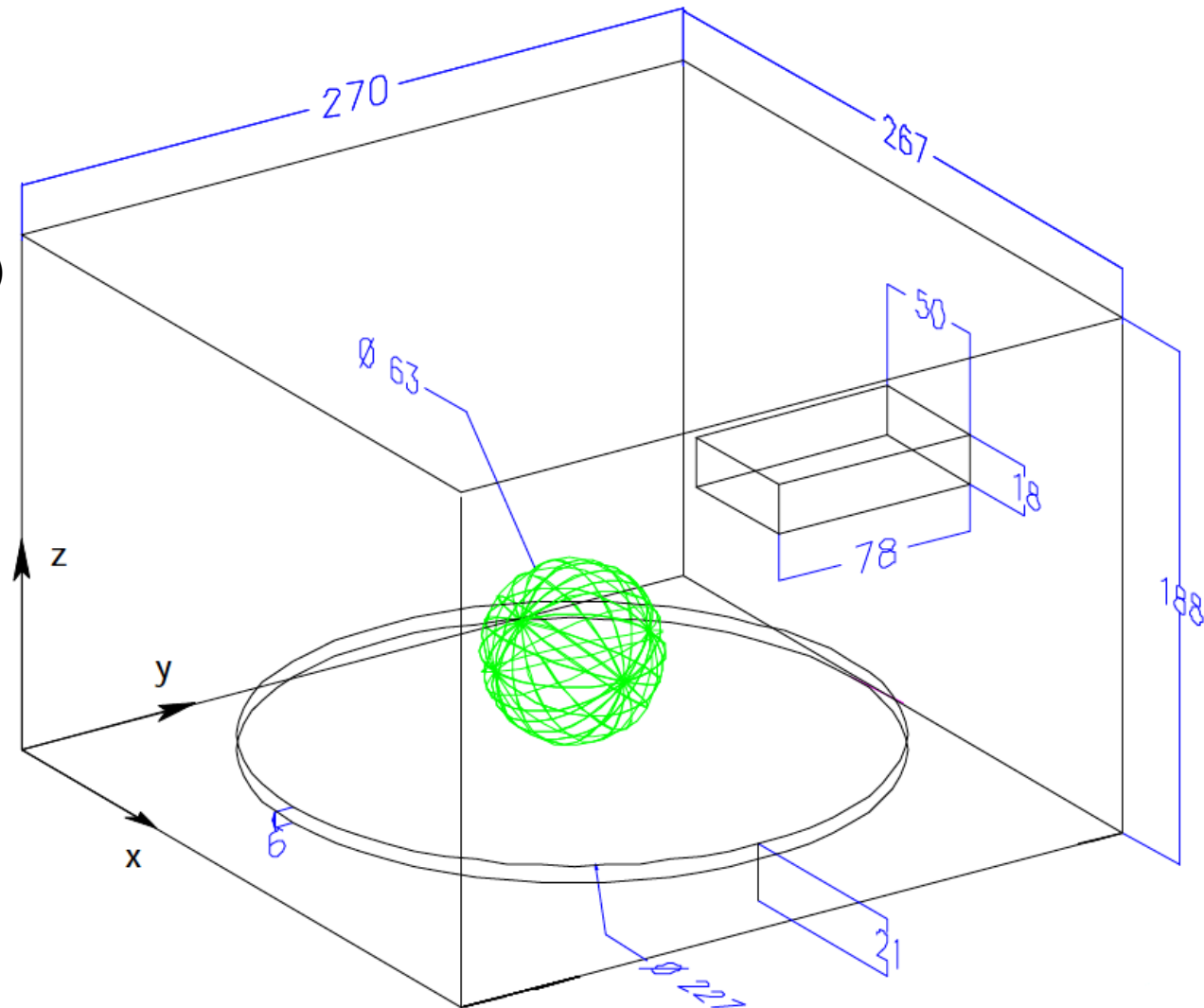

Courtesy of Faustus Scientific Corporation

# Electric Field $|E_z|$ inside Oven and Potato

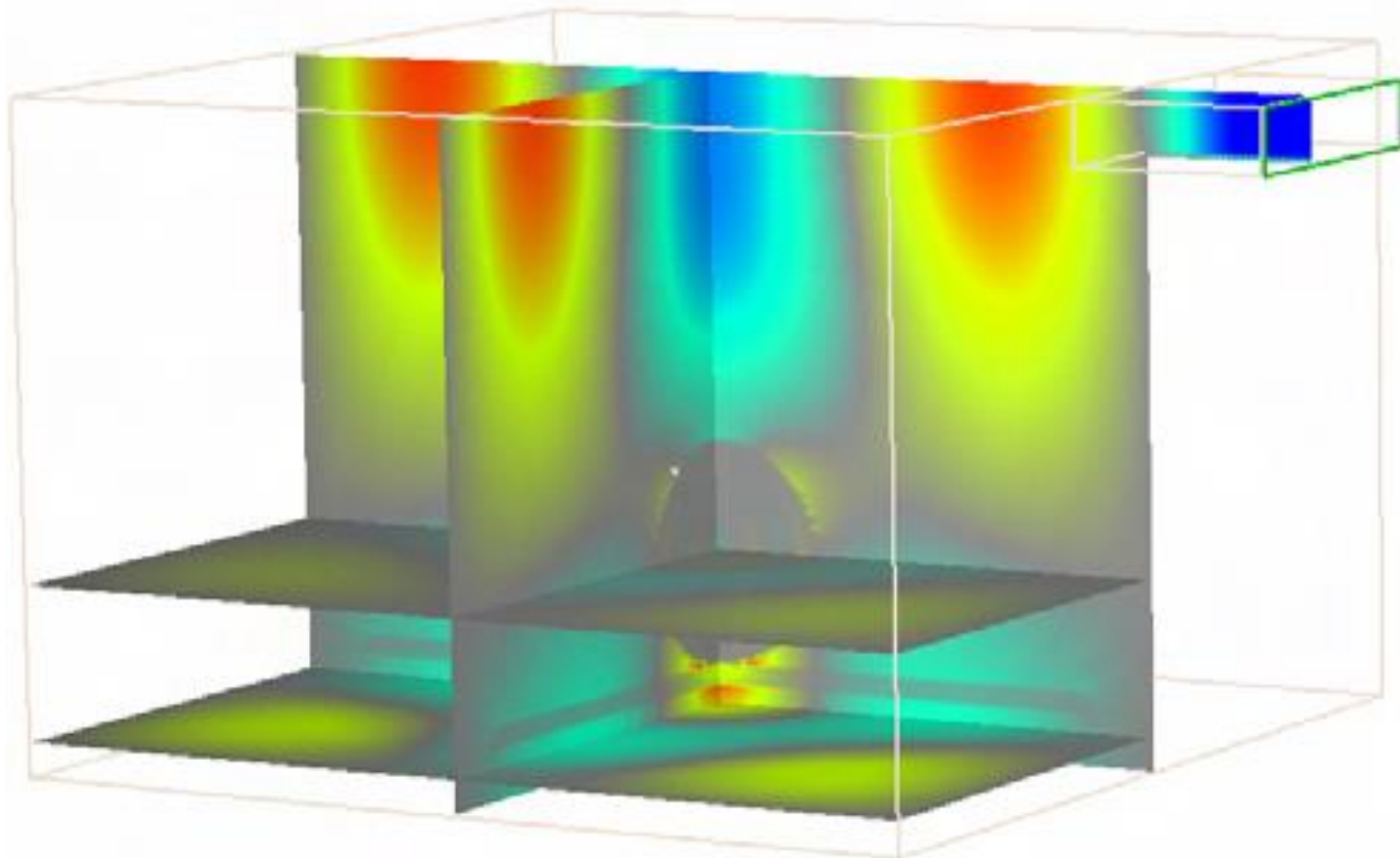

Courtesy of Faustus Scientific Corporation



# Magnitude of Electric Field $|E|$ inside Oven and Potato

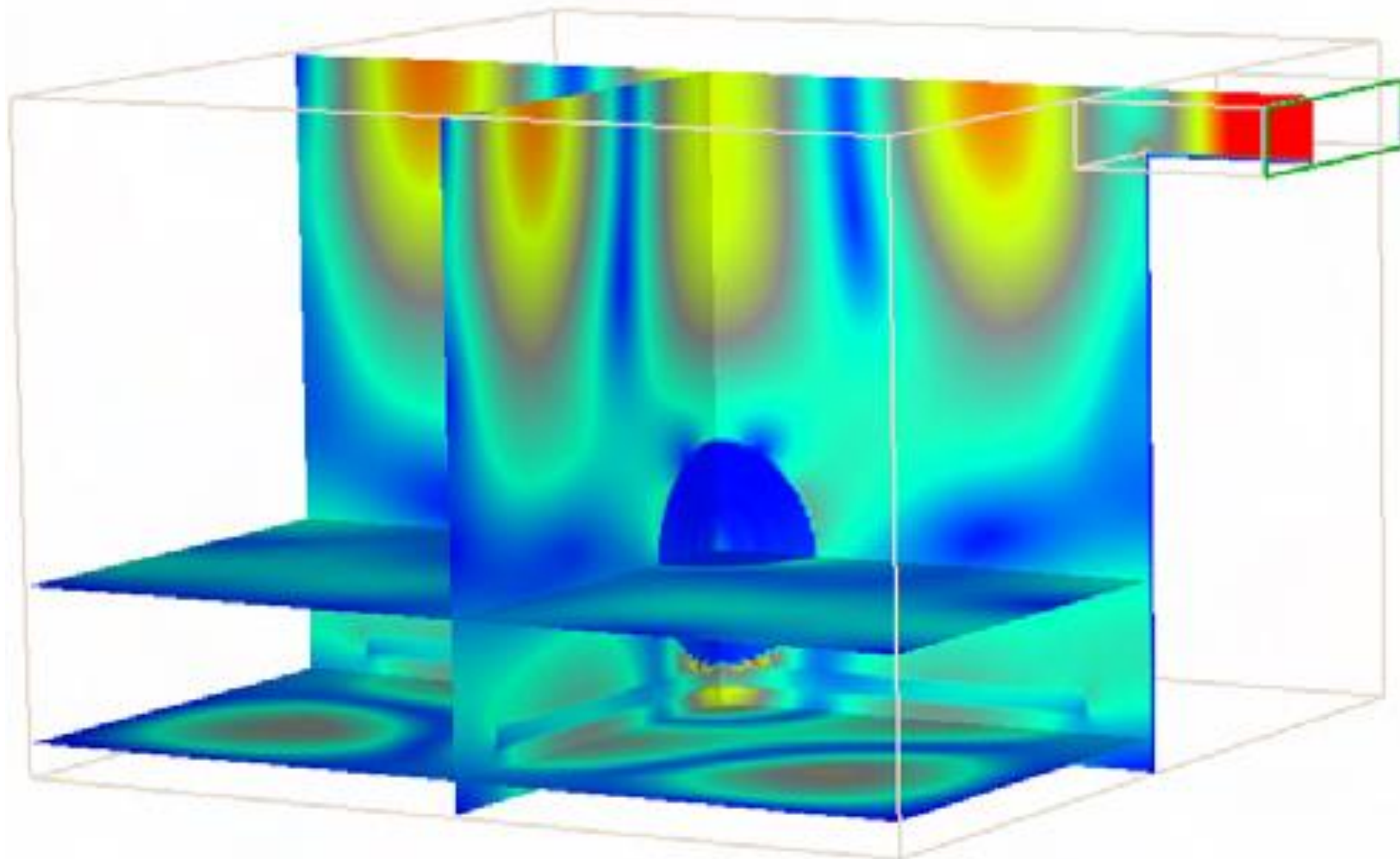

Courtesy of Faustus Scientific Corporation



# Electric Field Strength in Potato

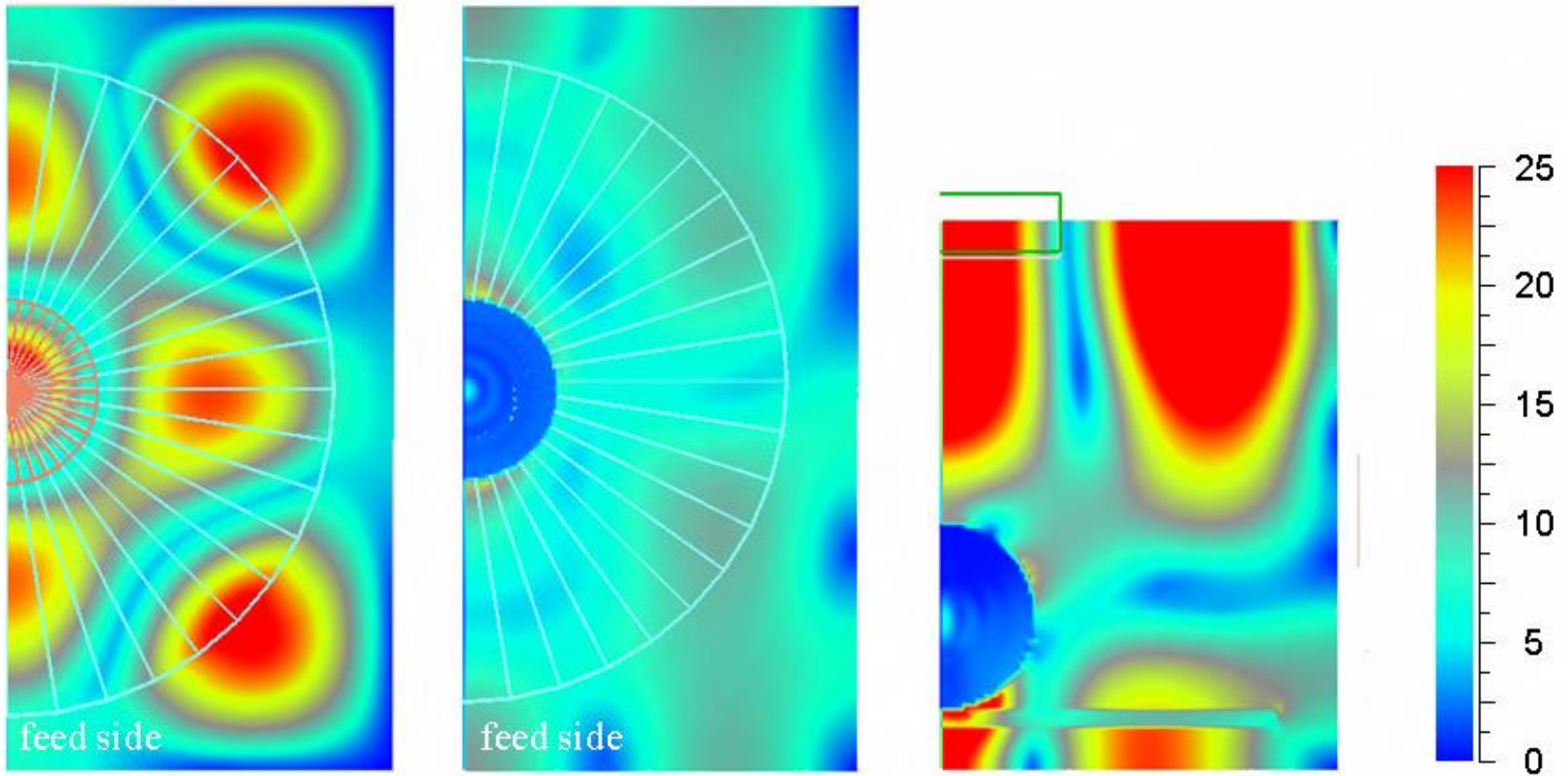

Courtesy of Faustus Scientific Corporation

# Specific Absorption Rate (SAR) of Potato

Potato cooks unevenly  
Bottom cooks faster than top  
Center hot spot due to focusing

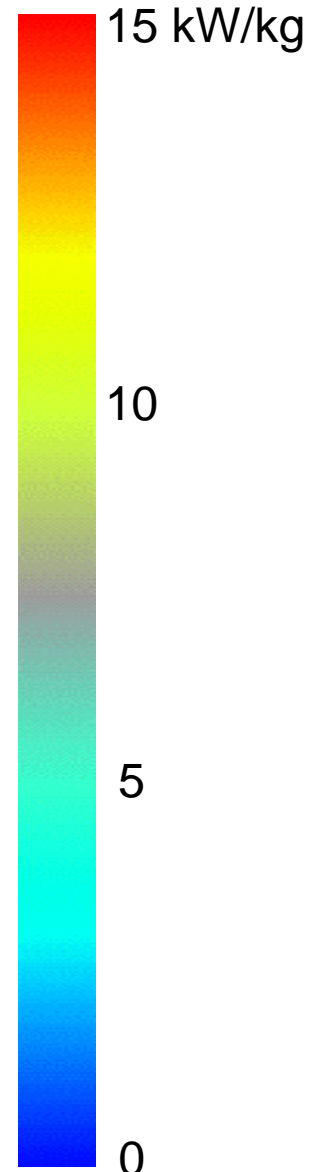
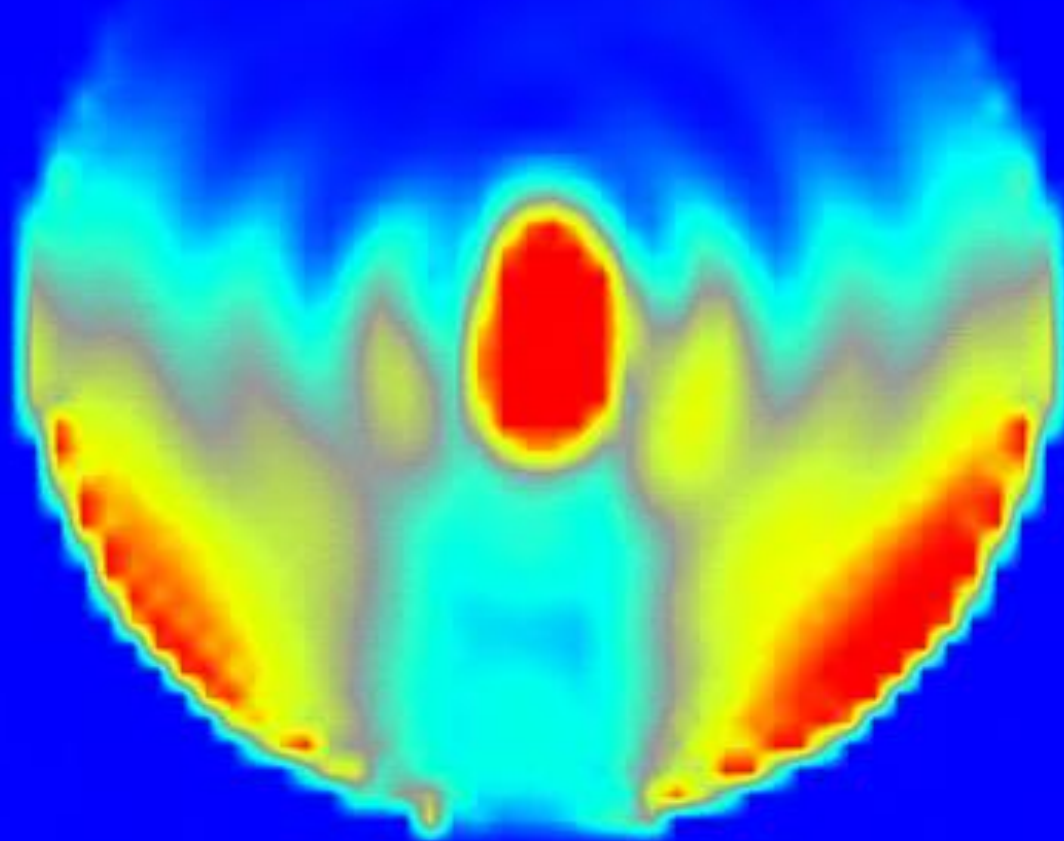

# Potato's SWR

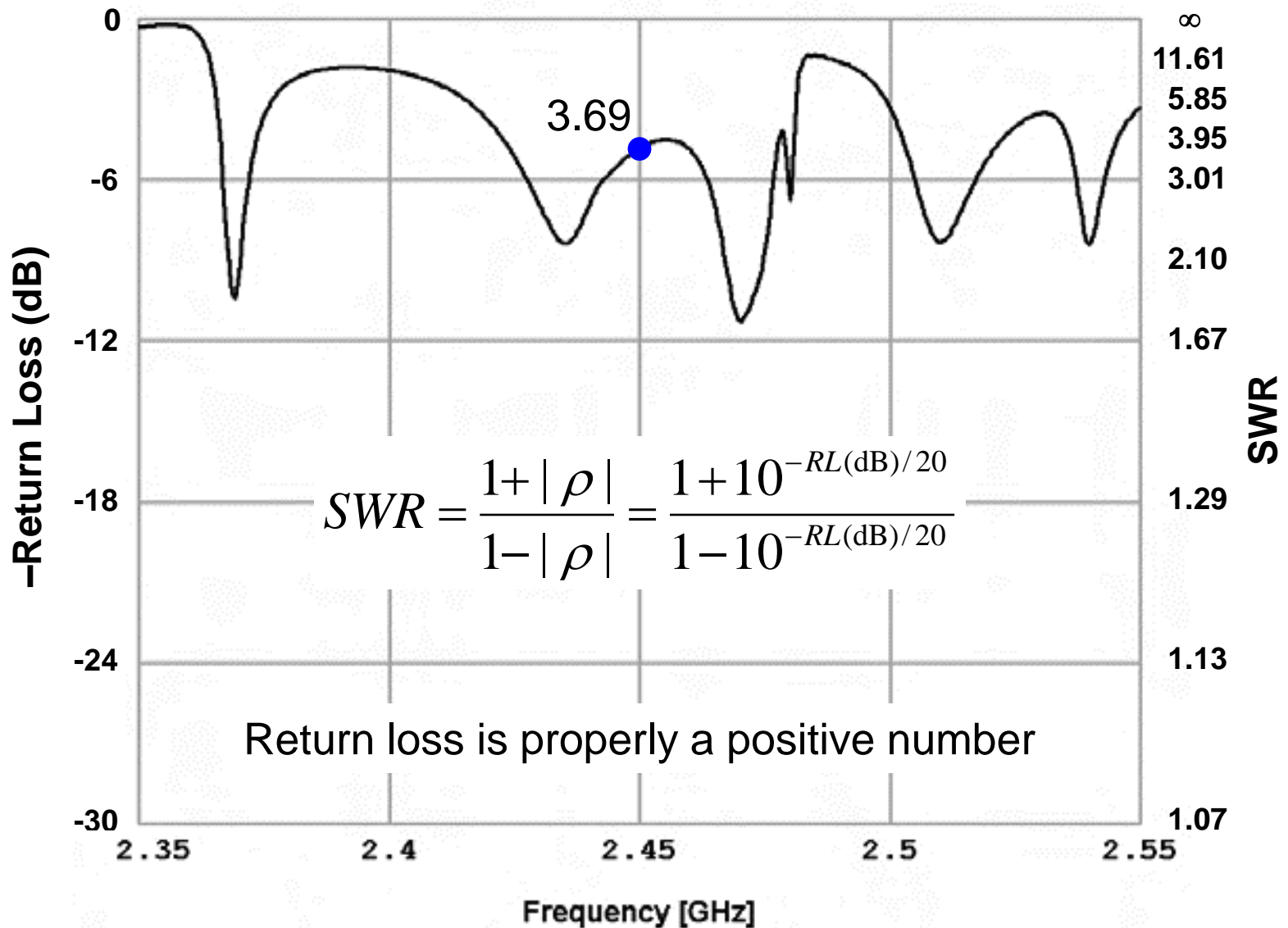

# Potato's SAR

- **RF parameters at 2.45 GHz (12.2 cm)**

- Return Loss = +4.83 dB
- SWR = 3.69
- $P_{incident} = 1000 \text{ W}$
- $P_{reflected} = 329 \text{ W (32.9\%)}$
- $P_{absorbed} = 671 \text{ W (67.1\%)}$

- **Specific Absorption Rate (SAR) of potato**

- $$SAR_{avg} = \frac{P_{absorbed}}{V_{potato} \times \rho_{potato}} = \frac{671 \text{ W}}{0.131 \text{ kg}} = 5,125 \text{ W/kg}$$

- **Potato SAR is 3,200 × the uncontrolled MPE limit!  
(but only for 6-8 minutes)**

- FCC uncontrolled MPE limit is 1.6 W/kg

# Mr. Potato Head



Courtesy of Hasbro

Questions for lawyers and philosophers: Is the RF exposure controlled or uncontrolled? Does it depend on whether the potato knows it is in the oven?

---

# **Fields in People**

**FEKO, WiPL-D and XFDTD**



# No – Fields in People! Not a Field of People

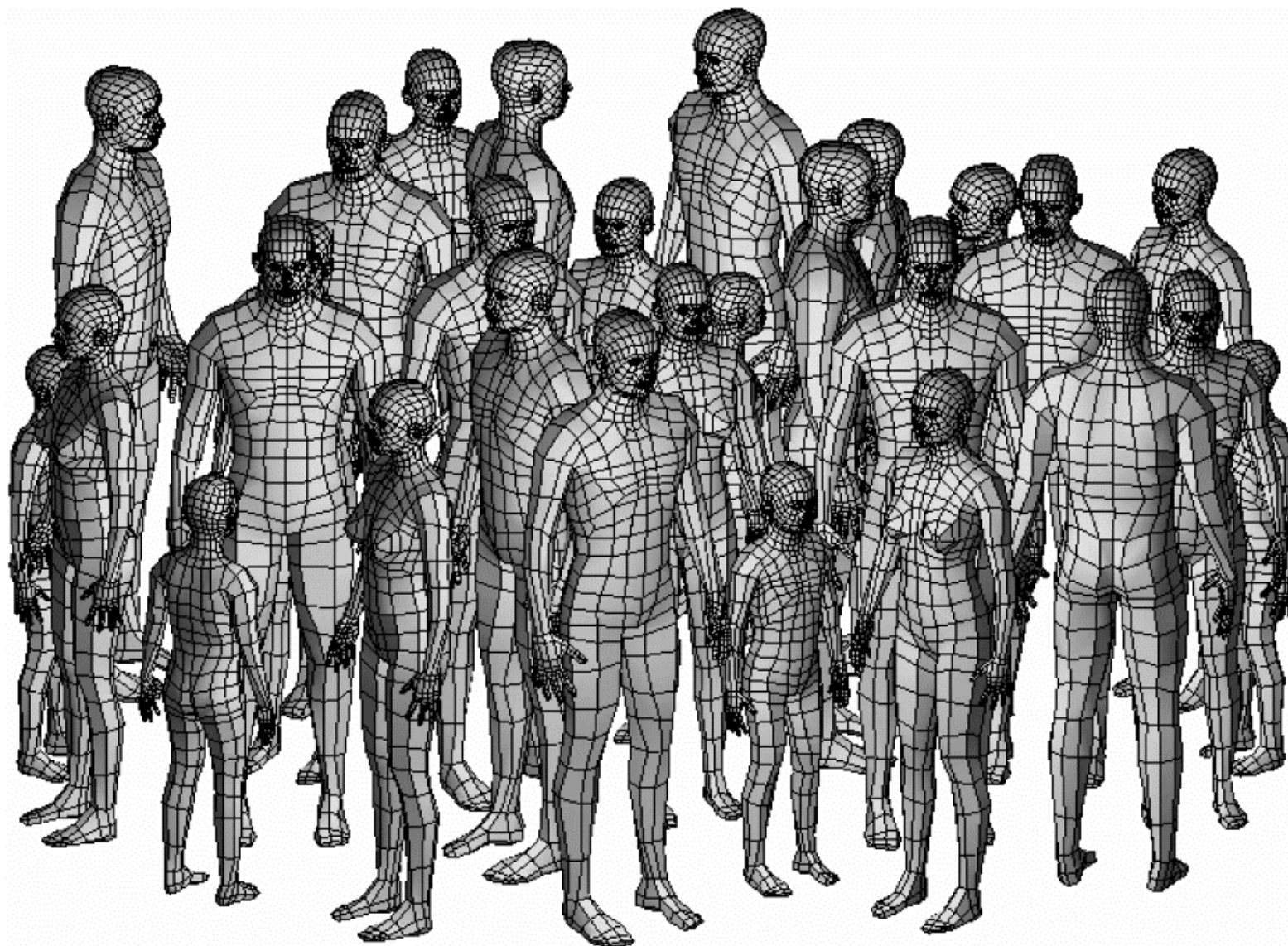



# No – Fields in People !

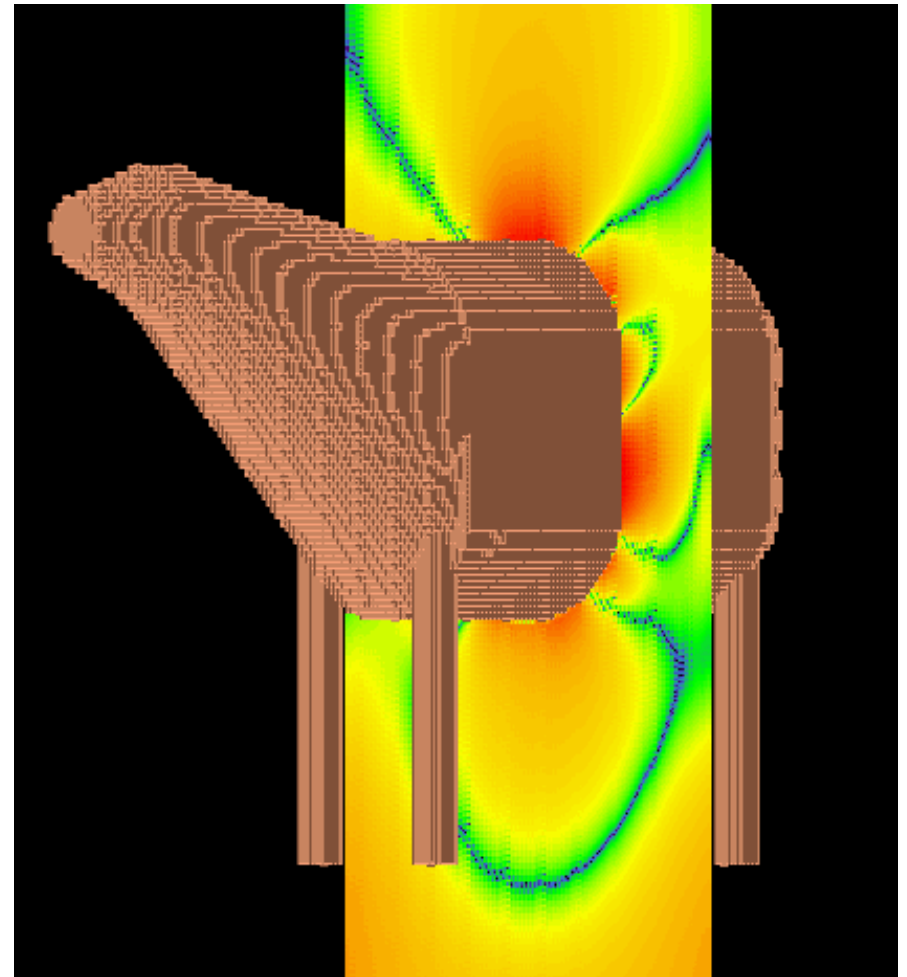
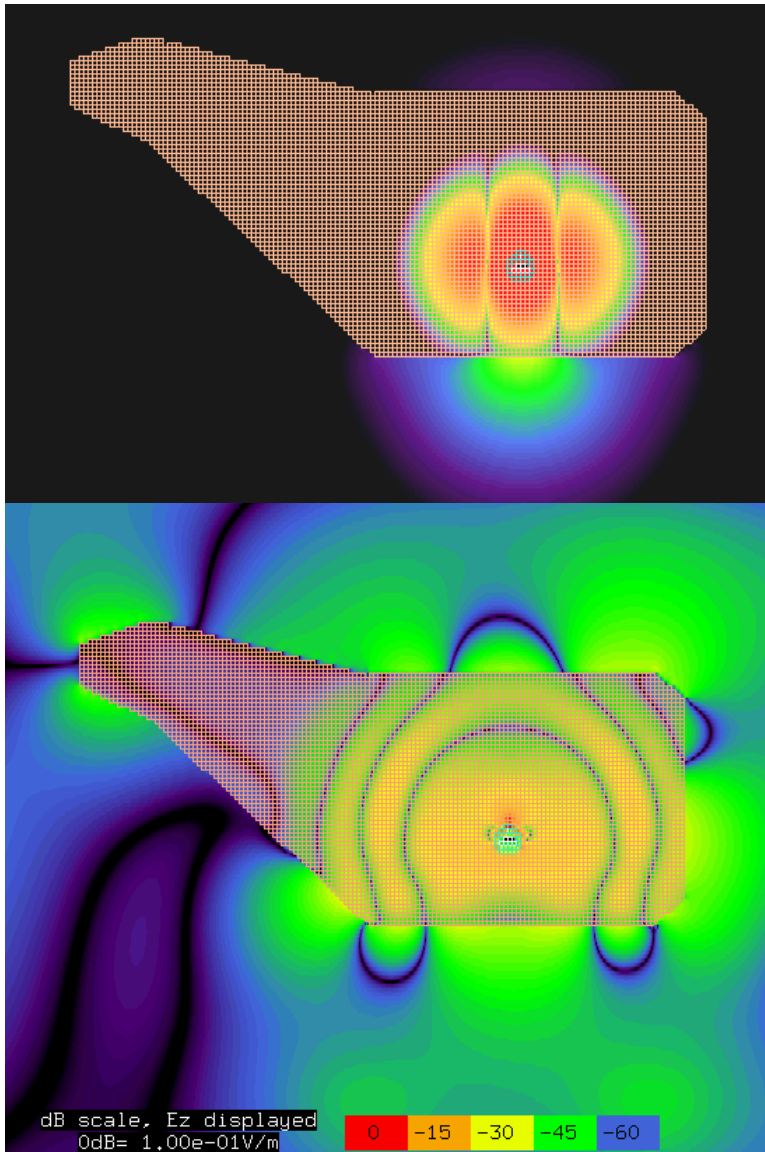

Transmitter Inside a Cow

# People Can Be Simple



	$\epsilon_r$	$\sigma$ S/m
Brain	43	1.5
Skull	15	0.6
Stuff	54	1.8

# People Can Be Complex

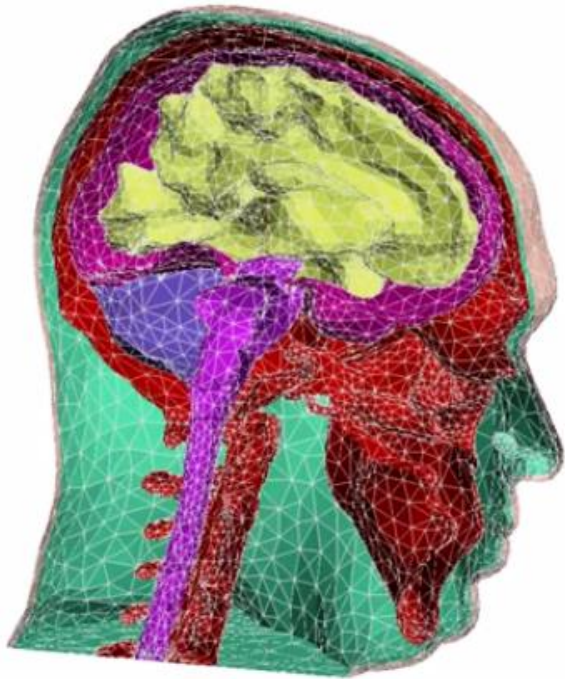

- **Male body phantom**

- 1 MHz to 20 GHz
- Tetrahedral size 12.3 mm
- 12 tissue types

- **Head phantom**

- Tetrahedral size 8.3 mm
- 8 tissue types



Courtesy of EMSS/Altair

# People Can Be Very Complex

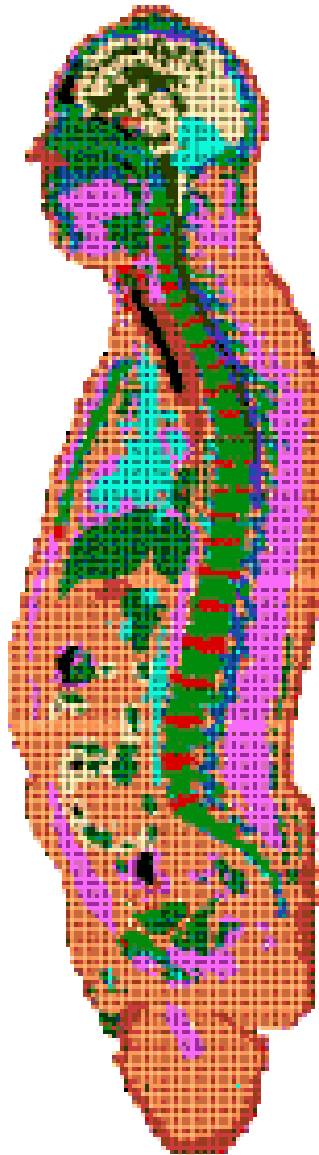

- **Male body phantom**
  - 1 MHz to 20 GHz
  - 4 million voxels (EM not biological)
  - 23 tissue types
- **Head phantom**
  - 8 million voxels
  - 17 tissue types

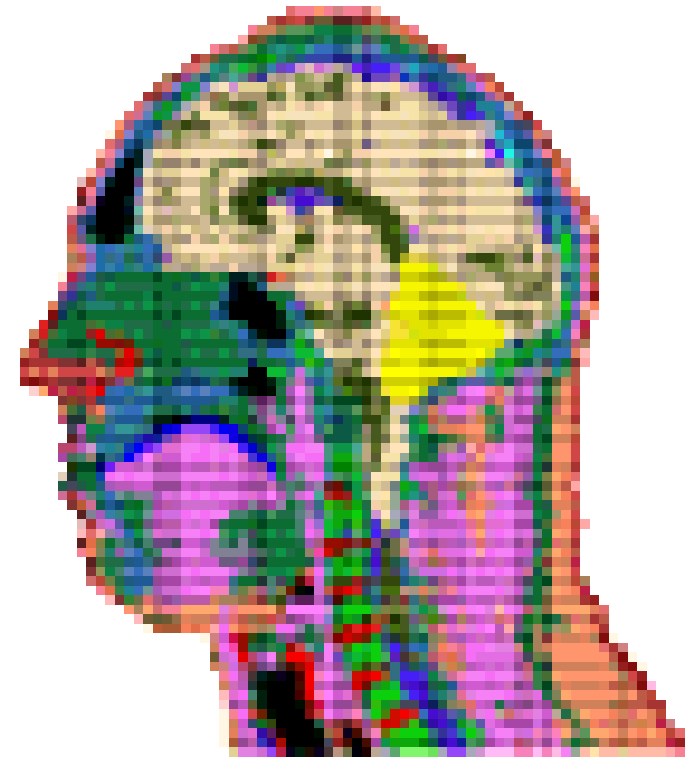

Courtesy of Remcom

# Tissue Parameters for Simple People

Frequency = 2,450 MHz

Tissue Type	$\epsilon_r$	$\sigma$ S/m	Density kg/m <sup>3</sup>
Average Brain	42.538925	1.511336	1030.0
Average Skull	14.965101	0.599694	1850.0
Average Muscle	53.573540	1.810395	1040.0

Source: FCC, Body Tissue Dielectric Parameters

<https://www.fcc.gov/general/body-tissue-dielectric-parameters>

# Tissue Parameters for Very Complex People

Tissue Type	$\epsilon_r$	$\sigma$
Bladder	18.000759	0.685294
Blood	58.263756	2.544997
Bone Cancellous	18.548979	0.805112
Bone Cortical	11.381223	0.394277
Bone Marrow Infiltrated	10.308158	0.458822
Bone Marrow Not Infiltr	5.296872	0.095031
Breast Fat	5.146670	0.137039
Cartilage	38.771160	1.755682
Cerebellum	44.803696	2.101270
Cerebro Spinal Fluid	66.243279	3.457850
Colon (Large Intestine)	53.878193	2.038204
Cornea	51.614494	2.295194
Dura	42.035004	1.668706
Eye Tissue (Sclera)	52.627628	2.033048
Fat	5.280096	0.104517
Fat (Mean)	10.820482	0.267954
Gall Bladder	57.633728	2.059032
Gall Blad Bile	68.360931	2.800733
Grey Matter	48.911255	1.807664
Heart	54.814018	2.256186
Kidney	52.742668	2.429709
Lens Cortex	44.625317	1.504036









Tissue Type	$\epsilon_r$	$\sigma$
Lens Nucleus	33.973507	1.086901
Liver	43.034443	1.686411
Lung (Inflated)	20.476801	0.804128
Lung (Deflated)	48.380974	1.682395
Muscle (Parallel Fiber)	54.417614	1.882011
Muscle (Transverse Fiber)	52.729469	1.738781
Nerve (Spinal chord)	30.145145	1.088474
Ovary	44.699692	2.263874
Skin (Dry)	38.006660	1.464073
Skin (Wet)	42.852562	1.591928
Small Intestine	54.424351	3.172779
Spleen	52.449310	2.238070
Stomach Esop Duodenum	62.158325	2.210518
Tendon	43.121975	1.684531
Testis Prostate	57.550518	2.167421
Thyroid Thymus	57.200367	1.967798
Tongue	52.627628	1.802514
Trachea	39.732574	1.448737
Uterus	57.813835	2.246464
Vitreous Humour	68.208023	2.478094
White Matter	36.166599	1.215008

Frequency = 2,450 MHz Source: FCC

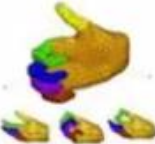

# Free People!

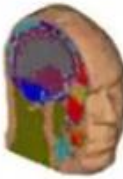
Download Free From [www.FEKO.info](http://www.FEKO.info)

Articulated (parametric) Human (SEP)	Standing Human (FEM)	Articulated Hand (SEP)	IEEE Head (SEP)	Visible Human Full Model (Inhomogeneous FEM)	Visible Human Head and Shoulders (Inhomogeneous FEM)	Visible Human Head (Inhomogeneous FEM)	IEEE SAM (Homogeneous FEM)	Hugo (4 Organs FEM)
Using geometry cards in EDITFEKO. Parametric i.e. change positions, sit, stand, raise arms, bend legs etc. The mesh size will change with frequency and has been tested up to 900 MHz.	Model is based on the Articulated Human. The model consists of 334,733 tetrahedrals (8mm size) and can be used for runs up to 1GHz. Requires more than 2 GByte of RAM.	Using geometry cards in EDITFEKO. Change position of fingers, 16 degrees of freedom. (Tested up to 1800 MHz)	This CADFEKO model is a triangle mesh of the inner layer of the IEEE SAM phantom. The minimum triangle length is 10mm. The model is set up for 1800 MHz. +- 2 GByte of RAM required.	The model contains 2.2 mil tetrahedrals (8mm size) and is suitable up to 1GHz. Requires a 64bit machine and will use +- 10 GByte of RAM.	The model contains 300,000 tetrahedrals (8mm size) and can be used up to 1 GHz. Can be solved on a 32bit machine with 2 GByte of RAM.	The model contains 900,000 tetrahedrals (4mm size) and can be used up to 2GHz. Requires a 64bit machine and will use more than 2 GByte of RAM.	5mm tetrahedral mesh of the older IEEE SAM phantom and a 20mm tetrahedral mesh air box around the head. The model is set up for 1800 MHz. Requires +- 1.4 GByte of RAM (with hertzian dipole as antenna (MoM)).	The model has 5 different media: brain, lungs, eyes, muscle and an outer air shell. The model contains 749,507 tetrahedrals (8mm size) and can be used up to 1GHz. Requires more than 2 GByte of RAM.
								

Courtesy of Altair



# Quadrilateral Surface Meshed Homogeneous Phantom

---



Courtesy of WiPL-D

# Introducing SAM Specific Anthropomorphic Mannequin

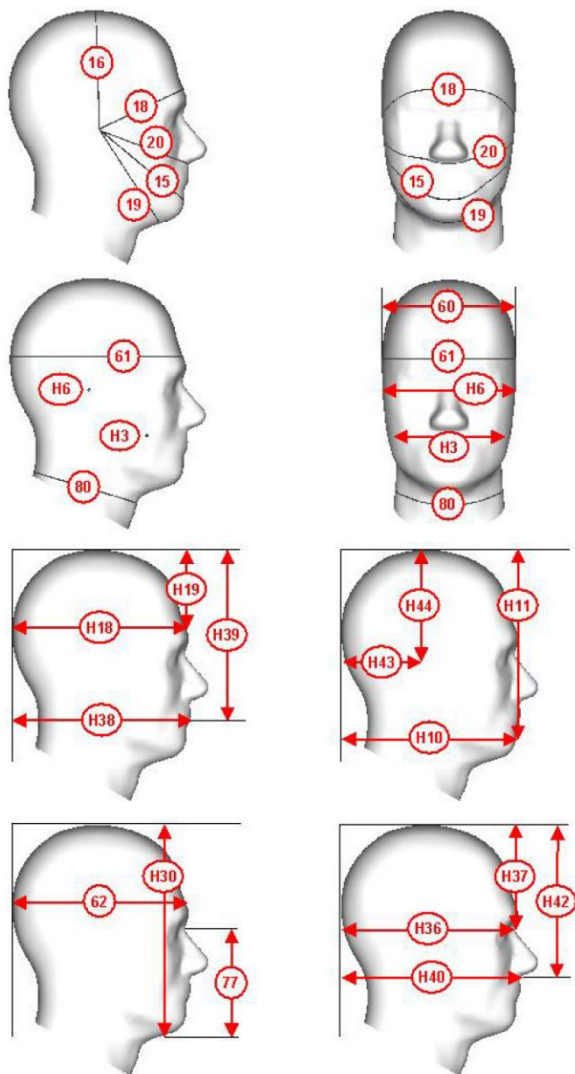

IEEE Standard 1528-2013

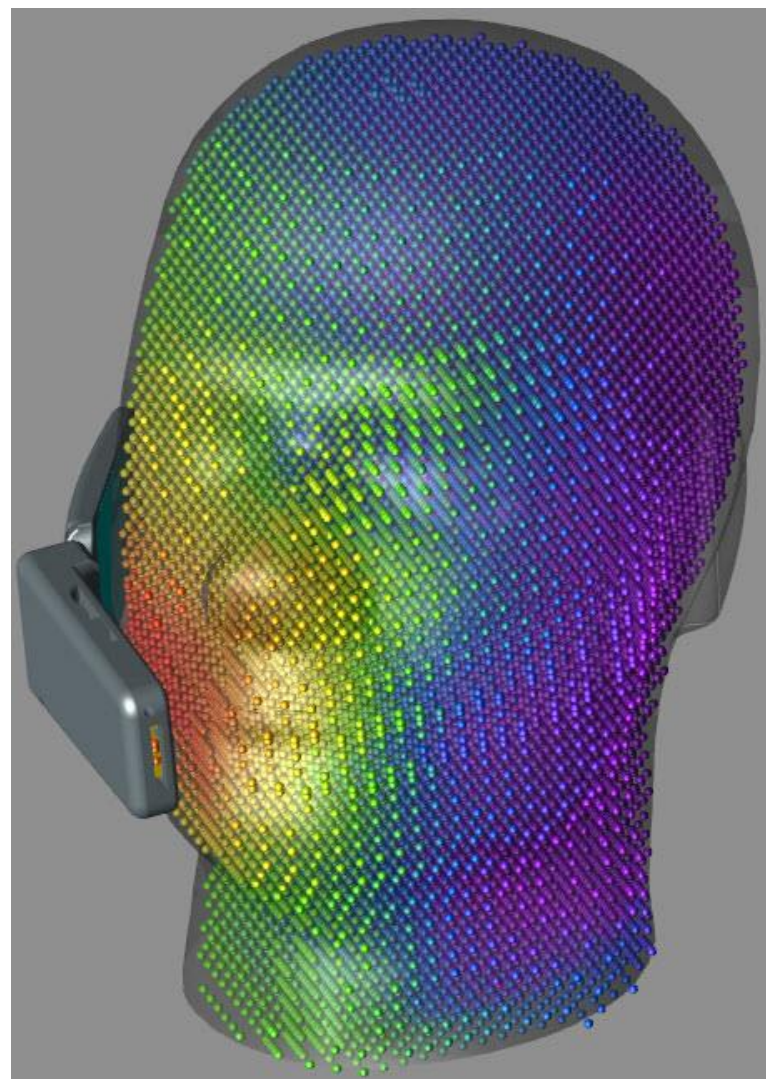

Courtesy of Remcom

# Field Strength and SAR in Phantom Head

abs(E) [V/m] X=0.03

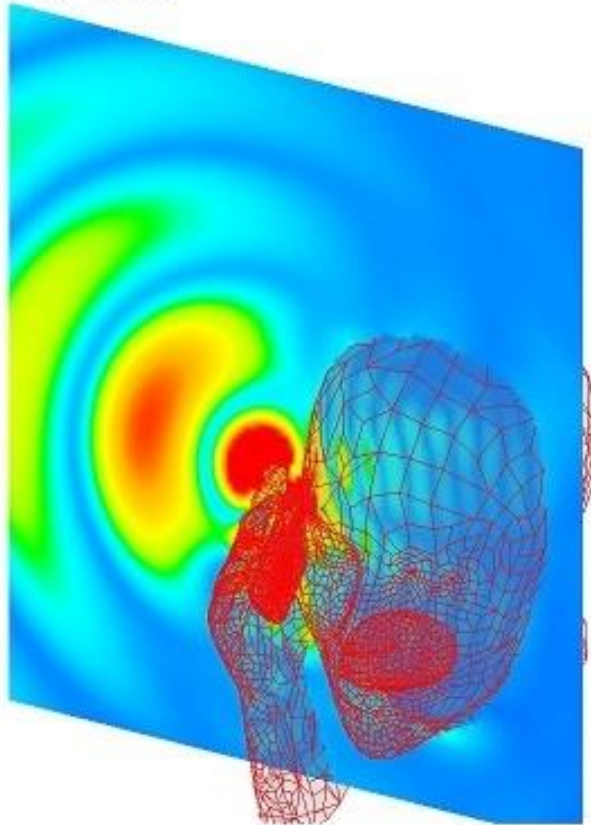
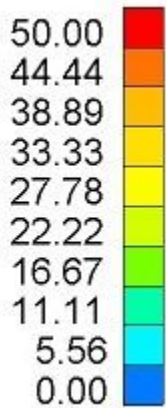

SAR [mW/m] X=0.02

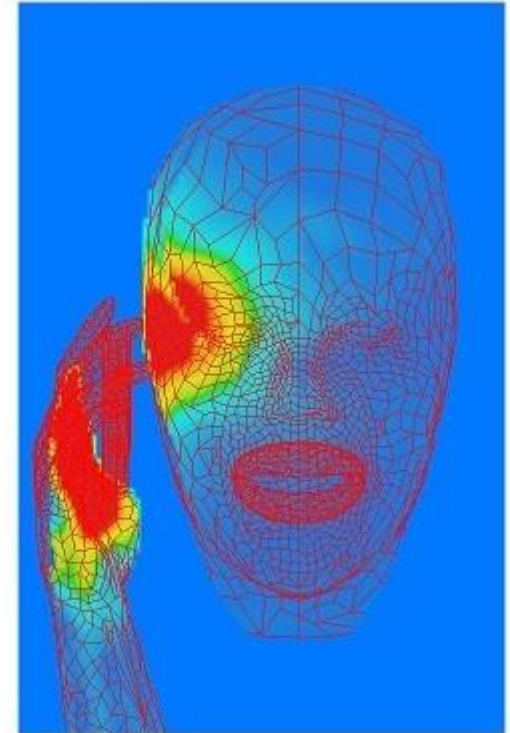
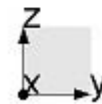
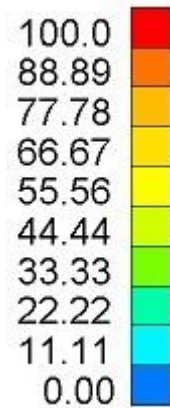

Courtesy of WiPL-D

- **Specific Absorption Rate (SAR)**
  - Units: watts/kilogram (W/kg)
- **Peak SAR (averaged over a gram) must not exceed**
  - Controlled exposure: 8.0 W/kg
  - Uncontrolled exposure: 1.6 W/kg

---

# Resources

# Antenna Modeling Programs for Radio Amateurs

- **EZNEC** <http://www.eznec.com>
  - EZNEC v.6 Demo program    Free (20 segments, also runs ARRL models)
  - EZNEC v.6                    \$100 (500 segments)
  - EZNEC+ v.6                 \$150 (2,000 segments)
  - EZNEC Pro/2 v.6            \$525 (45,000 segments)
  - EZNEC Pro/4 v.6            \$675 (sold only to NEC4 licensees)
- **4nec2** <http://www.qsl.net/4nec2>
  - Free, 11,000 segments, two optimizers, all NEC commands supported
- **MININEC** <http://www.w8io.com/mininec.htm> or <http://www.blackcatsystems.com/software>
  - Black Cat Systems offers MiniNEC Pro version 1.4.0, \$29
- **MMANA-GAL** <http://hamsoft.ca/pages/mmana-gal.php>
  - Free Basic version 8,192 segments. Pro version 32,000 segments, \$130
- **NEC4** <https://ipo.llnl.gov/technologies/nec>
  - Noncommercial user license \$300
- **FEKO Student Edition** <http://www.altairuniversity.com/feko-student-edition>
  - Free to students. Part of HyperWorks 2017 Student Edition
- **WiPL-D** <http://www.wipl-d.com>
  - Free “Microwave Lite” v6.0 (665 unknowns) and free 30-day trial of professional v13.0
- **HOBBIES** <http://www.em-hobbies.com>
  - Book includes software registration code, online price varies from \$125 to \$231 MSRP
- **CST Studio Suite Student Edition** <https://www.cst.com/academia/student-edition>
  - Free 3D basic version, 10,000 tet voxels, 9 example modeling files and tutorial videos
- **MEFiSTo** <http://www.faustcorp.com>
  - Free FDTD modeling code 2D basic version and free trial of 3D professional version
- **openEMS** <http://openems.de>
  - Free open-source FDTD modeling code that uses Matlab or Octave

# Accessory Software for EZNEC

---

- **AutoEZ 2.0.18 by Dan Maguire, AC6LA, <http://www.ac6la.com>**
  - Excel/Visual Basic program
    - Demo version, free (30 segment limit)
    - Regular version, \$79
  - Requires Excel and EZNEC installed on computer
  - Controls EZNEC to make multiple runs
    - It's a GUI for a GUI for NEC
  - Optimizer – Nelder-Mead algorithm
  - Reads NEC, AO, and MMANA-GAL files
  - Doesn't work with EZNEC-ARRL or EZNEC Demo
  - Replaces MultiNEC, which is no longer available
  - Highly recommended for EZNEC users



# HOBBIES

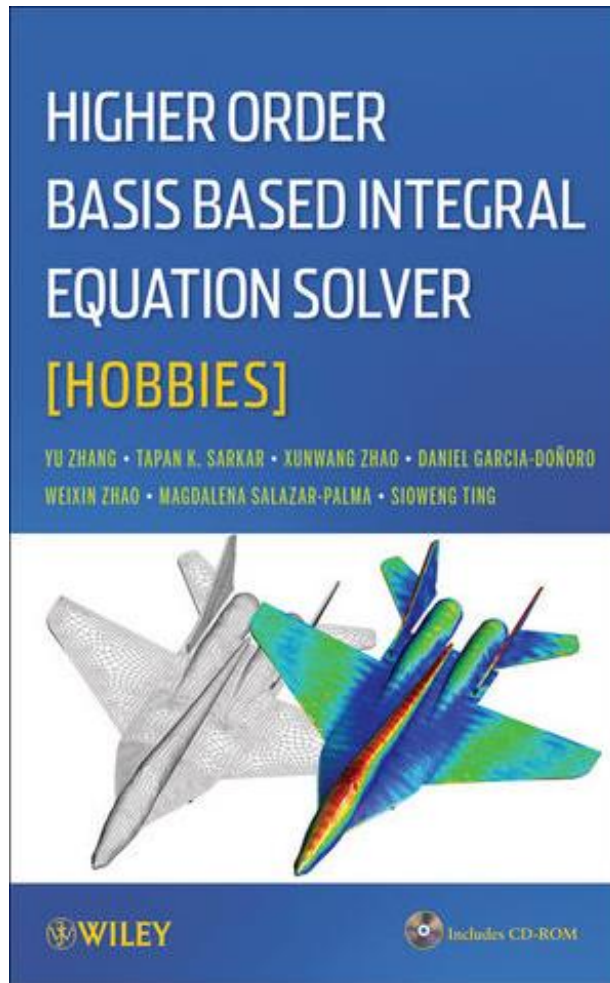

- <http://www.em-hobbies.com>
- Y. Zhang, et al., *Higher Order Basis Based Integral Equation Solver (HOBBIES)*, Wiley, 2012, ISBN 9781118140659
- Make sure to buy a new copy with software license registration code intact and unused



# Favorite Antenna Books

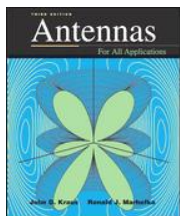
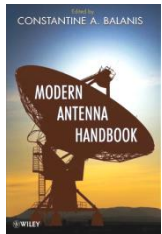
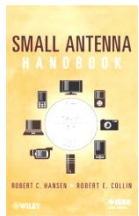
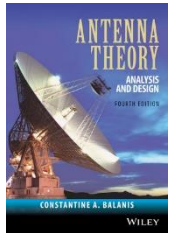

## ■ Books for antenna engineers and students

- C.A. Balanis, *Antenna Theory: Analysis and Design*, 4e, Wiley, 2016
- R.C. Hansen and R.E. Collin, *Small Antenna Handbook*, Wiley, 2011
- C.A. Balanis, ed., *Modern Antenna Handbook*, Wiley, 2008
- J.L. Volakis, ed., *Antenna Engineering Handbook*, 4e, McGraw-Hill, 2007
- J.D. Kraus and R.J. Marhefka, *Antennas*, 3e, McGraw-Hill, 2001

## ■ Free downloadable books – partial list on next slide

## ■ Antenna research papers

- IEEE Xplore subscription online archive, <https://ieeexplore.ieee.org/Xplore/home.jsp>
- IEEE AP-S Digital Archive, 2001-2009 (1 DVD), JD0307
- IEEE AP-S Digital Archive, 2001-2006 (1 DVD), JD0304
- IEEE AP-S Digital Archive, 2001-2003 (1 DVD), JD0301
- IEEE AP-S Digital Archive, 1952-2000 (2 DVDs), JD0351
- Allerton Antenna Applications Symposium DVD archive 1952-2018

## ■ ACES Journal Archives

- <http://www.aces-society.org/journal.php>

# Free Downloadable Books – A Very Small List

- S.J. Orfanidis, *Electromagnetic Waves and Antennas*, Rutgers U., 2016
  - <http://www.ece.rutgers.edu/~orfanidi/ewa>
- D.M. Pozar, *Microwave Engineering*, 4e, Wiley, 2012
  - <http://exam-fever.com/ExamFever/rfmwetb.pdf>
- P-S. Kildal, *Foundations of Antenna Engineering*, 2015
  - <http://kildal.se/index.php/news-page/28-book>
- C.A. Balanis, *Antenna Theory: Analysis and Design*, 3e, Wiley, 2005
  - <https://archive.org/details/Antenna.Theory.Analysis.and.Design3rd.Edition>
- J. Layton, *Directional Broadcast Antennas: A Guide to Adjustment...*, TAB Books, 1974
  - <http://www.americanradiohistory.com/Archive.../Directional-Broadcast-Antennas-Leyton.pdf>
- A.D. Watt, *VLF Radio Engineering*, Pergamon Press, 1967
  - <http://www.introni.it/pdf/Watt%20-%20VLF%20Radio%20Engineering%2014.pdf>
- G.Z. Ayzenberg, *Shortwave Antennas*, revised edition, translated from Russian, 1962
  - <http://www.dtic.mil/docs/citations/AD0706545>
- S. Seely, *Radio Electronics*, McGraw-Hill, 1956
  - <https://archive.org/details/RadioElectronics>
- S.A. Schelkunoff and H.T. Friis, *Antennas: Theory and Practice*, Wiley, 1952
  - <https://archive.org/details/antennastheorypr00sche>
- E.A. Laport, *Radio Antenna Engineering*, McGraw-Hill, 1952
  - <http://snulbug.mtview.ca.us/books/RadioAntennaEngineering>
- K. Henney, *Radio Engineering Handbook*, McGraw-Hill, 1950
  - <https://archive.org/details/radioengineering00henn>
- F. Langford-Smith, *The Radiotron Designers Handbook*, Wireless Press, 1941
  - <https://archive.org/details/radiotrongdesigne00lang>
- K. Henney, *Principles of Radio*, Wiley, 1934
  - <https://archive.org/details/principlesofradi00henn>

# Favorite Antenna Books continued

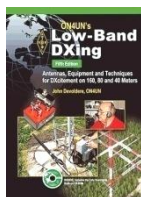
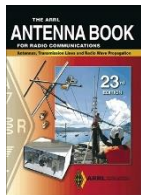

## Books for Radio Amateurs

- H.W. Silver, N0AX, ed., *ARRL Antenna Book*, 23e, ARRL, 2015
- A. Krischke, DJ0TR, ed., *Rothammel's Antennenbuch*, 13e, DARC, 2013
- J. Devoldere, ON4UN, *ON4UN's Low-Band Dxing*, 5e, ARRL, 2011
- I. Poole, G3YWX, ed., *Practical Wire Antennas 2*, RSGB, 2005
- J. Sevick, W2FMI, *The Short Vertical Antenna and Ground Radial*, CQ, 2003
- L. Moxon, G6XN, *HF Antennas for All Locations*, 2e, RSGB, 1983
- J.L. Lawson, W2PV, *Yagi Antenna Design*, ARRL, 1986

## ARRL Antenna Compendium series – eight volumes

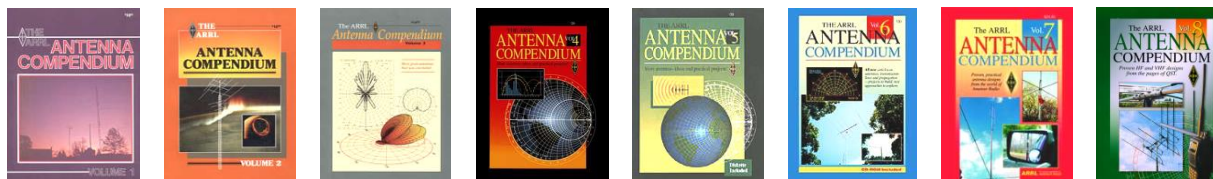

## ARRL Antenna Classics series – eight titles

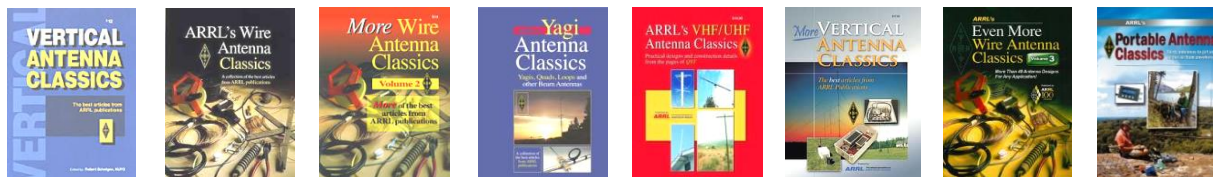

# Recent Antenna Books of Interest

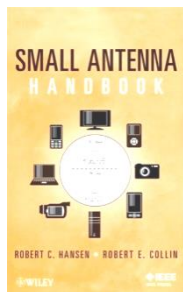

R.C. Hansen and R.E. Collin, *Small Antenna Handbook*, Wiley, 2011

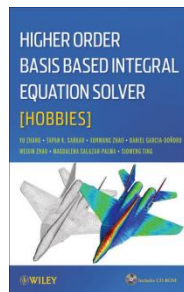

Y. Zhang et al., *Higher Order Basis Based Integral Equation Solver (HOBBIES)*, Wiley, 2012

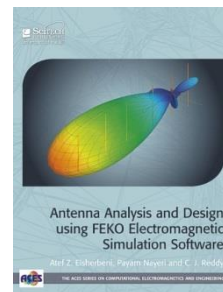

Elsherbeni, et al., *Antenna Analysis and Design using FEKO...*, SciTech / IET, 2014

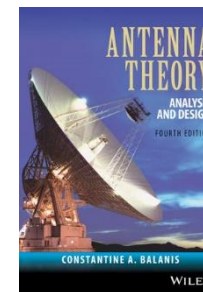

C.A. Balanis, *Antenna Theory: Analysis and Design*, 4e, Wiley, 2016

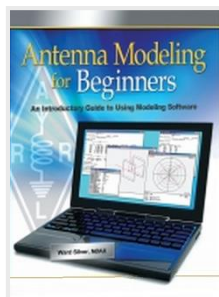

H.W. Silver, N0AX, *Antenna Modeling for Beginners*, ARRL, 2012

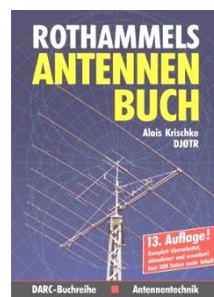

A. Krischke, DJ0TR, ed., *Rothammels Antennen Buch*, 13e, DARC, 2013

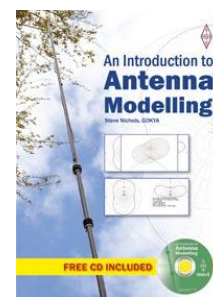

S. Nichols G0KYA, *An Introduction to Antenna Modelling*, RSGB, 2014

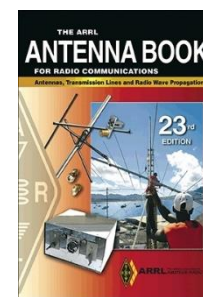

H.W. Silver, N0AX, ed., *ARRL Antenna Book*, 23e, ARRL, 2015



# Four Good History Reads

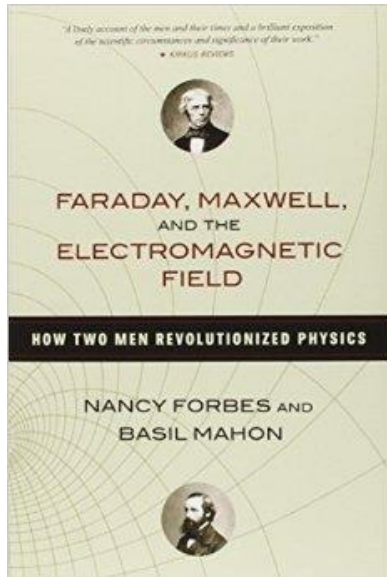

**Nancy Forbes and Basil Mahon, *Faraday, Maxwell, and the Electromagnetic Field*, Prometheus, 2014**

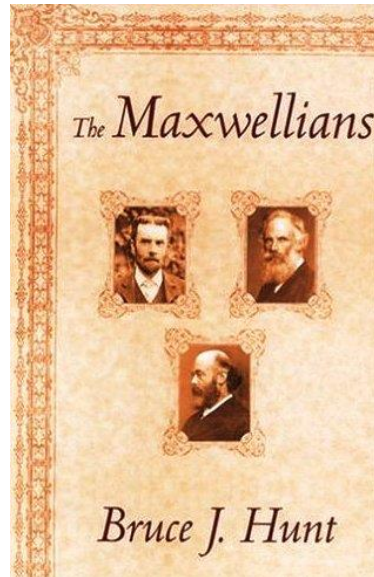

**Bruce J. Hunt, *The Maxwellians*, Cornell University Press, 1991**

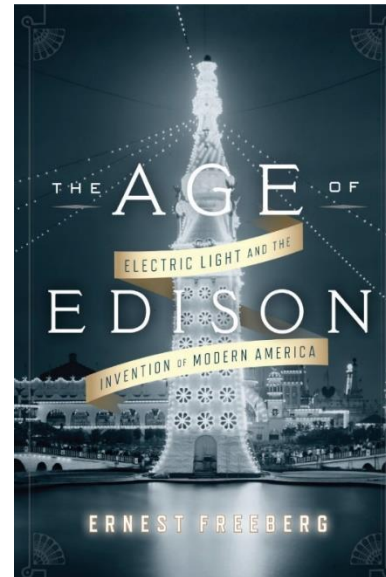

**Ernest Freeberg, *The Age of Edison*, Penguin Books, 2014**

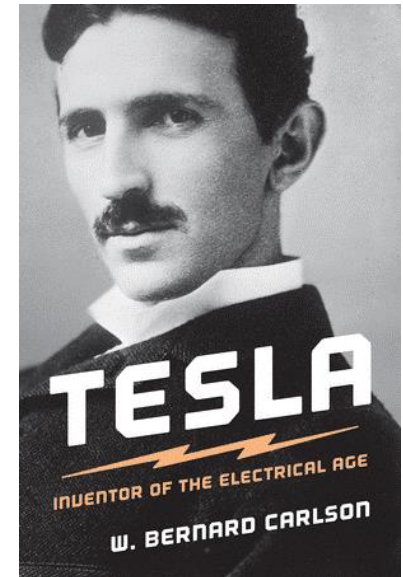

**W. Bernard Carlson, *Tesla: Inventor of the Electrical Age*, Princeton University Press, 2015**

---

# The End

This presentation will be archived at  
<http://www.fars.k6ya.org/others>