

---

# Dipole Basics

**Steve Stearns, K6OIK**

**Consulting Engineer**

[stearns@ieee.org](mailto:stearns@ieee.org)  
[k6oik@arrl.net](mailto:k6oik@arrl.net)

# Abstract

---

The dipole is the most basic of antennas. A proper understanding of dipole properties and characteristics is essential to understanding many other antennas including complementary antennas such as slots. In this tutorial, Steve Stearns, K6OIK, explains the basic characteristics of dipoles for transmitting and receiving. Some surprises await as we learn that a dipole's transmit current distribution is not exactly sinusoidal, and the receive distribution can be entirely different. Steve will explain the physics of the much misunderstood dipole shortening factor  $K$ , and why a dipole's effective receiving capture area is different from its physical cross-sectional area, and that resonance is a poor indicator of match. Steve will indicate which dipole properties are better determined from graphs and equations, and which other properties are better determined by numerical computation, known as modeling.

# Sunday

A Marconi, not a Hertz, antenna

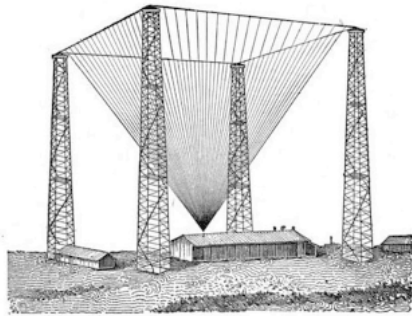

## Antenna Modeling Seminar Sunday - 1/2 Day

**8:00 AM - 12:00 PM**

**Contra Costa Salon 2**

Steve Stearns, K6OIK, will present Pacificon's first ever 1/2 day seminar on the software modeling of antennas.

Topics will include:

- Antenna modeling,
- Software tools,
- Specifying a model,
- Calculating far field patterns,
- Calculating near fields,
- Calculating impedance,
- Using E&M optimizers to find the best geometry,
- How to export and transfer impedance data between programs,
- Impedance match network design,
- Using circuit optimizers to find the best design.

### Steve Stearns, K6OIK

Steve started in ham radio while in high school at the height of the Heathkit era. He holds FCC Amateur Extra and a commercial General Radio Operator license with Radar endorsement. He previously held Novice, Technician, and 1<sup>st</sup> Class Radiotelephone licenses. He studied electrical engineering at California State University Fullerton, the University of Southern California, and Stanford, specializing in electromagnetics, communication engineering and signal processing. Steve was Senior Vice President of Research at VStar Systems Inc., where he led the development of advanced antennas and algorithms for communication signal processing for reception, radio direction finding, and geo-locating systems. He was previously Technical Fellow at Northrop Grumman Corporation's Electromagnetic Systems Laboratory in San Jose, California. Steve is serving as vice-president of the Foothills Amateur Radio Society, and served previously as assistant director of ARRL Pacific Division. He has over 100 professional publications and presentations and ten patents. Steve has received numerous awards for professional and community volunteer activities.

[The above image is a drawing of Guglielmo Marconi's wireless telegraphy transmitting station in Poldhu, Cornwall, erected October 1901, with which he transmitted the first transatlantic radio message to St. John's Bay, Newfoundland on 12 December 1901, a distance of 2300 mi (3500 km), (although there is some doubt Marconi actually received this transmission). See [https://commons.wikimedia.org/wiki/File:Drawing\\_of\\_Marconi\\_Poldhu\\_wireless\\_station\\_1901.png](https://commons.wikimedia.org/wiki/File:Drawing_of_Marconi_Poldhu_wireless_station_1901.png) for details.]

# Speaker's Biography



- **Stephen D. Stearns**
- **Senior VP of Research, VStar Systems Inc.**
- **40 years experience in electronic systems**
  - Northrop Grumman, TRW, GTE Sylvania, Hughes Aircraft
  - Electromagnetic and signal processing systems for communications and radar surveillance, cochannel signal separation, measurement, identification, characterization, polarimetric array signal processing of ionospheric skywave signals for precision geolocating HF emitters, sensor fusion
  - Recent work: Antenna and scattering theory; Non-Foster circuits for antennas and metamaterials; antennas to radiate OAM Bessel-Vortex beams; double-reflectionless harmonic reject filters
- **FCC licenses**
  - Amateur Radio Extra Class
  - 1<sup>st</sup>-Class Radiotelephone
  - General Radio Operator License (GROL)
  - Ship Radar Endorsement
- **Education**
  - PhD Stanford – under Prof. T.M. Cover
  - MSEE USC – under Profs. H.H. Kuehl and C.L. Weber
  - BSEE CSUF – under Profs. J.E. Kemmerly and G.I. Cohn
- **10 patents**
- **More than 100 publications and presentations, both professional (IEEE) and hobbyist (Amateur Radio)**

# ARRL Pacificon Presentations by K6OIK

Archived at  
<http://www.fars.k6ya.org>

1999	Mysteries of the Smith Chart	
2000	Jam-Resistant Repeater Technology	
2001	Mysteries of the Smith Chart	✓
2002	How-to-Make Better RFI Filters Using Stubs	
2003	Twin-Lead J-Pole Design	
2004	Antenna Impedance Models – Old and New	✓
2005	Novel and Strange Ideas in Antennas and Impedance Matching	
2006	Novel and Strange Ideas in Antennas and Impedance Matching II	✓
2007	New Results on Antenna Impedance Models and Matching	✓
2008	Antenna Modeling for Radio Amateurs	
2010	Facts About SWR, Reflected Power, and Power Transfer on Real Transmission Lines with Loss	✓
2011	Conjugate Match Myths	✓
2012	Transmission Line Filters Beyond Stubs and Traps	✓
2013	Bode, Chu, Fano, Wheeler – Antenna Q and Match Bandwidth	✓
2014	A Transmission Line Power Paradox and Its Resolution	✓
2015	Weird Waves: Exotic Electromagnetic Phenomena	✓
2015	The Joy of Matching: How to Design Multi-Band Match Networks	✓
2016	The Joy of Matching 2: Multi-Band and Reflectionless Match Networks	
2016-7	Antenna Modeling for Radio Amateurs – Revised and Expanded	✓
2017	VHF-UHF Propagation Planning for Amateur Radio Repeaters	✓
2018	Antennas: The Story from Physics to Computational Electromagnetics	
2018	Novel Antennas, The Mysterious Factor $K$ , Impromptu Antenna Modeling	
2019	Dipole Basics	
2019	Antenna Modeling Half-day Seminar	

# Questions for 2019

---

- Q1: What was Einstein's explanation of how radio works?

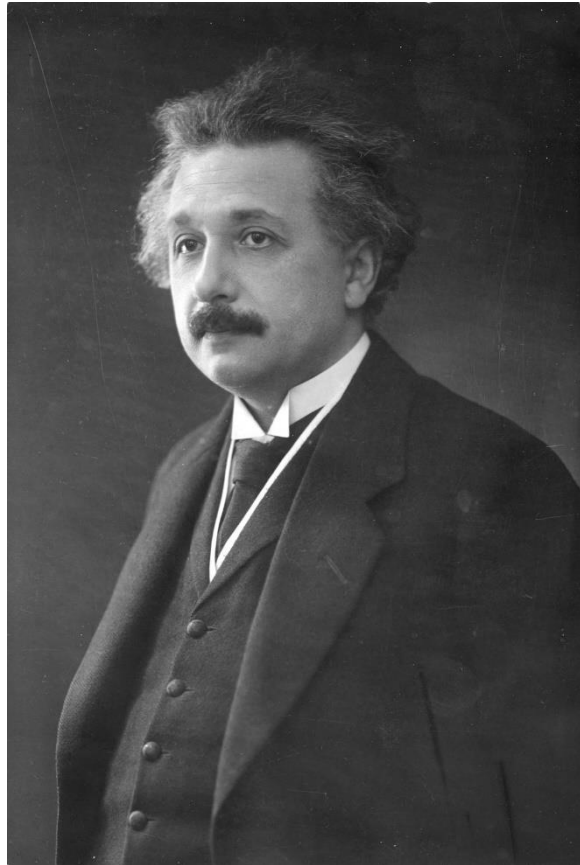

Albert Einstein, 1879 – 1955

# Questions for 2019

---

- **Q1: What was Einstein's explanation of how radio works?**
- **A: "You see, wire telegraph is a kind of a very, very long cat. You pull his tail in New York and his head is meowing in Los Angeles. Do you understand this? And radio operates exactly the same way: you send signals here, they receive them there. The only difference is that there is no cat." – Albert Einstein**

# Questions for 2019

---

- **Q1: What was Einstein's explanation of how radio works?**
- **A: "You see, wire telegraph is a kind of a very, very long cat. You pull his tail in New York and his head is meowing in Los Angeles. Do you understand this? And radio operates exactly the same way: you send signals here, they receive them there. The only difference is that there is no cat." – Albert Einstein**
- **Q2: Was Einstein correct?**



# Answer: Hmm

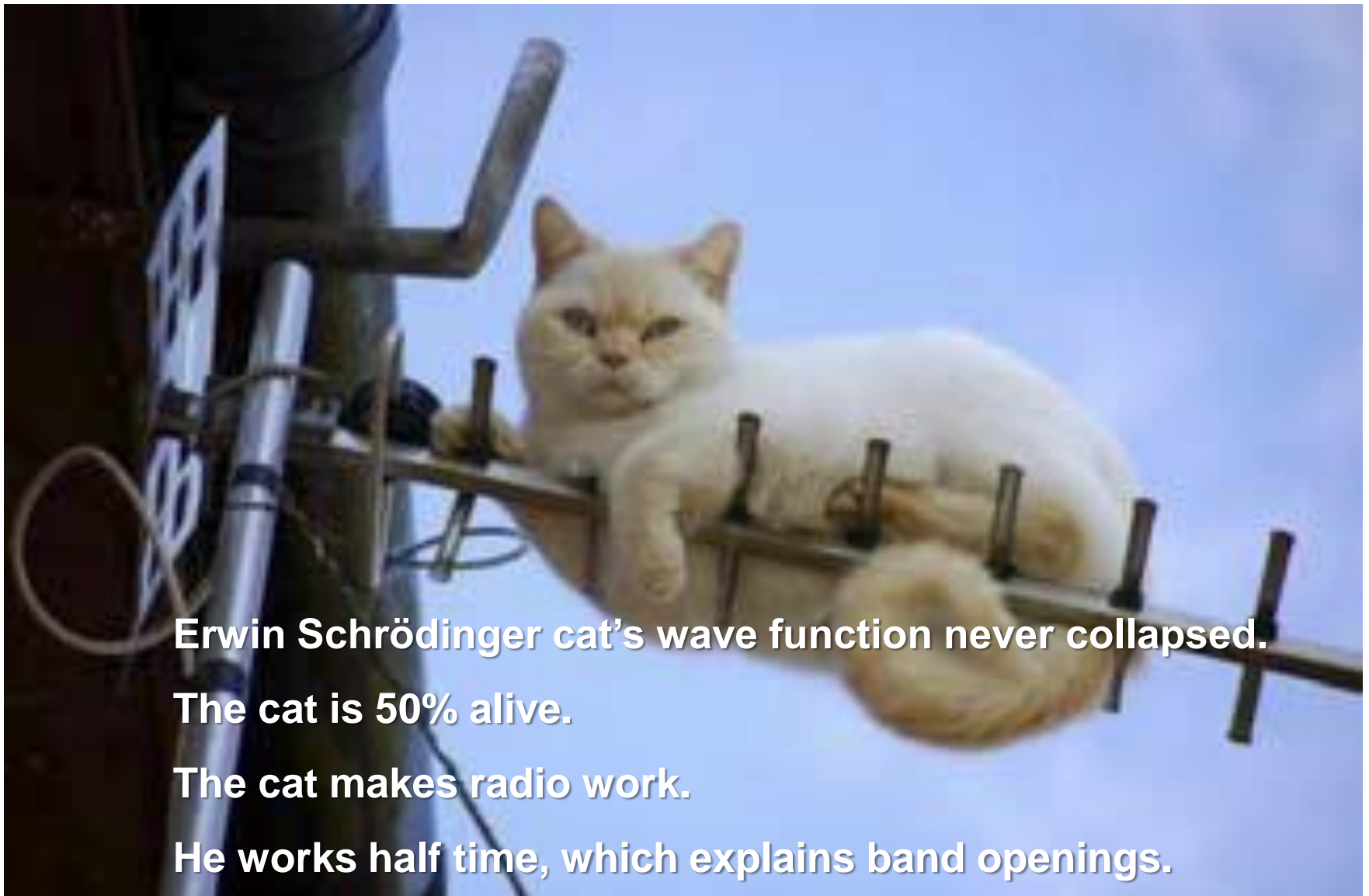

Erwin Schrödinger cat's wave function never collapsed.

The cat is 50% alive.

The cat makes radio work.

He works half time, which explains band openings.

# How HF Radio Works

Cats handle radio communications in the ionosphere

Old Deuteronomy sends Jellicle cats “up, up, up, past the Russell Hotel to the Heaviside Layer”



# CATS

Music by  
**Andrew Lloyd Webber**  
based on 'Old Possum's Book  
Of Practical Cats' by T.S. Eliot

# Basic Questions About Transducers

---

- **Q3: In acoustics, can a loudspeaker have an isotropic pattern?**
  - A. Yes
  - B. No
- **Q4: Can an antenna have an isotropic pattern?**
  - A. Yes
  - B. No

# Answers

- **Q3: In acoustics, can a loudspeaker have an isotropic pattern?**
  - A. Yes. Sound waves are longitudinal. Isotropic patterns are possible.
  - B. No
- **Q4: Can an antenna have an isotropic pattern?**
  - A. Yes
  - B. No. Electromagnetic waves are transverse or TEM. Isotropic patterns are impossible – a consequence of the **Hairy Ball Theorem** proved in 1912 by Dutch mathematician L.E.J. Brouwer

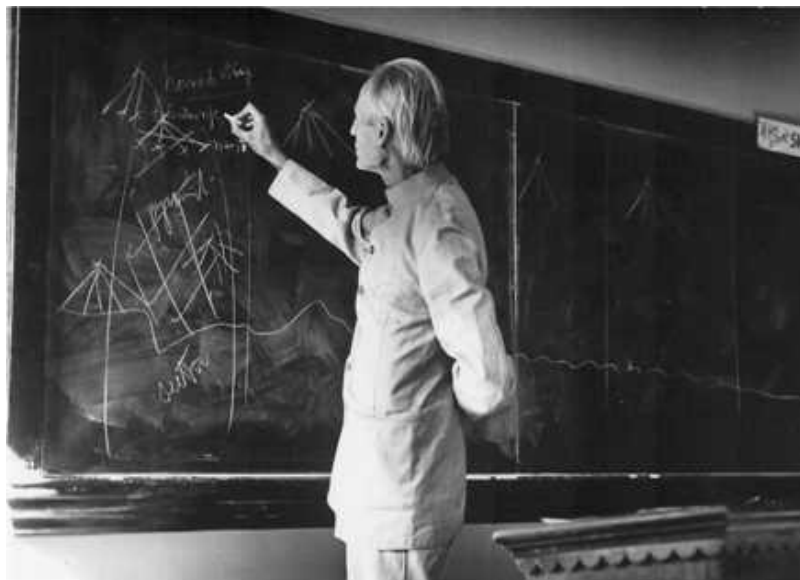

# Now for Some Questions About Dipoles

---

- Assume a lossless dipole shrinks in size compared to a wavelength such that its length and diameter approach zero
- **Q5: Does its maximum gain in dBi units go to**
  - A. 0 dBi (zero dBi)
  - B.  $-\infty$  dBi (minus infinity dBi)
  - C. Some other number
- **Q6: Does its capture area (effective area) go to**
  - A. 0 (zero)
  - B. Some other number

# Answers

---

- **Assume a lossless dipole shrinks in size compared to a wavelength such that its length and diameter approach zero**
- **Q5: Does its maximum gain in dBi units go to**
  - A. 0 dBi (zero dBi)
  - B.  $-\infty$  dBi (minus infinity dBi)
  - C. Some other number: 1.76 dBi
- **Q6: Does its capture area (effective area) go to**
  - A. 0 (zero)
  - B. Some other number:  $\infty$  infinity

This is good news for hams who operate in the 1750 and 2200 meter bands

The issues of electrically small antennas are not about directivity or effective area

The issues are antenna bandwidth and losses

# Outline

---

- **Linear cylindrical antennas**
  - Dipoles
- **Transmit properties**
  - Current distribution
  - Near fields
  - Far field
  - Pattern, directivity, and gain
- **Receive properties**
  - Scattering and receive near field
  - Poynting vector field deflection
  - Effective length and capture area
- **Dipole impedance**
  - Frequency dependence
  - Resonant lengths
  - The multiplying factor  $K$  for first resonance
- **Antenna modeling using Method of Moments programs**
  - Capabilities and limitations
- **Resources**
  - Antenna books

---

# Linear Cylindrical Antennas



# Definitions

- **A linear cylindrical antenna is a wire, rod, or tube driven at an arbitrary point (a gap) along its length**
  - Length is arbitrary
  - Feedpoint location is arbitrary
  - Arms are colinear
  - Cross-section need not be circular or convex or topologically connected
- **A simple dipole is a linear cylindrical antenna that is symmetric about its feedpoint**
  - Arm lengths  $L_1$  and  $L_2$  are equal
  - Current distribution is symmetric
  - Feedpoint is balanced
  - The half-wave dipole is called a “Hertz” dipole or “doublet”
- **Examples**
  - A cage dipole is a dipole
  - An off-center fed (OCF) dipole is misnamed; it is a linear cylindrical antenna but not a dipole
  - A fan dipole is not a dipole nor a linear cylindrical antenna but is made of several dipoles

# Truths

- A simple dipole is symmetric and center fed



A.C. = a cat

- For lossless antennas, directivity and gain are the same
- An antenna's radiation resistance is not unique. It depends on a reference current or location
- The resonant length of a dipole depends on its diameter
- Dipoles are resonant at lengths slightly shorter than an odd number of half-wavelengths
  - The resonant length of a Hertz dipole or doublet is  $L = \frac{K\lambda}{2}$
  - $K$  depends on resonance number and dipole fatness
- Dipoles are anti-resonant at lengths slightly shorter than an even number of half-wavelengths
- If linear antenna is resonant, then its feedpoint impedance is real everywhere along its length
- If a dipole is a half-wavelength, then its current phase is  $\sim 30^\circ$  everywhere along its length (taking feed voltage as reference phase)

# Fictions

---

- **A dipole should be one-half wavelength long**
- **Half-wavelength dipoles are resonant**
- **Dipoles are 75 ohms**
- **In free space, a half-wavelength dipole has a real (resistive) feedpoint impedance**
- **A half-wavelength dipole is 50 ohms**
- **The feedpoint resistance of a half-wavelength dipole depends on its diameter**
- **The feedpoint reactance of a half-wavelength dipole depends on its diameter**
- **Dipoles are anti-resonant at lengths slightly longer than an even number of half-wavelengths**

---

# Dipole Current, Impedance, and Resonant Length

# The Dipole's Origin – Heinrich Hertz, 1887



Heinrich Rudolph Hertz, 1857-1894

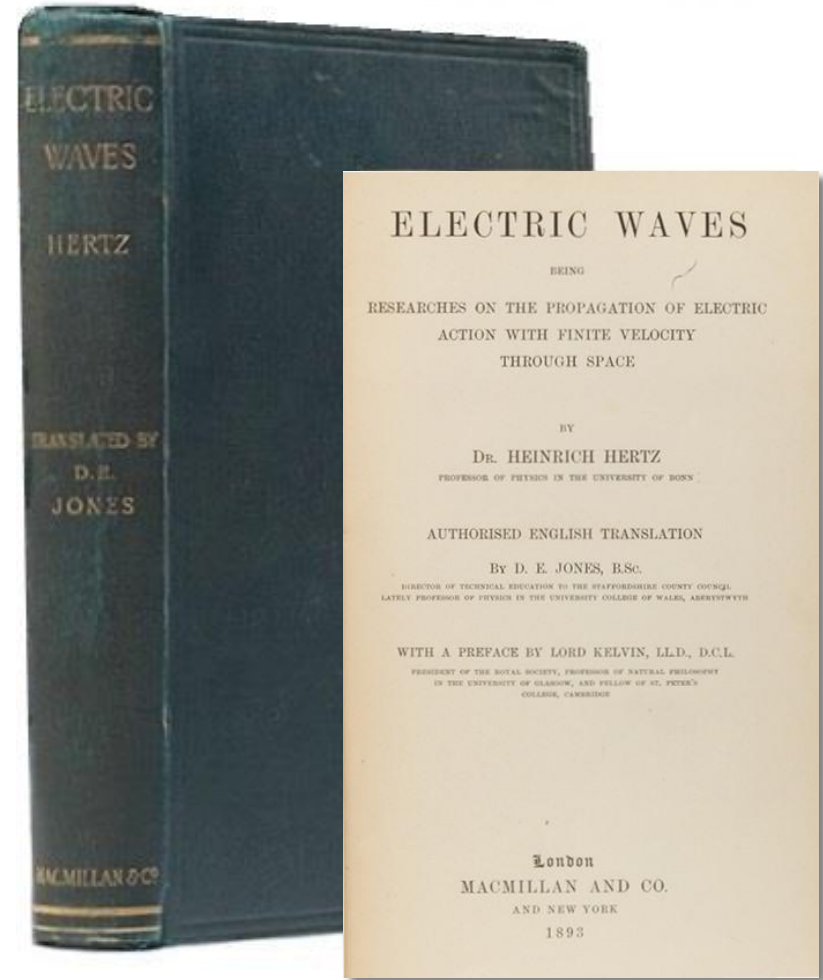
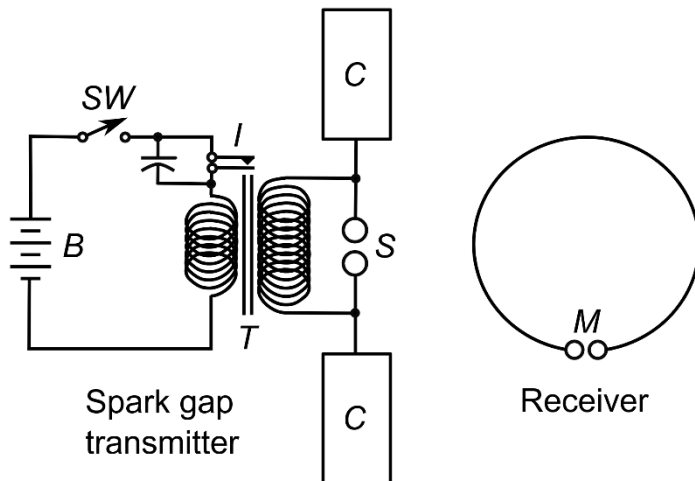

The first antenna book, 1893

# Milestones in Cylindrical Antennas

- **Heinrich Hertz's experiments (1887)**
- **Pocklington's integro-differential equation (1897)**
  - Solved numerically in NEC
- **Induced EMF (IEMF) method (1922)**
  - L. Brillouin, *Radioélectricité*, April 1922
  - A.A. Pistolkors, *Proc. IRE*, March 1929
  - P.S. Carter, *Proc. IRE*, June 1932
  - S.A. Schelkunoff, papers and books 1941-1954
  - C-T. Tai, *J. Applied Physics*, July 1949
- **Hallén's integral equation (1938)**
  - E. Hallén at Uppsala University, Sweden
  - C.J. Bouwkamp at Philips Labs, Holland
  - R.W.P. King and students at Harvard University
    - F.G. Blake
    - C.W. Harrison
    - D. Middleton
  - S.A. Schelkunoff and M.C. Gray at Bell Labs

# Integral Equations for Dipole Current

- Pocklington's equation (1897)

$$\int_{-l}^l I_z(z') \left[ \left( \frac{\partial^2}{\partial z'^2} + k^2 \right) G(z, z') \right] dz' = -j\omega\epsilon E_z^i(\rho = a)$$

- Hallen's equation (1938)

$$\int_{-l}^l I_z(z') \frac{e^{-jkR}}{4\pi R} dz' = -j\sqrt{\frac{\epsilon}{\mu}} [B_1 \cos(kz) + C_1 \sin(k|z|)]$$

- General form

$$\text{Linear operator} \rightarrow L(f) = g \leftarrow \text{Driving function}$$

Unknown function

# Linear Cylindrical Antennas



**Ronald Wyeth Percival King, 1905-2006**

- **Speaking at his 100<sup>th</sup> birthday party, Oct. 2005**
- **Cruft Laboratories, Harvard University**
- **Authority on linear cylindrical antennas**
- **Spent his career on solving Hallén's equation, starting in 1938**
- **Had many famous students who worked on ever better solutions to Hallén's equation**



# Current Distribution of an Almost Resonant Dipole

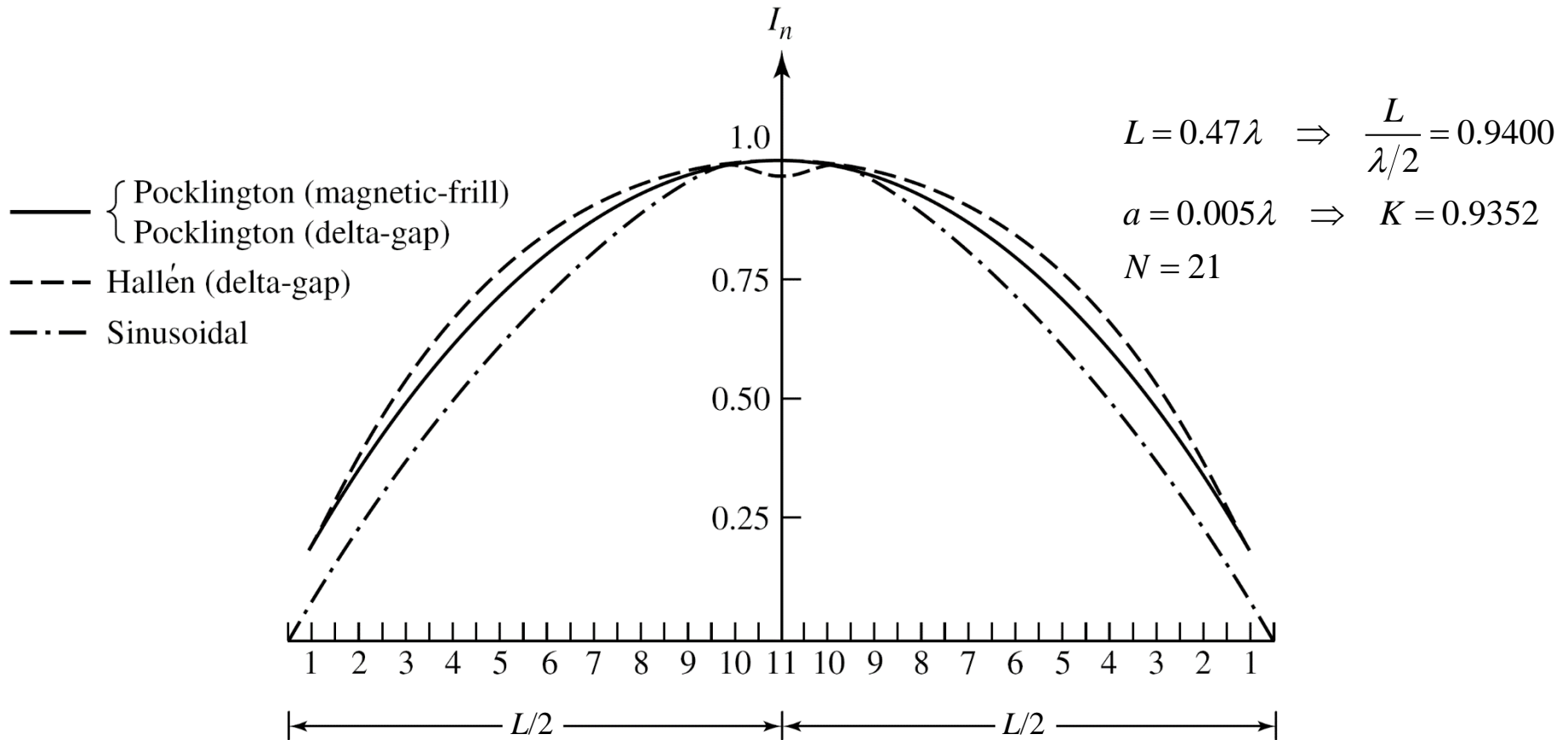

C.A. Balanis, *Antenna Theory: Analysis and Design*, 4<sup>th</sup> ed., p. 457, Wiley, 2016

# Current Distribution on Two Halfwave Dipoles

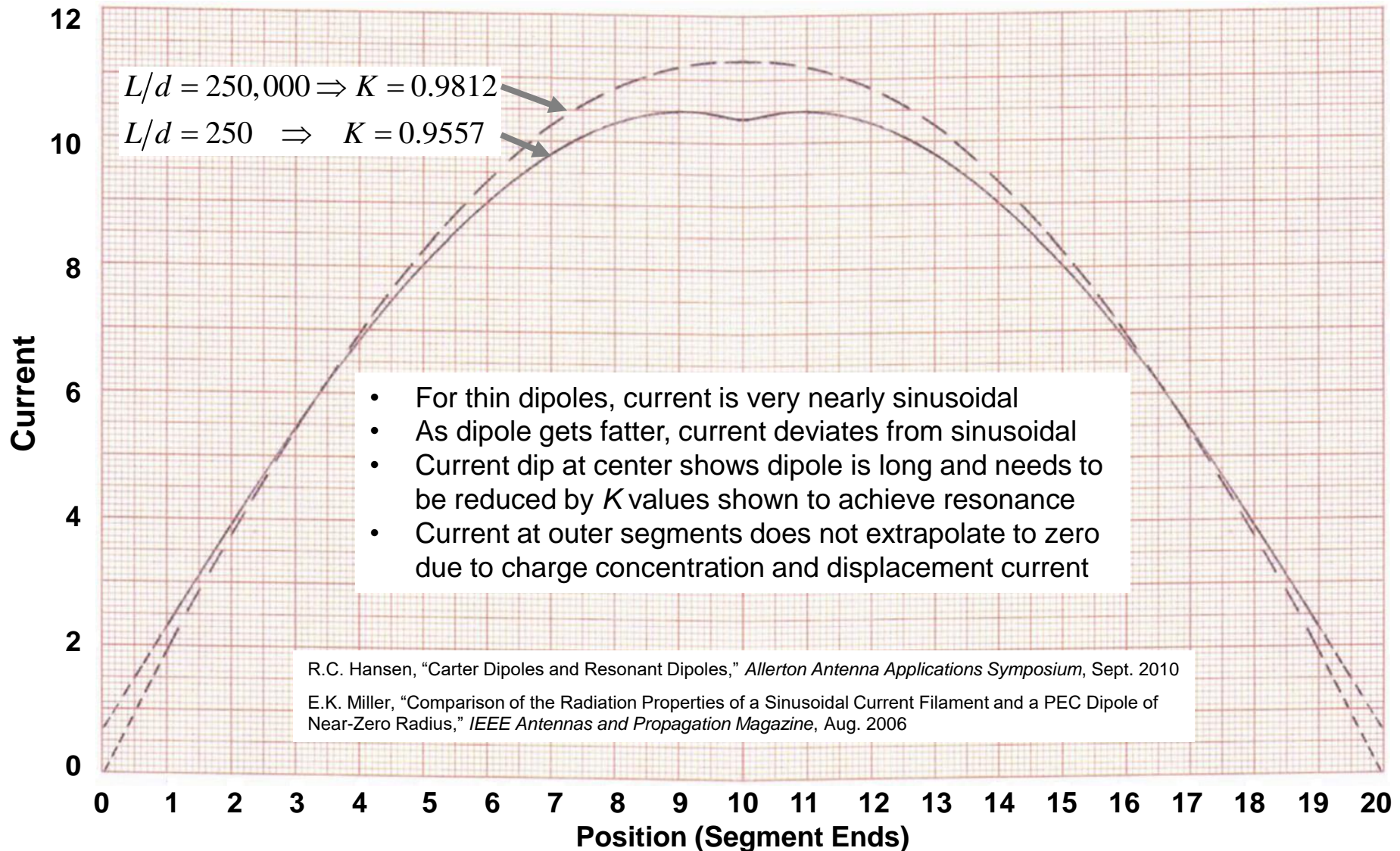

# Induced EMF Method

- L. Brillouin, *Radioélectricité*, April 1922
- A.A. Pistolkors, *Proc. IRE*, March 1929
- P.S. Carter, *Proc. IRE*, June 1932
- C-T. Tai, *J. Applied Physics*, July 1949
- Assume sinusoidal current distribution
- Obtain pattern, radiation resistance and reactance
- Accurate for pattern and impedance of dipoles up to half-wavelength and verticals up to quarter-wavelength
- Inaccurate for impedance of dipoles longer than half-wavelength and verticals longer than quarter-wavelength
- Widely used for the design of AM broadcast towers
- Obsoleted by numerical methods

*Proceedings of the Institute of Radio Engineers*  
Volume 20, Number 6 June, 1932

## CIRCUIT RELATIONS IN RADIATING SYSTEMS AND APPLICATIONS TO ANTENNA PROBLEMS\*

BY

P. S. CARTER

(R.C.A. Communications, Inc., Rocky Point, L. I., N.Y.)

*Summary*—Expressions for the self and mutual impedances within a radiating system are developed by the use of the generalized reciprocity theorem. These expressions are given in terms of the distributions of the electric field intensities along the radiators.

A method for the determination of the field intensities is outlined. Formulas for the self and mutual impedances in several types of directional antennas are given.

Questions of practical interest in connection with arrays of half-wave dipoles, long parallel wires, and "V" type radiators are discussed. Different types of reflector systems are considered. Curves of the more important relations are shown.

The mathematical development is shown in an appendix.

IN THE design and the adjustment of antenna systems a knowledge of certain characteristics and relations is of great assistance.

We should know the theoretical directivity, that is, the ratio of the intensity of radiation in a desired direction to the mean intensity in all directions. The contribution of each radiating element to the total radiated power and the interactions between elements are important. In a good system the ratio of heat losses to radiated power must be low.

The intensity of radiation in the desired direction is relatively easy to obtain. To determine the total power we may, for mathematical purposes, imagine the system placed at the center of a very large sphere and compute the power flow through each element of area on the sphere. A summation gives the total. The average intensity is then this total divided by the number of units of solid angle contained in the sphere. The application of this method to long linear radiators and several types of directional antenna systems has been shown by the writer in detail.<sup>1</sup> Upon completion of this process we have a complete knowledge of the power flow in every direction in space but are left in entire ignorance as to the portions of this power contributed by the various antenna elements and as to the interactions between these elements.

To the communications engineer, who is quite familiar with the use of impedance operators in connection with ordinary circuit calcula-

\* Decimal classification: R116. Original manuscript received by the Institute, March 1, 1932. Presented before Twentieth Anniversary Convention of the Institute, Pittsburgh, Pa., April 9, 1932.

<sup>1</sup> Carter, Hansell, Lindenblad, "Development of directive transmitting antennas by R.C.A. Communications, Inc.," *Proc. I.R.E.*, vol. 19, pp. 1773-1842; October, (1931).

1004

# Dipole Impedance via the Induced EMF Method

## ■ Resistance

$$R_{in} = \frac{\eta}{4\pi \sin^2(kl)} \left\{ 2\gamma + 2\ln(2kl) - 2\text{Ci}(2kl) + \sin(2kl) [\text{Si}(4kl) - 2\text{Si}(2kl)] + \cos(2kl) [\text{Ci}(4kl) - 2\text{Ci}(2kl) + \gamma + \ln(kl)] \right\}$$

Terms vanish when  $l / \lambda$  is a half integer; impedance is independent of wire diameter for such lengths

## ■ Reactance

$$X_{in} = \frac{\eta}{4\pi \sin^2(kl)} \left\{ 2\text{Si}(2kl) - \cos(2kl) [\text{Si}(4kl) - 2\text{Si}(2kl)] + \sin(2kl) [\text{Ci}(4kl) - 2\text{Ci}(2kl) + \gamma + 2\ln(ka) - \ln(kl)] \right\}$$

## ■ Assumptions

- Circular cylindrical dipole
- In free space
- Made of PEC → no losses
- Length  $L = 2l \leq \lambda/2$
- Radius  $a$

Wire radius affects only reactance

# Halfwave Dipole – Impedance to 10 Digits

- Resistance

$$R_{in}\left(\frac{\pi}{2}, ka\right) = \frac{\eta}{4\pi} \left[ \gamma + \ln(2\pi) - \text{Ci}(2\pi) \right] = \frac{\eta}{4\pi} \sum_{n=1}^{\infty} \frac{(-1)^{n+1} (2\pi)^{2n}}{2n (2n)!} = 29.9792458 \times 2.437653393$$

$$R_{in} = 73.07901025 \text{ ohms}$$

- Reactance

$$X_{in}\left(\frac{\pi}{2}, ka\right) = \frac{\eta \text{Si}(2\pi)}{4\pi} = \frac{\eta}{4\pi} \sum_{n=1}^{\infty} \frac{(-1)^n (2\pi)^{2n+1}}{(2n+1)(2n+1)!} = 29.9792458 \times 1.418151576$$

$$X_{in} = 42.51511468 \text{ ohms}$$

- Is there practical value to such precise numbers?
- Yes, exact theoretical values are needed to validate the accuracy of numerical codes like NEC, FEKO, WIPL-D, and HOBBIES



# Complex Impedance as Frequency is Swept

## ARRL Semilog Impedance Plane

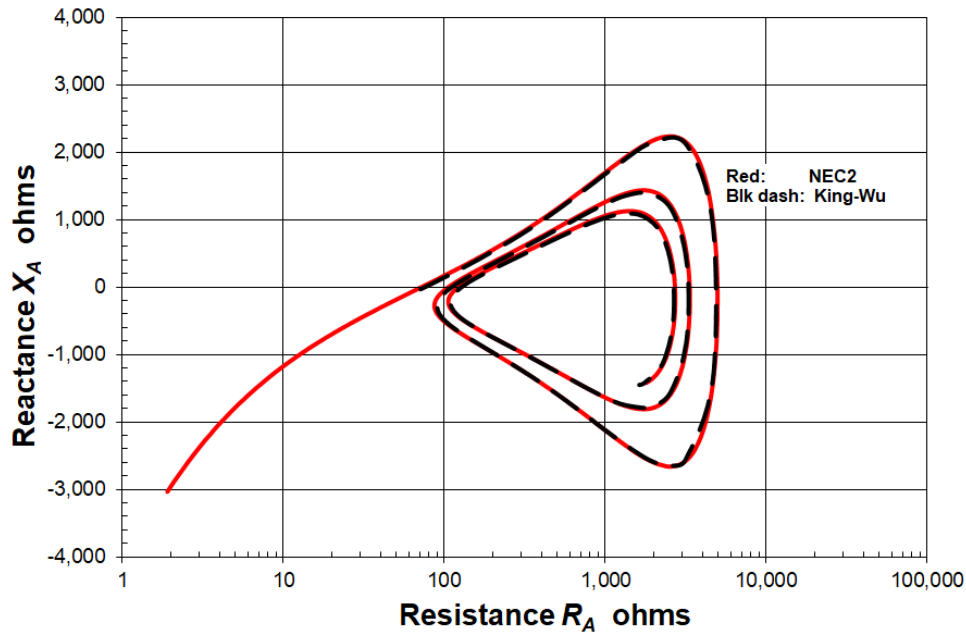

## Smith Chart

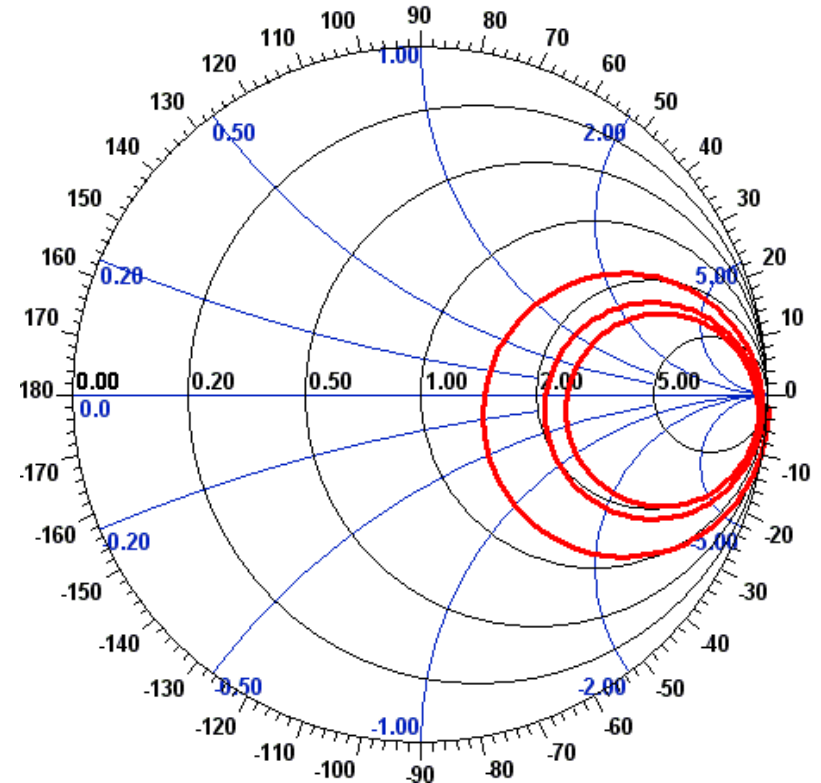

- Antenna: 98.4-foot dipole in free space
- Wire: #10 AWG
- $L/d = 11,000$
- Frequency: 1 MHz to 30 MHz

# Q of Small Dipole from Electromagnetic Field Analysis

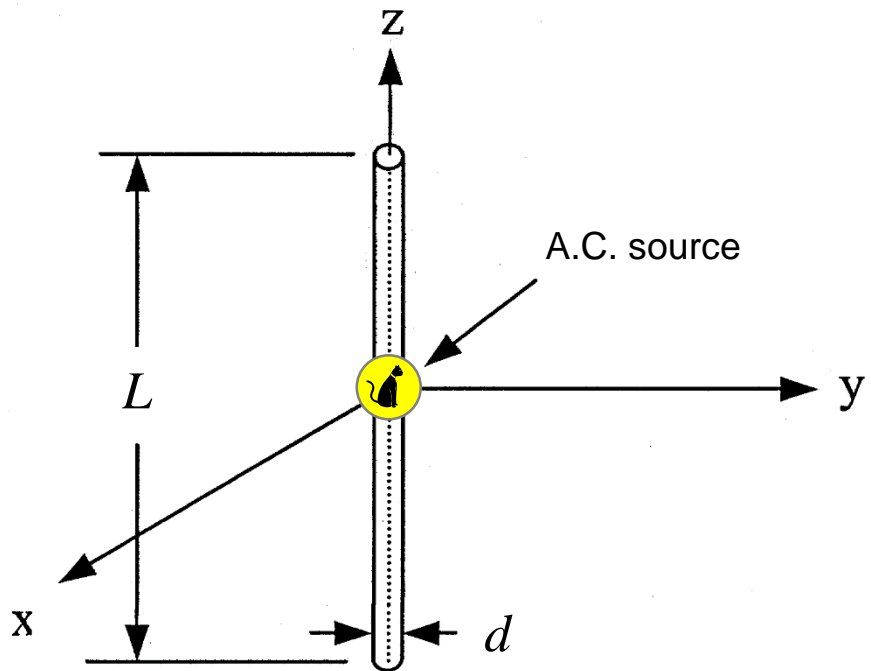

$$Q_{dipole} \approx \frac{6 \left[ \ln\left(\frac{L}{d}\right) - 1 \right]}{\pi^3 \left( \frac{fL}{c} \right)^3}$$

---

# **Equivalent Circuits for Dipole Impedance**

## **Narrowband and Very Broadband**



# Narrowband Equivalent Circuits Near 1<sup>st</sup> Resonance

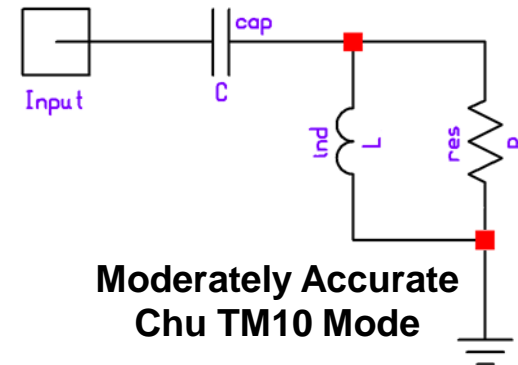
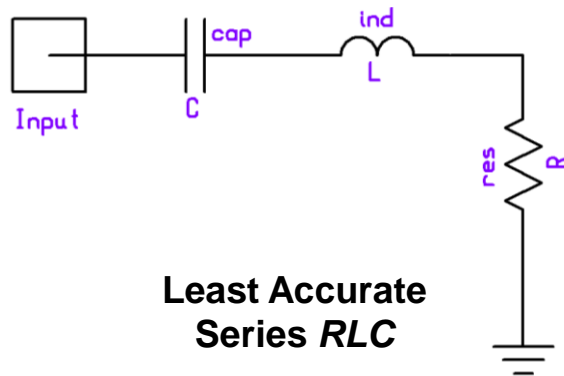
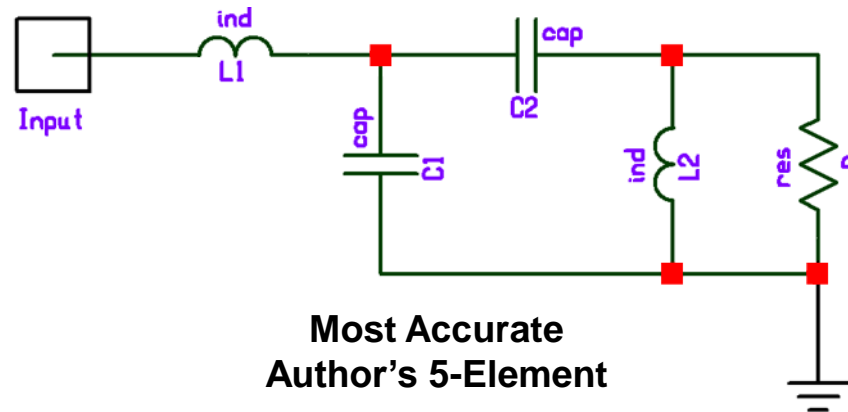

- All are lumped element circuits in Darlington form
  - Cauer reactance 2-port with resistor termination)
- Resistor represents radiation plus loss resistances
- All are determined by fitting to dipole impedance data, computed or measured, or by continued fraction synthesis

# Two-Port Equivalent Circuit

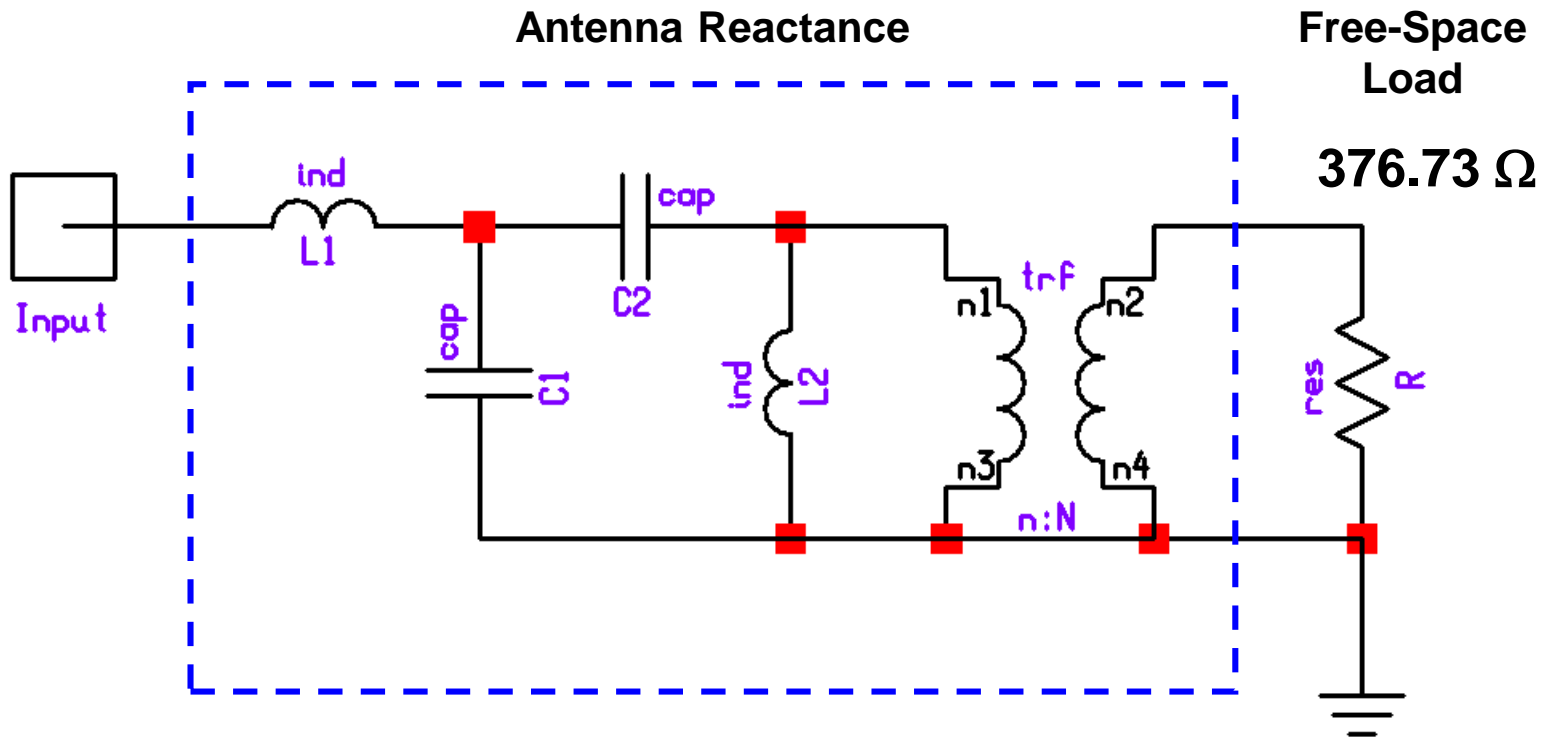

# Broadband Equivalent Circuit for 98.4-foot Dipole ( $L/d = 11,000$ ) from Zero to 30 MHz

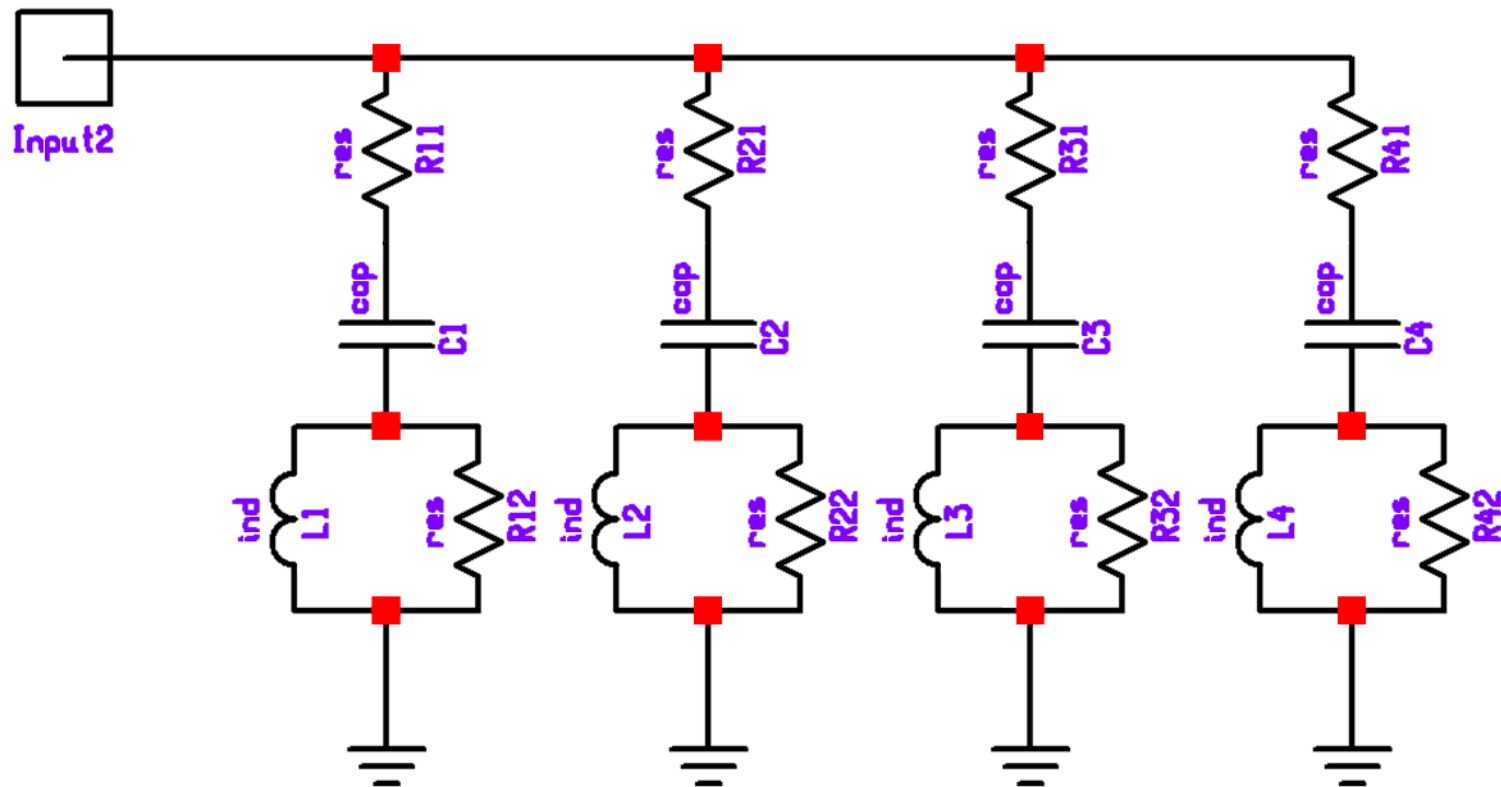

$$R11 = 5.06 \Omega$$

$$C1 = 39.9 \text{ pF}$$

$$L1 = 27.1 \mu\text{H}$$

$$R12 = 10.1 \text{ k}\Omega$$

$$R21 = 0 \Omega$$

$$C2 = 4.64 \text{ pF}$$

$$L2 = 24.9 \mu\text{H}$$

$$R22 = 50.1 \text{ k}\Omega$$

$$R31 = 25.5 \Omega$$

$$C3 = 4.69 \text{ pF}$$

$$L3 = 2.26 \mu\text{H}$$

$$R32 = 2.68 \text{ k}\Omega$$

$$R41 = 0 \Omega$$

$$C4 = 1.68 \text{ pF}$$

$$L4 = 24.5 \mu\text{H}$$

$$R42 = 116 \text{ k}\Omega$$

# Accuracy of Broadband Equivalent Circuit

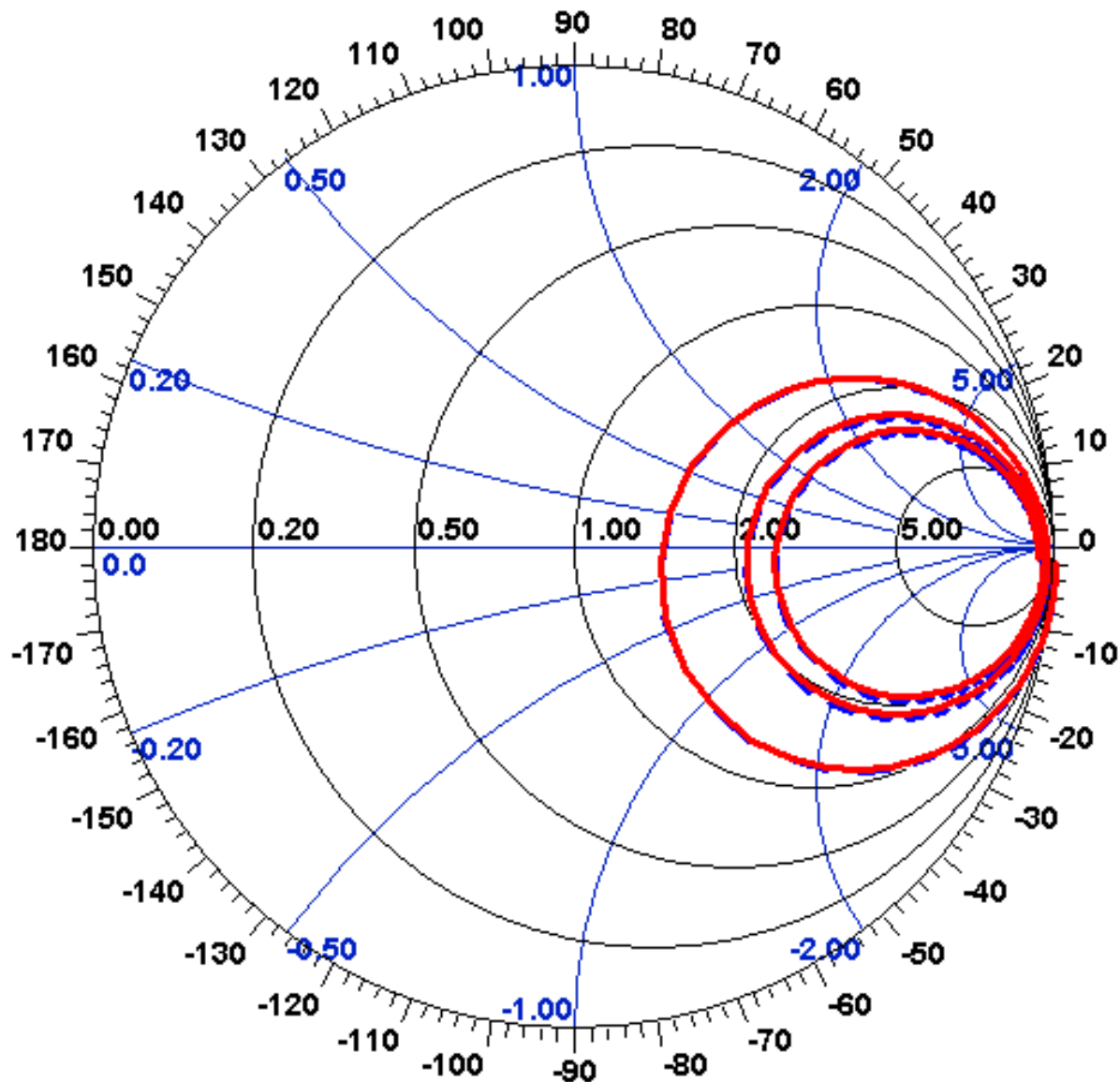

# Broadband Equivalent Circuit for 2-meter Dipole ( $L/d = 50$ ) from Zero to 1.5 GHz

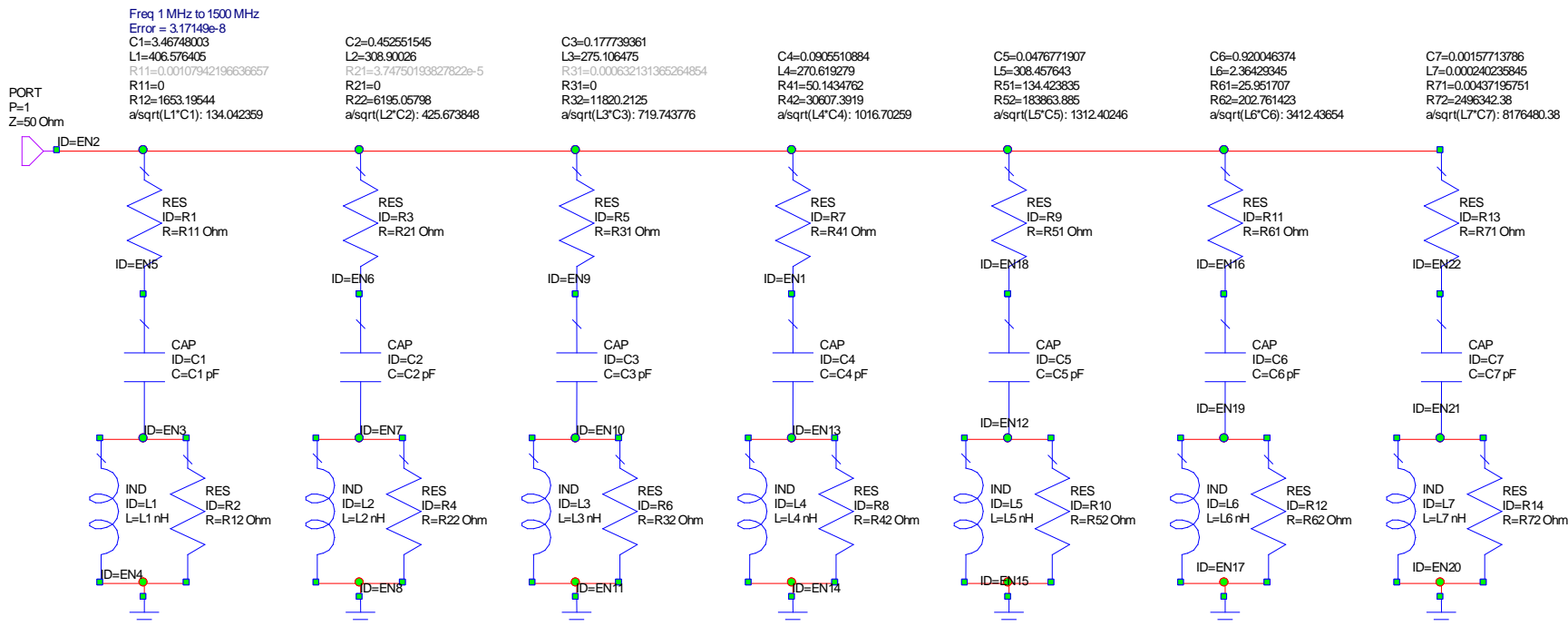

- Introduced by the author (2007)
- Partial fraction expansion of dipole admittance
- A modification of Foster's 2<sup>nd</sup> canonical form
- More accurate than other broadband equivalent circuits for dipoles, viz. Hamid-Hamid (1997), Rambabu-Ramesh-Kalghatgi (1999), and Streable-Pearson (1981)
- Six stages sufficient to cover  $d$ -c to 1.5 GHz

# Accuracy of Broadband Equivalent Circuit

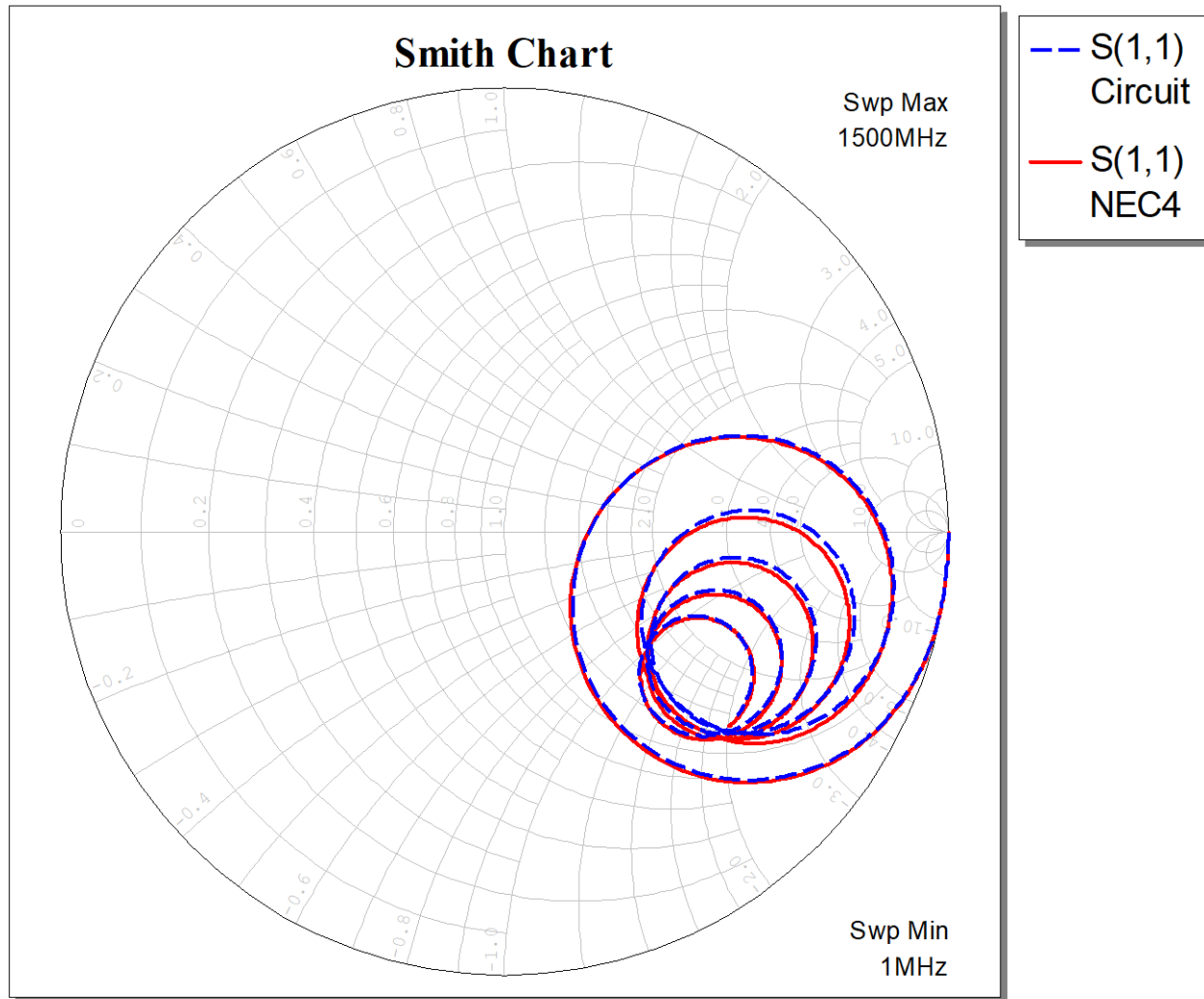

# Impedance Accuracy of Broadband Equivalent Circuit

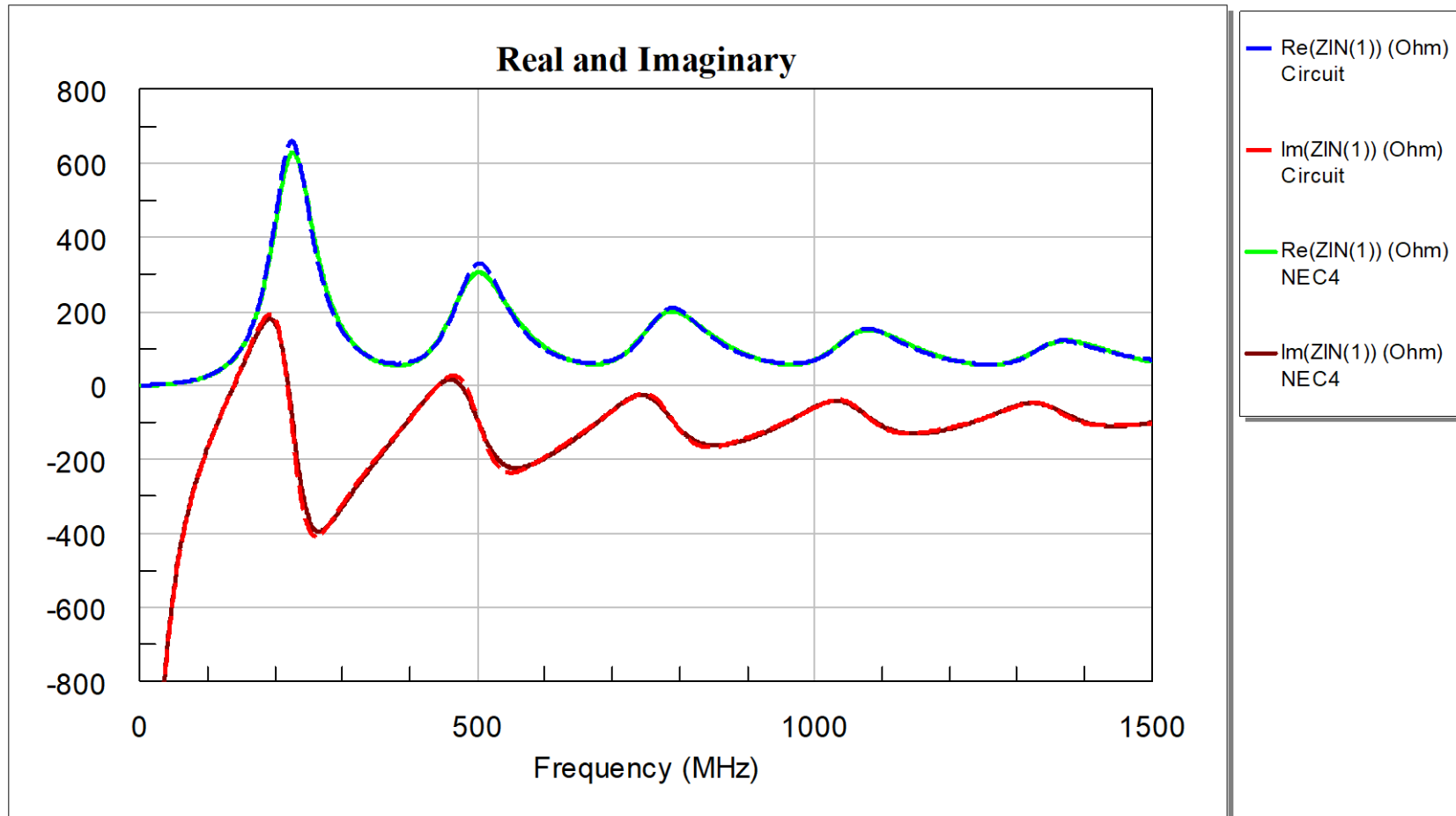

---

# Dipole Resonance and Resonant Length

## The Mysterious Factor $K$



# Two Definitions of Resonance

- **Electric field energy equals magnetic field energy**

$$\iiint \left( \epsilon_0 |E|^2 - \mu_0 |H|^2 \right) dV = 0$$

- Some authors exclude radiation energy and consider only stored energy that is not associated with radiation, i.e. real power delivery to infinity

- **Feedpoint reactance is zero**

$$X(f) = 0$$

- This definition is standard but less fundamental
- A nonresonant antenna can be made resonant, and vice versa, by incorporating transmission line
- If an antenna's impedance curve lies entirely in the upper or lower half of the Smith chart and does not cross the horizontal  $X = 0$  midline, then it has no resonances

# Dipole Resonant Length

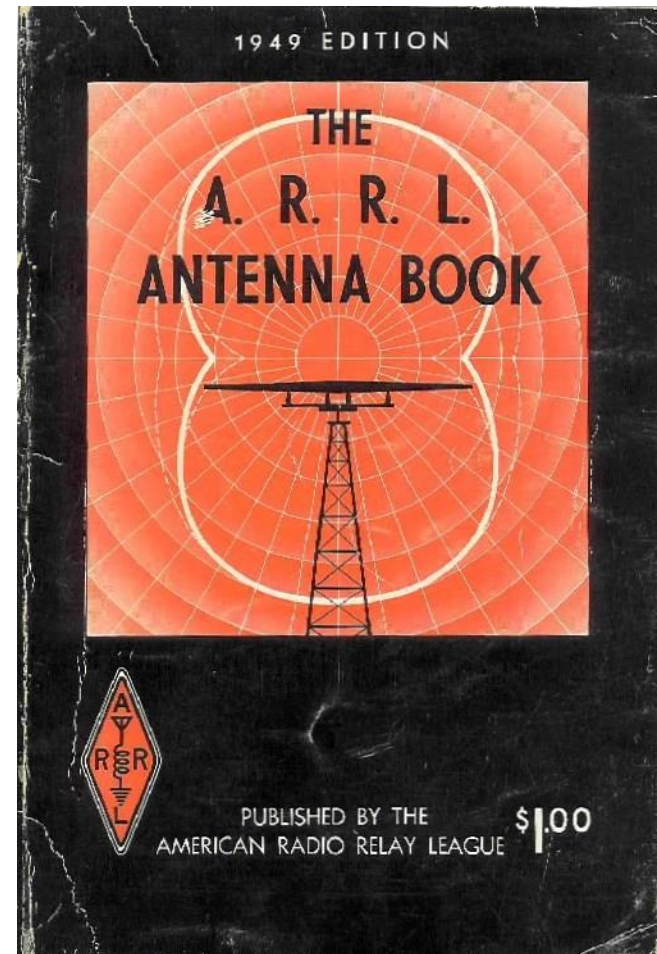
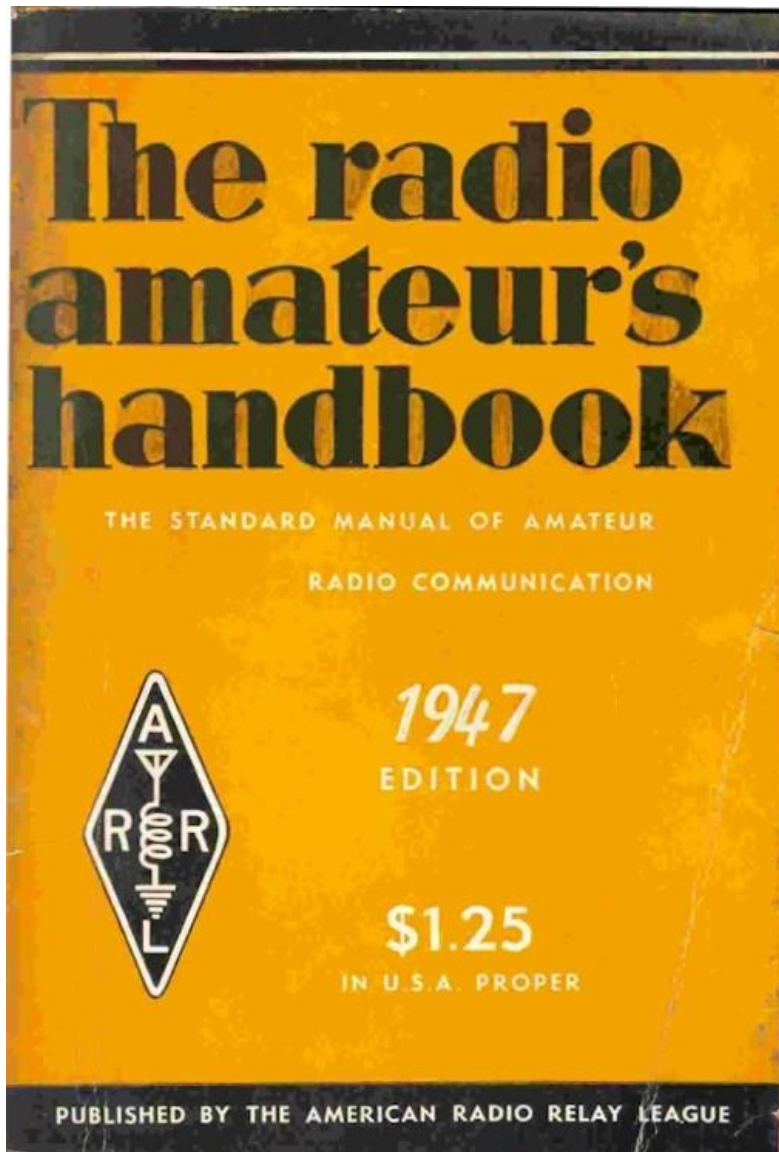

# The Multiplying Factor $K$

ARRL 1947-1997

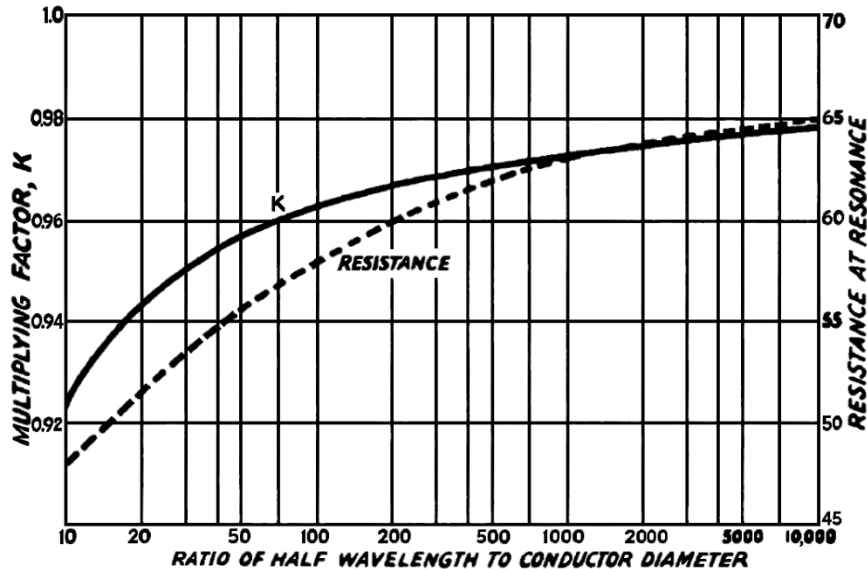

ARRL 1998-2018

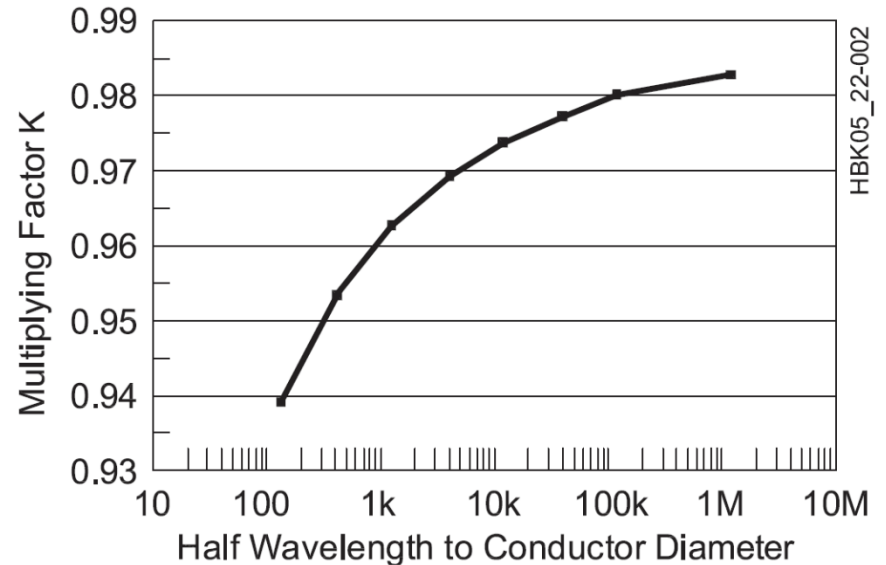

$$L_{res} = K \times \frac{\lambda}{2} = K \times \frac{491.786}{f_{MHz}} \text{ feet}$$

$K$  is not a velocity factor !

# The "K" Universe – Who is Right?

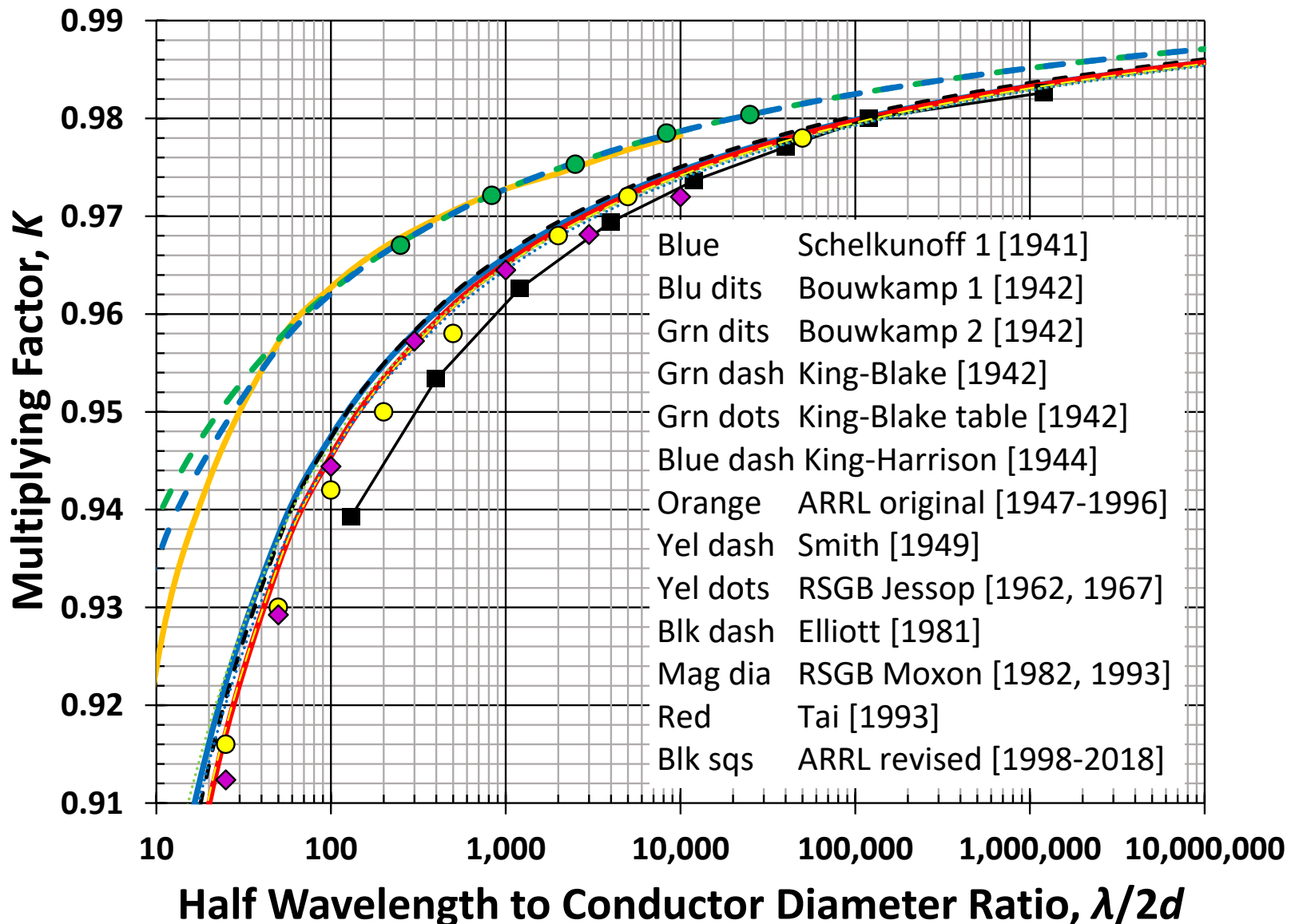

# Three Half-Baked Theories of the Multiplying Factor $K$

## Theory 1: $K$ is a velocity factor

- Claim: Dipole is a transmission line and  $K$  is a velocity factor
- No physical basis exists for non-unity velocity factor
  - Only materials are PEC metal and vacuum, no dielectric or losses
- Schelkunoff's wave theory of antennas has velocity factor = unity

## Theory 2: $K$ is an “end” effect

- Claim: Dipole is a quarter-wave transmission line, velocity factor = 1, but fringing capacitance at ends transforms to inductance at feedpoint
- Forward and reverse traveling waves would give a sinusoidal current standing wave, but this is not the case

## Theory 3: $K$ is due to current distribution not being sinusoidal

- True, the magnitude of the current distribution deviates from sinusoidal as a dipole gets fatter, but this does not explain  $K$
- $K$  is predicted accurately by the induced e.m.f. method which assumes sinusoidal current distribution; so non-sinusoidal current is not the explanation

# The Real $K$

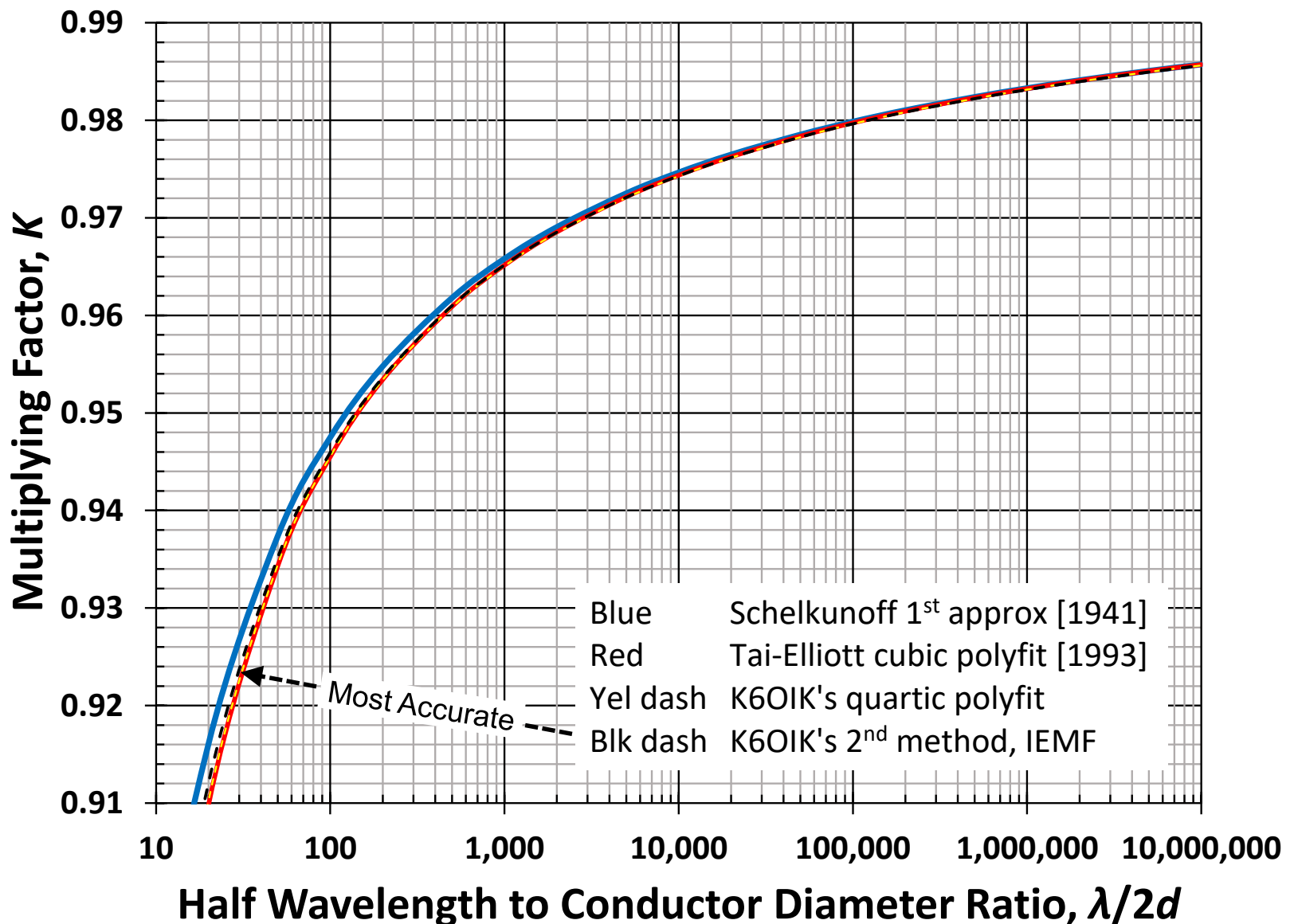

# Comments on the Multiplying Factor $K$

- **Most popular expositions on  $K$  are partly correct at best**
  - $K$  is not a velocity factor
  - $K$  is not an “end” effect
  - $K$  is not due to departure from sinusoidal current distribution
- **$K$  can be determined by rigorous methods**
  - Induced e.m.f. method gives  $K$  accurately for the 1<sup>st</sup> resonance
  - Best method: Analyze a dipole as a boundary value problem
  - Solve Pocklington’s or Hallén’s equations for the current on the antenna
  - $K$  is found from the dipole length for which the feedpoint reactance is zero
- **Numerical methods are fine, but MoM has a caveat**
  - Antenna models that use delta-gap sources and MoM do not predict resonance or  $K$  very accurately

Antenna models that use delta-gap sources and MoM do not predict resonance or  $K$  very accurately.

---

# **Radiation Behavior**

**Near field**

**Far field**

**Pattern**

**Directivity and gain**

**Effective Rx capture area**



# Radiation

- DC and AC steady-state currents produce magnetic fields
- However only AC currents produce fields (electromagnetic) that radiate, i.e. propagate or travel away from the source with little attenuation
- In EE terms, time-varying current produces radiation
- In classical physics, the acceleration of charge creates radiation
  - Larmor's equation: A charged particle radiates when accelerated, and the radiated power is proportional to the square of the acceleration
- In modern physics, photon energy is  $E = hf$ , where  $h$  is Planck's constant and  $f$  is frequency
  - If an antenna radiates 100 W at 146 MHz,  
 $E = 6.62 \times 10^{-34}$  Joule-sec  $\times 146 \times 10^6 = 9.67 \times 10^{-26}$  J/photon  
Photon rate =  $100 / 9.67 \times 10^{-26} = 1 \times 10^{27}$  photons/sec  
= 1 billion billion billion photons per second

# Coordinate Systems

- Antenna radiation properties fields and pattern are defined in the antenna's local coordinate system
  - Cartesian:  $x, y, z$
  - Spherical:  $r, \theta, \phi$
- Z is “zenith”
- $\theta$  (theta) is polar angle measured from North pole
- $\phi$  (phi) is “azimuth” angle measured counter-clockwise from the X axis
- If ground is present, the X-Y plane is the interface and the antenna is in the upper half space  $z > 0$
- A direction is specified by two angles
  - Spherical:  $\theta, \phi$
  - Alternate:  $\alpha = \pi/2 - \theta$  (elevation angle),  $\beta = \pi/2 - \phi$  (clockwise az)

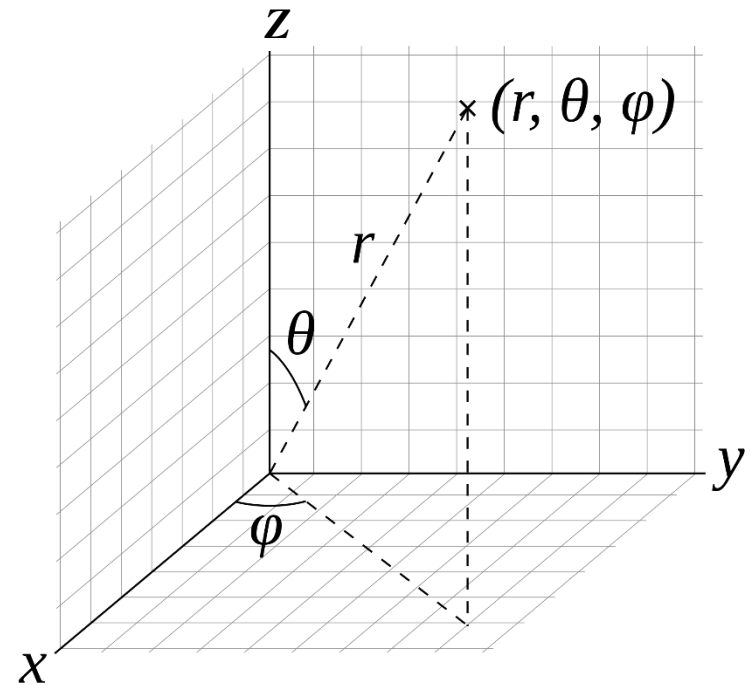

# Electric and Magnetic Fields of an Infinitesimal Dipole

- Fields of an infinitesimal dipole on Z axis in free space (or an infinitesimal monopole over an infinite PEC ground plane)

$$H_r = H_\theta = 0$$

$$H_\phi = j \frac{k I_0 l \sin \theta}{4\pi r} \left[ 1 + \frac{1}{jkr} \right] e^{-jkr}$$

$$E_r = \eta \frac{k I_0 l \cos \theta}{4\pi r} \left( \frac{2}{kr} \right) \left[ 1 + \frac{1}{jkr} \right] e^{-jkr}$$

$$E_\theta = j\eta \frac{k I_0 l \sin \theta}{4\pi r} \left[ 1 + \frac{1}{jkr} - \frac{1}{(kr)^2} \right] e^{-jkr}$$

$$E_\phi = 0$$

Near field terms assuming

- Uniform current distribution with
  - Current  $I_0$
  - Dipole length  $l$
- Triangular current distribution with
  - Peak current  $I_0$
  - Dipole length  $2l$

One radianlength defined as  $r = 1/k = \lambda/2\pi$  is the distance at which far field and near field terms are equal.

# Heinrich Hertz's Drawings of Electric Fields of a Dipole circa 1888

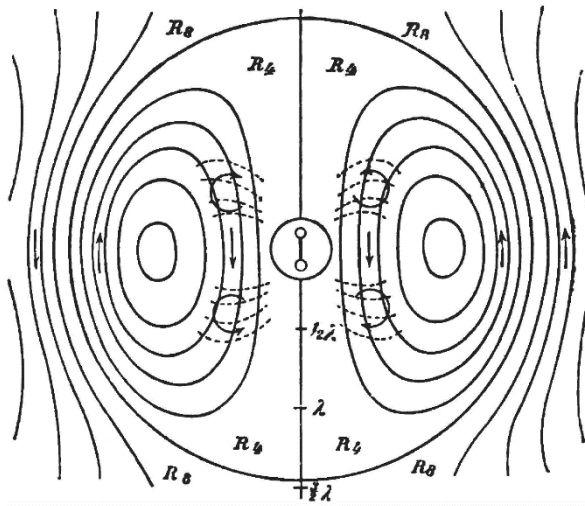

Fig. 27.

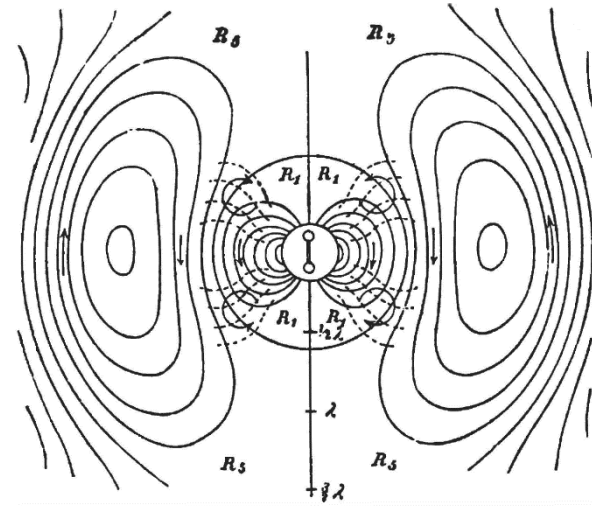

Fig. 28.

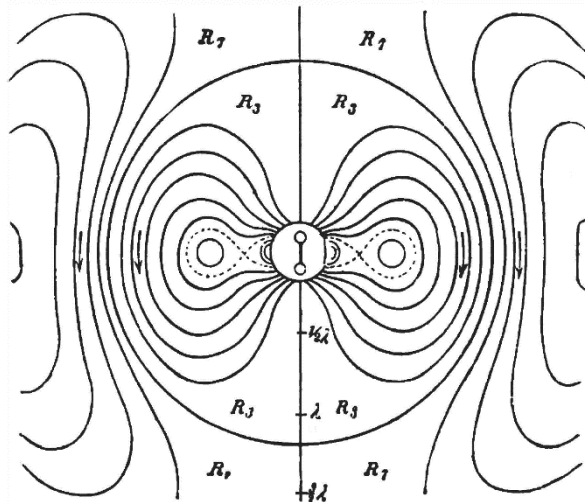

Fig. 30.

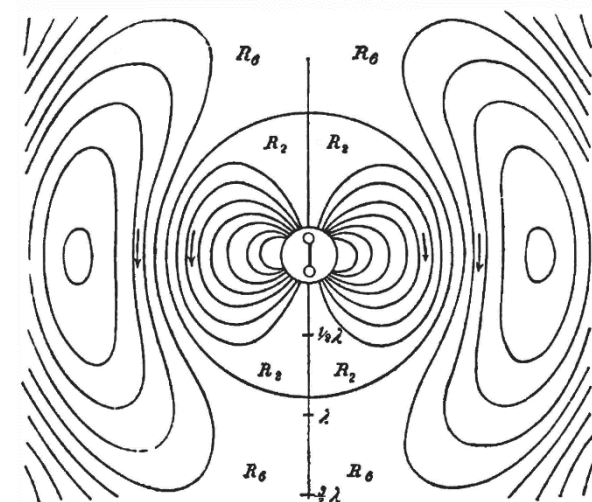
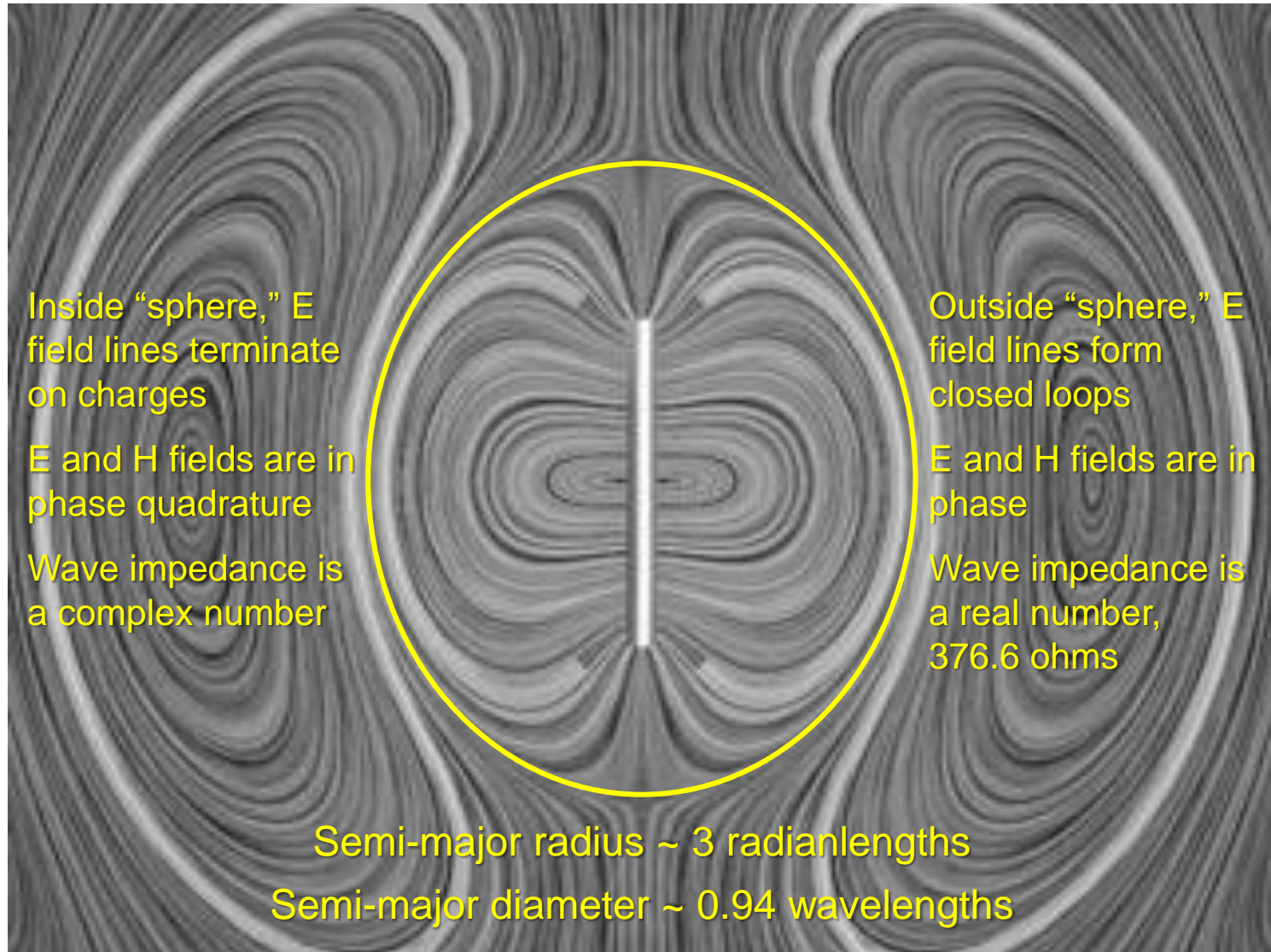

Fig. 29.

# The Radiansphere: Electric Field of a Halfwave Dipole





# Dipole Fields Animations

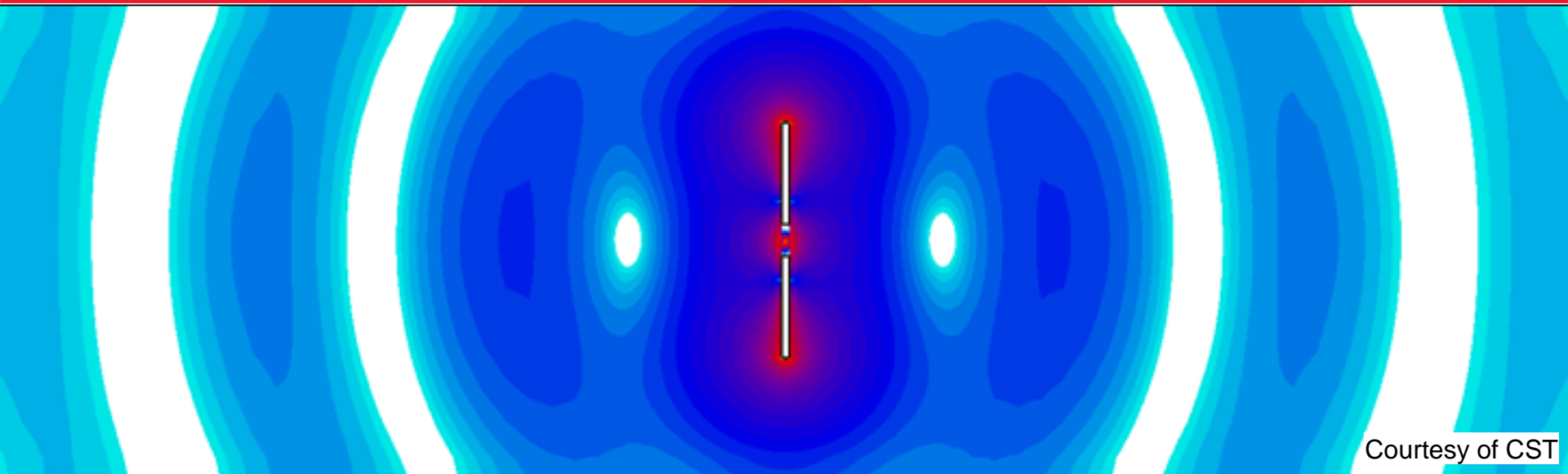

Courtesy of CST

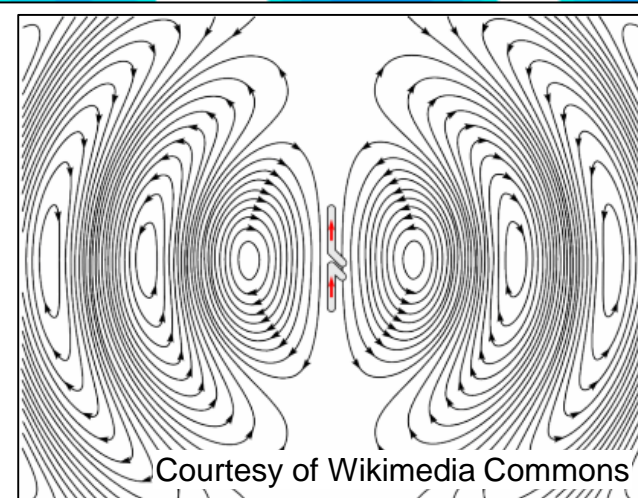

Courtesy of Wikimedia Commons

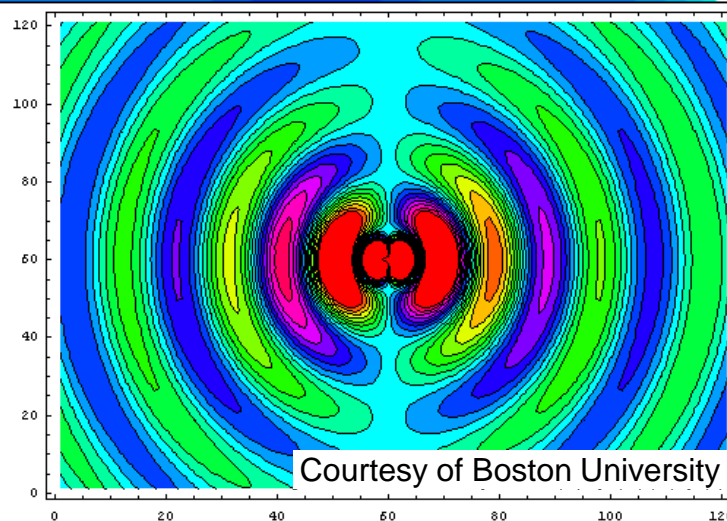

Courtesy of Boston University

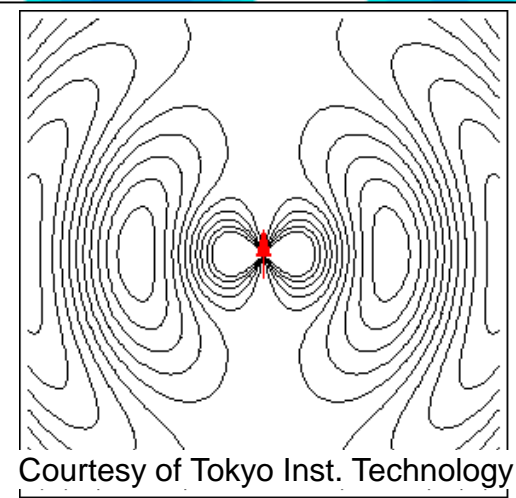

Courtesy of Tokyo Inst. Technology

View PowerPoint in Slide Show mode (Shift F5) to see field animations.

# Poynting Vector of the Infinitesimal Dipole

$$\mathbf{S} = \frac{1}{2} \mathbf{E} \times \mathbf{H}^* = \mathbf{a}_r S_r + \mathbf{a}_\theta S_\theta + \mathbf{a}_\phi 0$$

$$S_r = \frac{1}{2} (E_\theta H_\phi^* - E_\phi H_\theta^*)$$

Real power

$$= \frac{\eta \sin^2 \theta}{2} \left( \frac{k I_0 l}{4\pi r} \right)^2 \left( 1 - \frac{j}{(kr)^3} \right)$$

$$S_\theta = \frac{1}{2} (E_r H_\phi^* - E_\phi H_r^*)$$

Reactive power

$$= -j \frac{\eta \sin 2\theta}{4} \left( \frac{k I_0 l}{4\pi r} \right)^2 \left( \frac{2}{kr} \right) \left( 1 + \frac{1}{(kr)^2} \right)$$

$$S_\phi = \frac{1}{2} (E_r H_\theta^* - E_\theta H_r^*) = 0$$

- Power flow has real and reactive parts
- Real power flows radially from the origin out to infinity
  - Real power density decreases as inverse square
- Reactive power circulates in the near field
  - Reactive power density decreases as inverse cube and inverse fifth power
- In the far field, power flow is real

# Far Field Gain of Infinitesimal Dipole

- Gain and directivity are functions of direction
- Gain is directivity with losses included
- For lossless antennas, gain and directivity are the same
- Example: Infinitesimal dipole

$$G(\theta, \phi) = D(\theta, \phi)$$

$$= \frac{S_r(\theta, \phi)}{\frac{1}{4\pi} \oiint S_r(\theta, \phi) \sin \theta \, d\theta \, d\phi}$$

$$= \frac{\sin^2 \theta}{\frac{1}{4\pi} \oiint \sin^3 \theta \, d\theta \, d\phi}$$

$$= \frac{3}{2} \sin^2 \theta$$

$$G_{max} = 1.5 \quad \text{for } \theta = 90^\circ$$

(1.76 dBi or -0.39 dBd)

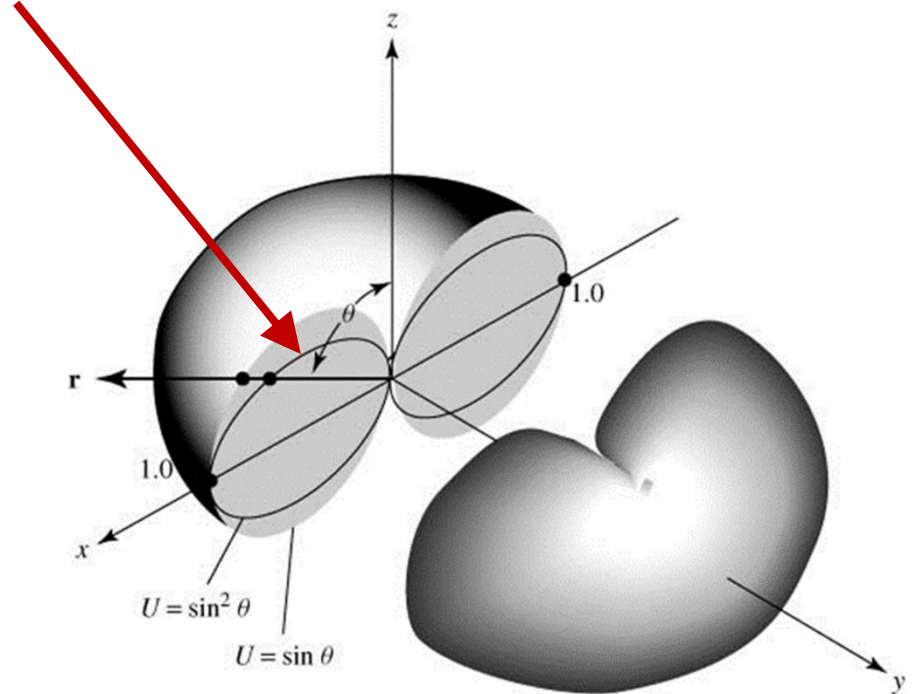



# Halfwave Dipole Pattern Compared to Isotropic

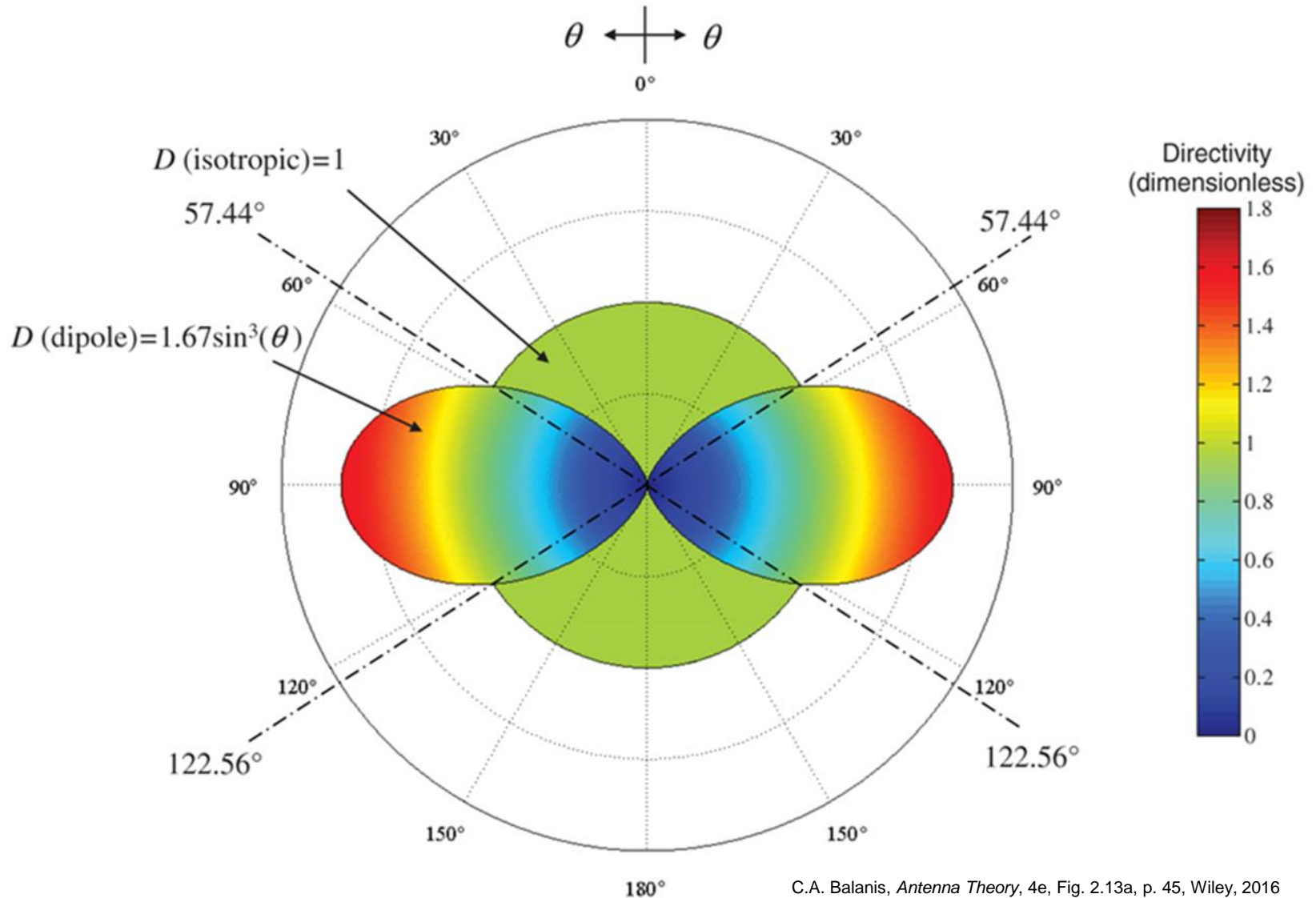

C.A. Balanis, *Antenna Theory*, 4e, Fig. 2.13a, p. 45, Wiley, 2016

# Gain Pattern of $0.25\lambda$ Dipole

---

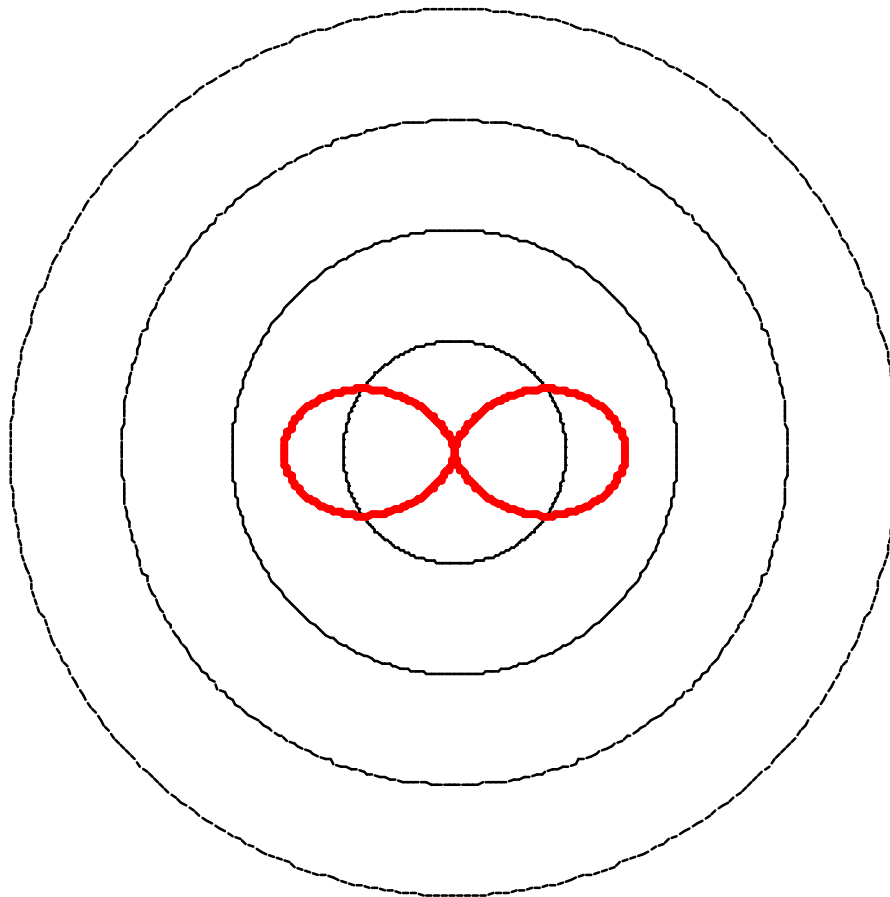

# Gain Pattern of $0.5\lambda$ Dipole

---

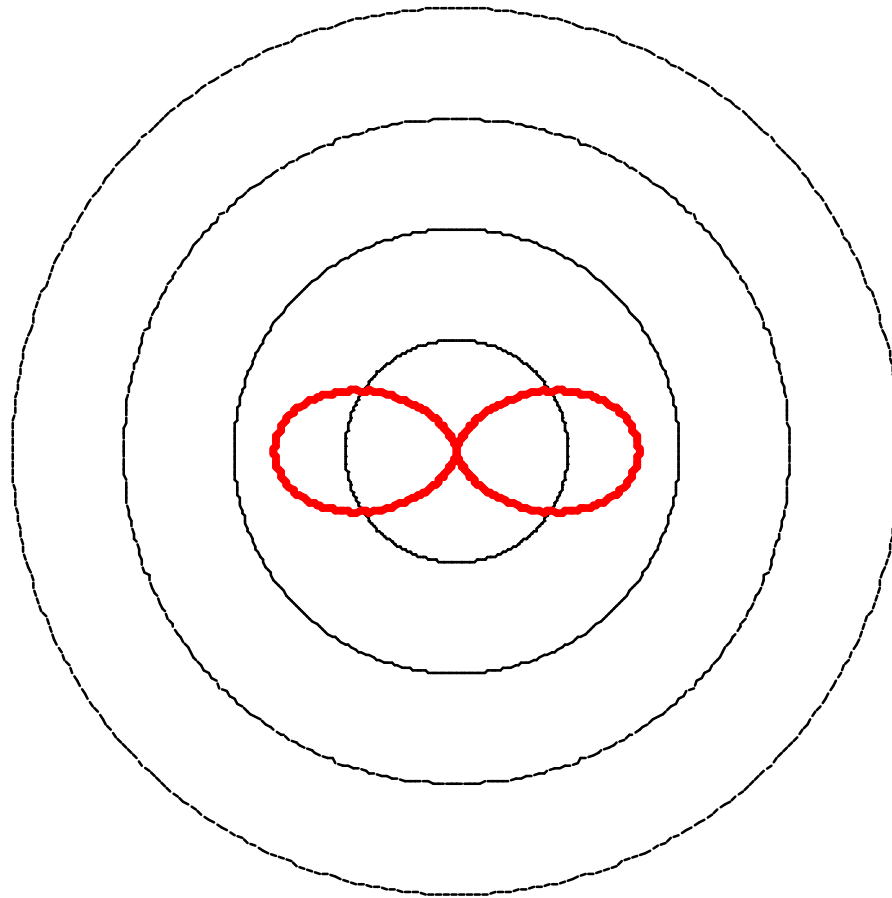

# Gain Pattern of $0.75\lambda$ Dipole

---

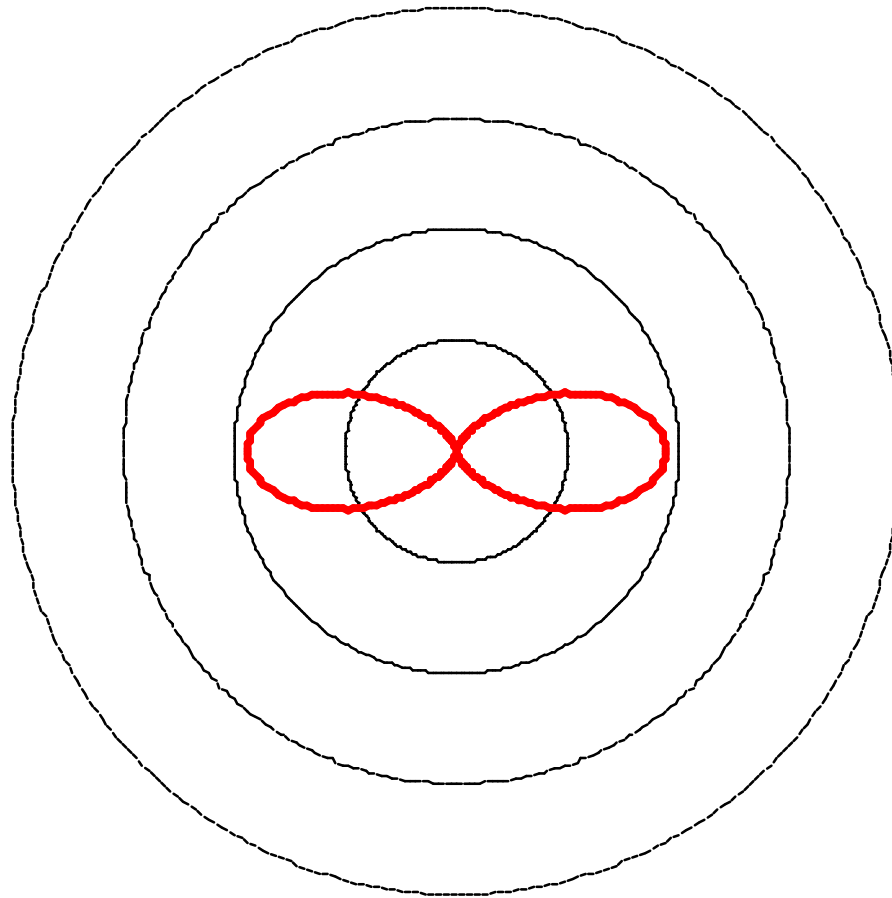

# Gain Pattern of $1\lambda$ Dipole

---

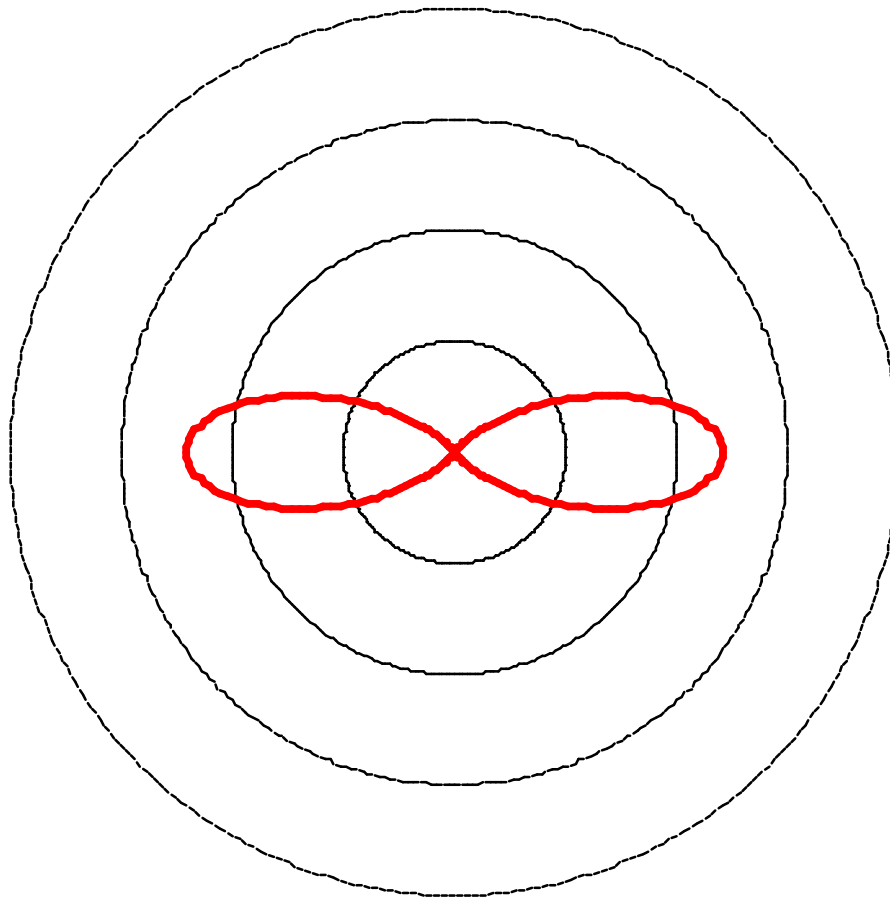

# Gain Pattern of $1.25\lambda$ Dipole

---

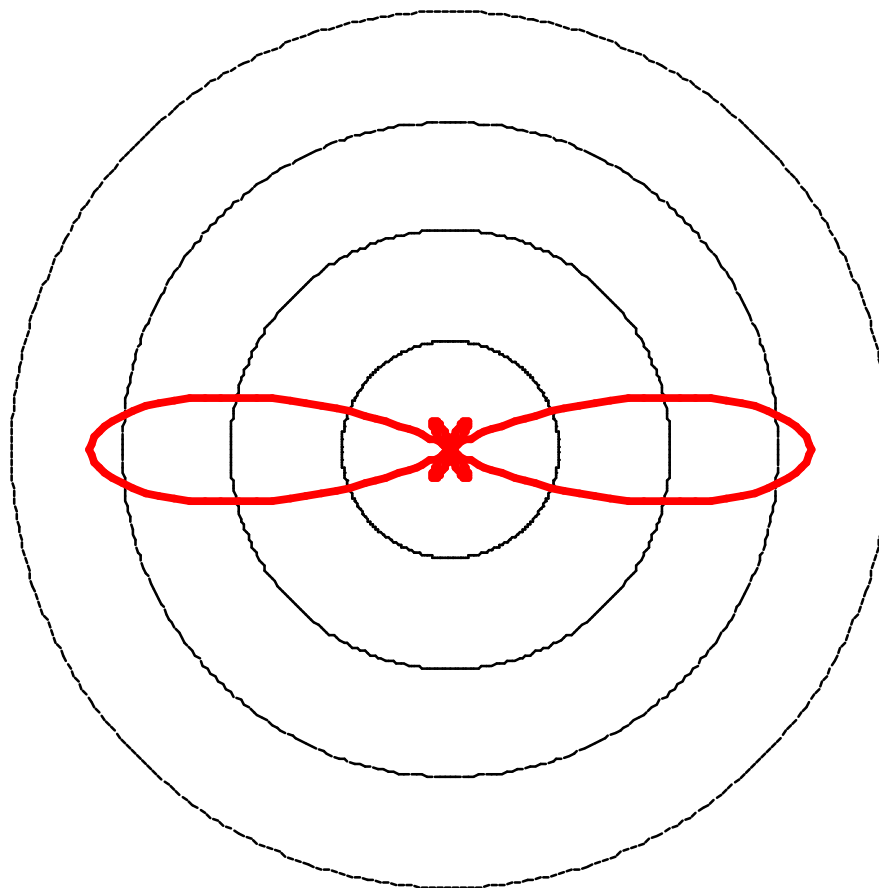

# Gain Pattern of $1.5\lambda$ Dipole

---

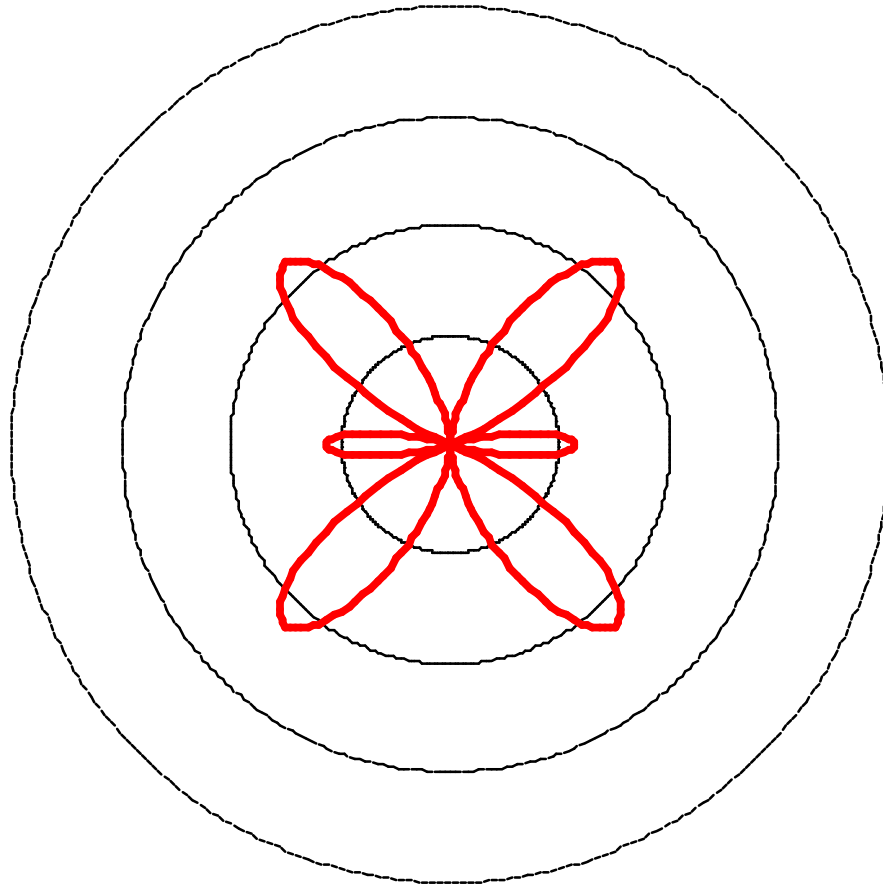

# Gain Pattern of $1.75\lambda$ Dipole

---

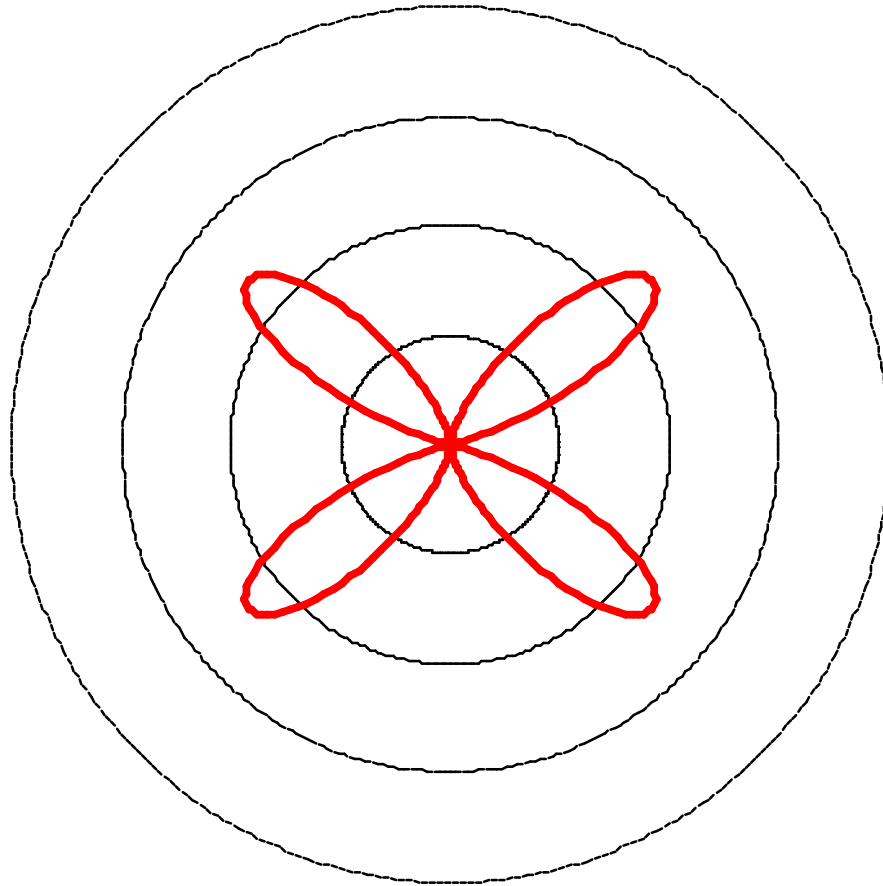



# Gain Pattern of $2\lambda$ Dipole

---

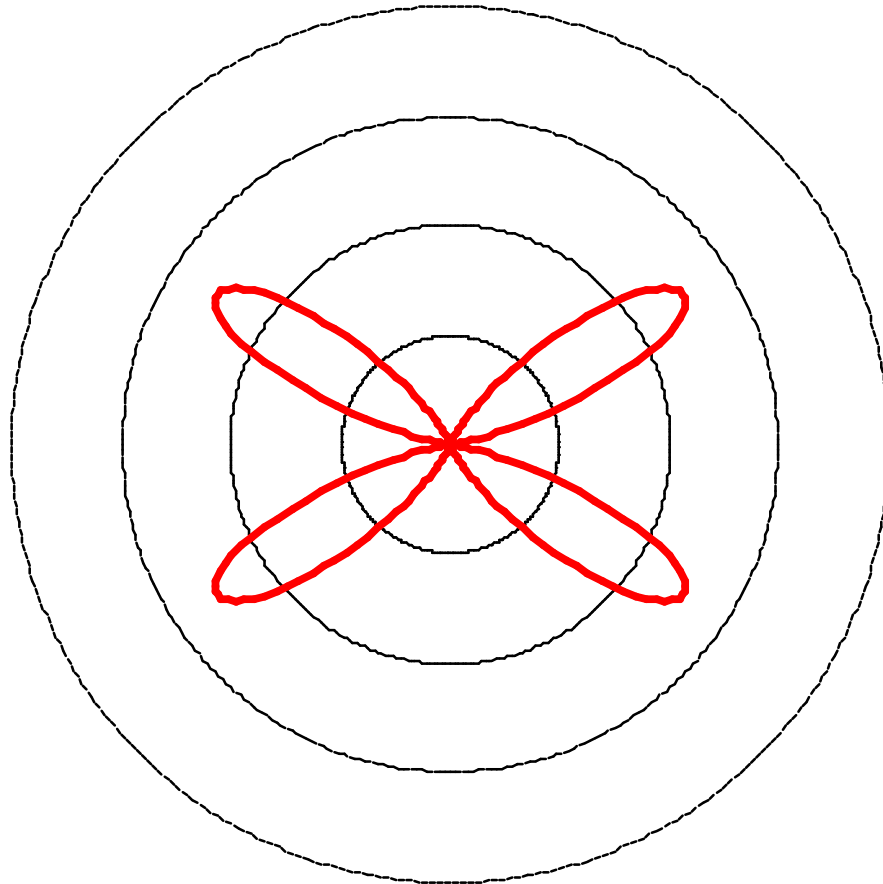

# Gain Pattern of $2.25\lambda$ Dipole

---

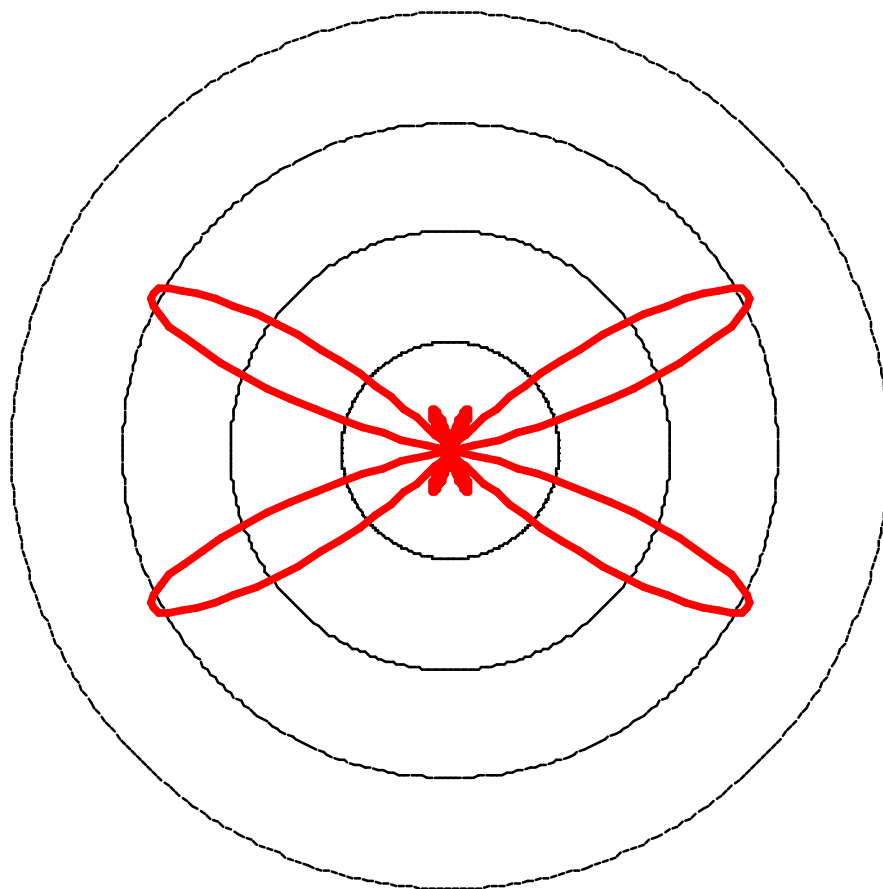

# Gain Pattern of $2.5\lambda$ Dipole

---

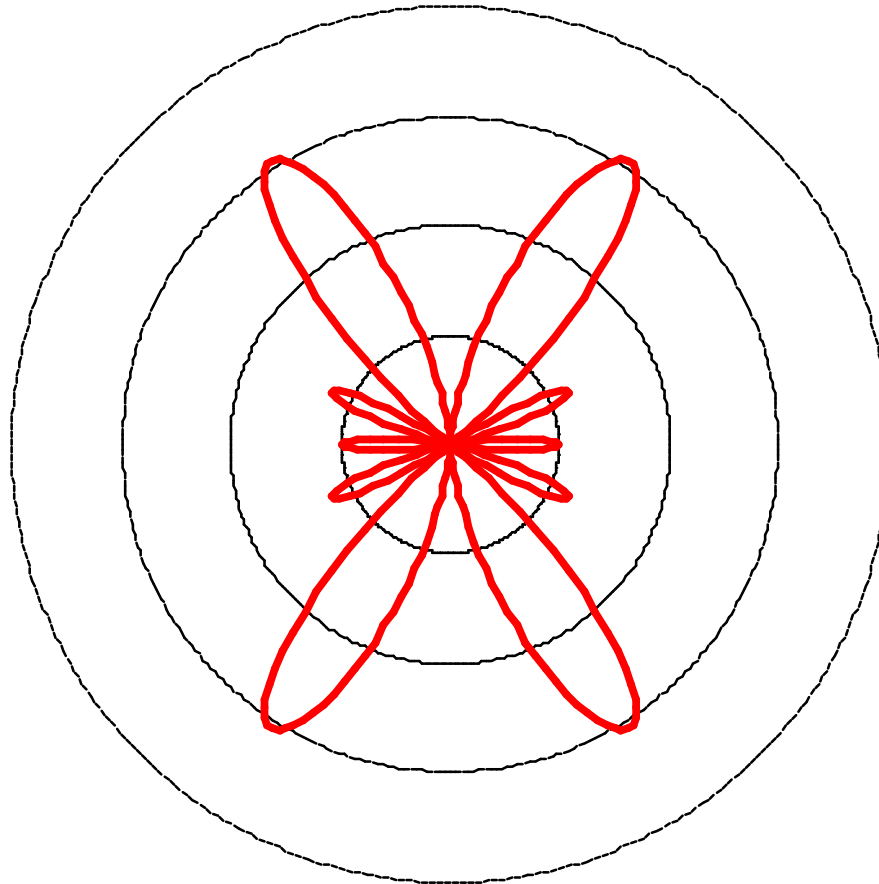

# Gain Pattern of $2.75\lambda$ Dipole

---

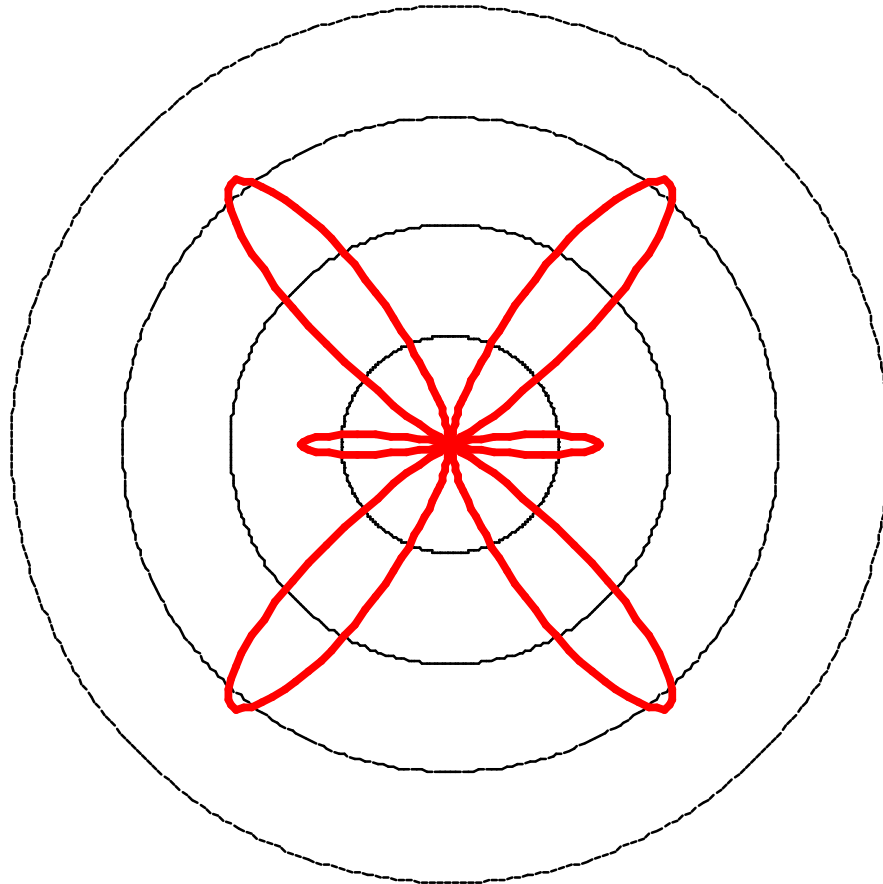

# Gain Pattern of $3\lambda$ Dipole

---

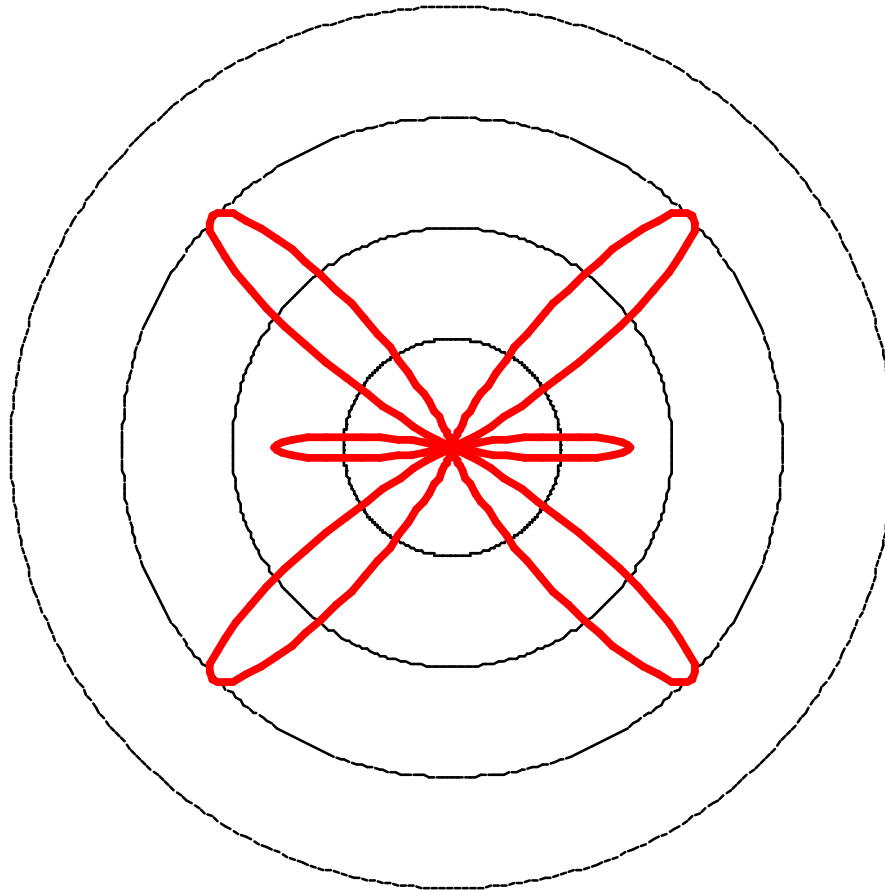

# Dipole Directivity and Gain versus Length

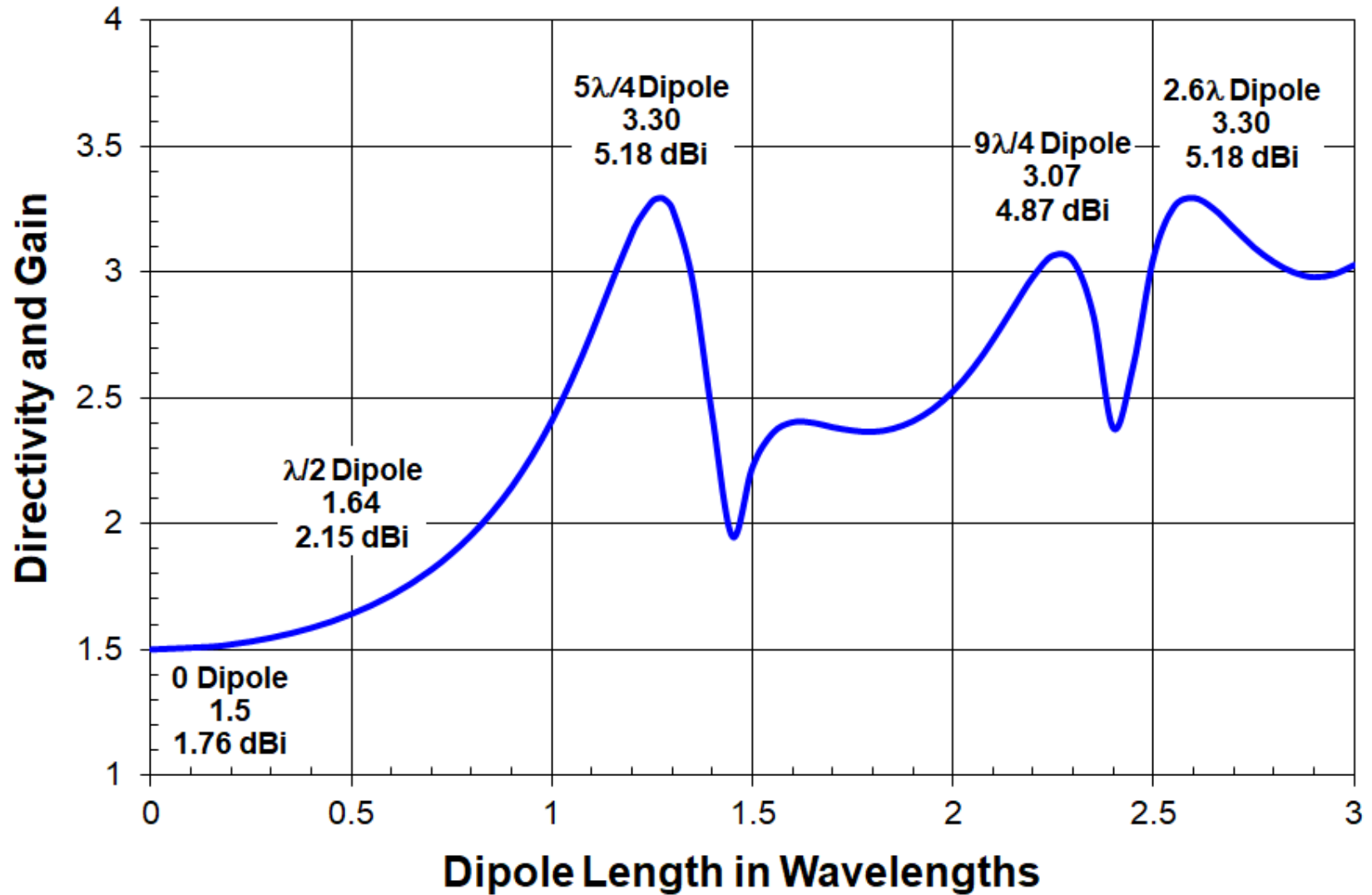

# Another Cat at Work

- A dipole shrinks to nothing and disappears from view, yet positive gain remains



Cheshire Cat Vanishing, by John Tenniel, 1865

---

# Receiving



# Friis Equation – Classical and Quantum Versions

- Receive antenna power

$$P_{Rx} = \frac{P_{Tx} G_{Tx} A_{Rx}}{4\pi d^2} \quad \text{watts}$$

- Receive antenna photon capture rate

$$R_{Rx} = \frac{P_{Tx} G_{Tx} A_{Rx}}{4hf\pi d^2} \quad \text{photons per second}$$

where

$P_{Tx}$  = Transmit power in watts

$G_{Tx}$  = Gain of transmit antenna toward receive antenna

$A_{Rx}$  = Capture area of receive antenna toward transmit antenna

$d$  = Distance between antennas

$h$  = Planck's constant

# Question

---

- **If a dipole's size shrinks to zero, how can it capture any photons at all?**
- **Don't all the photons miss a target if it is infinitesimal?**

# Friis Equation – Alternate Versions

- Fundamental relation

$$A_{Rx} = \frac{\lambda^2}{4\pi} G_{Rx}$$

- Receive antenna power

$$P_{Rx} = P_{Tx} G_{Tx} G_{Rx} \left( \frac{\lambda}{4\pi d} \right)^2 \quad \text{watts}$$

- Receive antenna photon capture rate

$$R_{Rx} = P_{Tx} G_{Tx} G_{Rx} \frac{1}{hf} \left( \frac{c}{4\pi f d} \right)^2 \quad \text{photons per second}$$

- Since receive dipole gain is bounded away from zero, the photon capture rate becomes infinite as frequency decreases!

# How Does a Receiving Antennas Receive?

- **When an antenna receives an incoming wave**

- Incident wave excites currents in the antenna
- The antenna creates “scattered” fields and radiates
- Incident and scattered fields sum
- Poynting vector changes direction

$$\mathbf{S} = \frac{1}{2} (\mathbf{E}_{incident} + \mathbf{E}_{scattered}) \times (\mathbf{H}_{incident}^* + \mathbf{H}_{scattered}^*)$$

- Field energy and momentum follow the Poynting vector

- **Then magic happens**

- The new Poynting vector goes to the antenna
- The antenna absorbs energy from the incident wave field

- **Question: What do photons do?**

- If photons only travel in straight lines, how do energy flux and momentum know to bend or curve through space?
- The same question arises in other contexts such as OAM vortex beams
- Is this nonlocality, entanglement, or what?

Classical physics permits us to calculate reception exactly.  
Modern physics cannot even explain how photons travel.

# Answer – Engineers Calculate, Physicists Pontificate



Professional discussion

# Comments on Dipole Radiation Patterns

## ■ Transmitting

- A dipole's gain depends on its length
- In free space, a non-resonant  $1.25\lambda$  dipole has the maximum possible directivity and gain among all single-lobed dipole radiation patterns
- Directivity is 3.28 compared to 1.64 for a half-wavelength dipole
- Gain is 5.16 dBi
- As a dipole shrinks in size, its directivity does **NOT** go to zero
- An infinitesimal dipole has directivity 1.5
- A nonresonant lossless infinitesimal dipole has gain 1.76 dBi
- This is the smallest gain that a lossless dipole can have

## ■ Receiving

- Effective area of a lossless dipole is

$$A = \frac{\lambda^2}{4\pi} G = \frac{c^2}{4\pi f^2} G$$

- As a lossless dipole shrinks,  $G$  converges to 1.5, and effective area increases without limit
- However bandwidth converges to zero in accordance with the Chu limit

E. Socher, et al., "On the Relationship between the Physical Aperture and the Scattered Power from a Receiving Antenna," *IEEE Int. Symp. Antennas and Propagation*, July 2014.

---

# Special Effects

# Impedance of Horizontal Halfwave Dipole over Ground

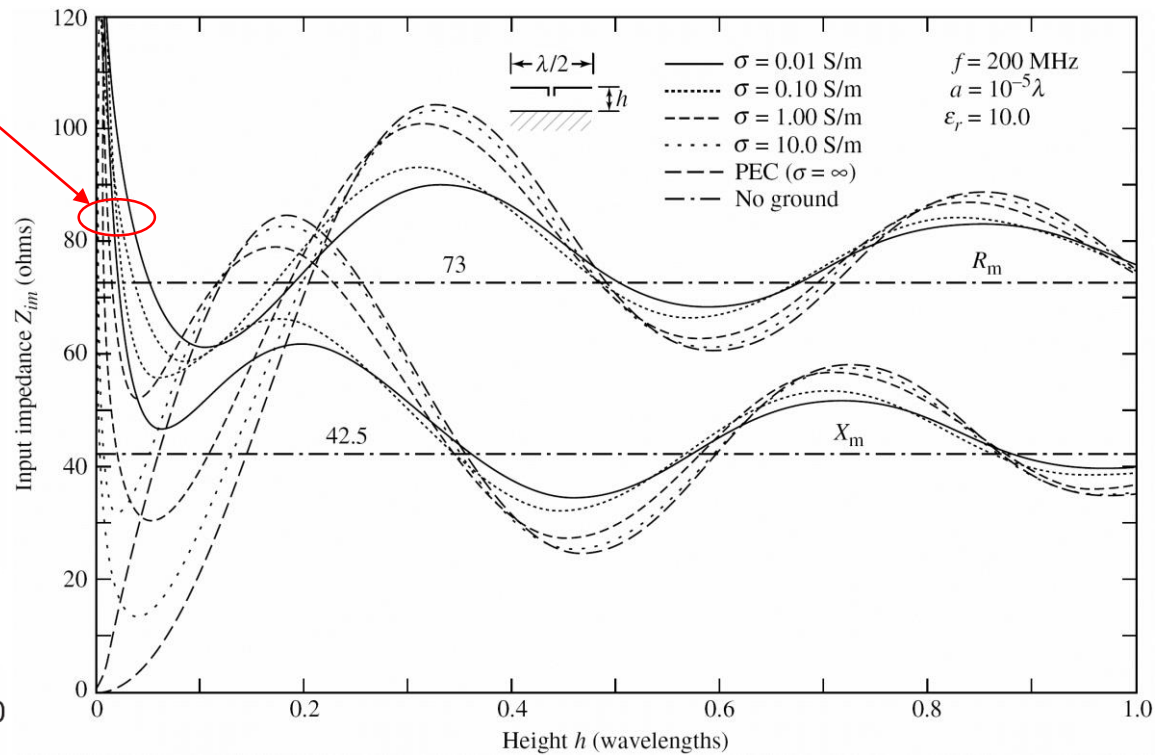
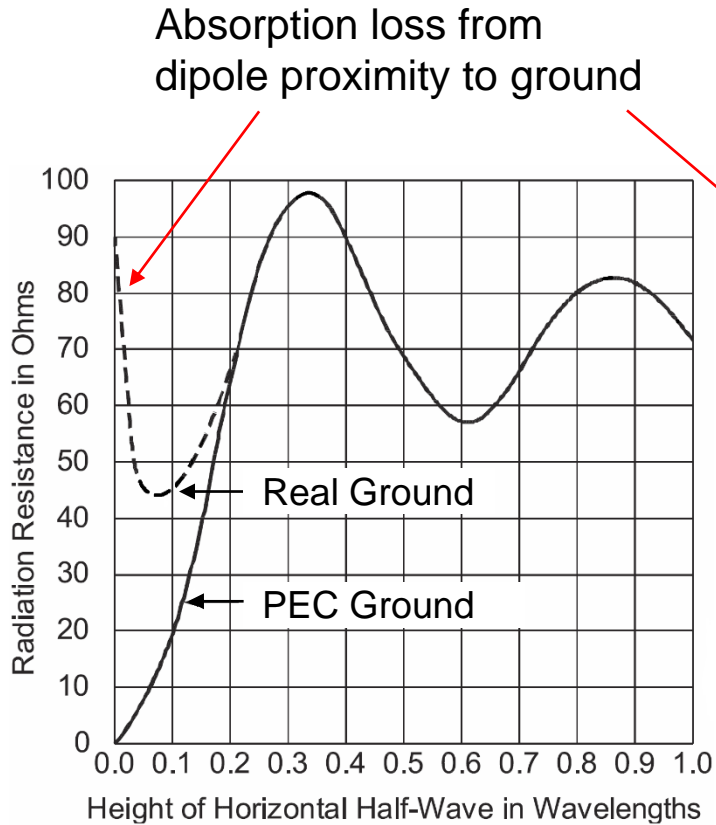

C.A. Balanis, *Antenna Theory*, 4e, Fig. 2.13a, p. 45, Wiley, 2016



# Field Patterns of Vertical Halfwave Dipoles over Ground

Frequency 15 MHz

Field strength at 80 wavelengths on linear scale

$|E_{\theta}|$  in all constant  $\phi$ -planes

Dipole length 10 meters, diameter 10 cm

Center above ground 8 meters

Bottom above ground 3 meters

Equal gap voltage all cases

	$\epsilon_g$	$\sigma$
—	1	0
- - -	5	0.001
- · - · -	10	0.01
- · - · - · - · -	40	1

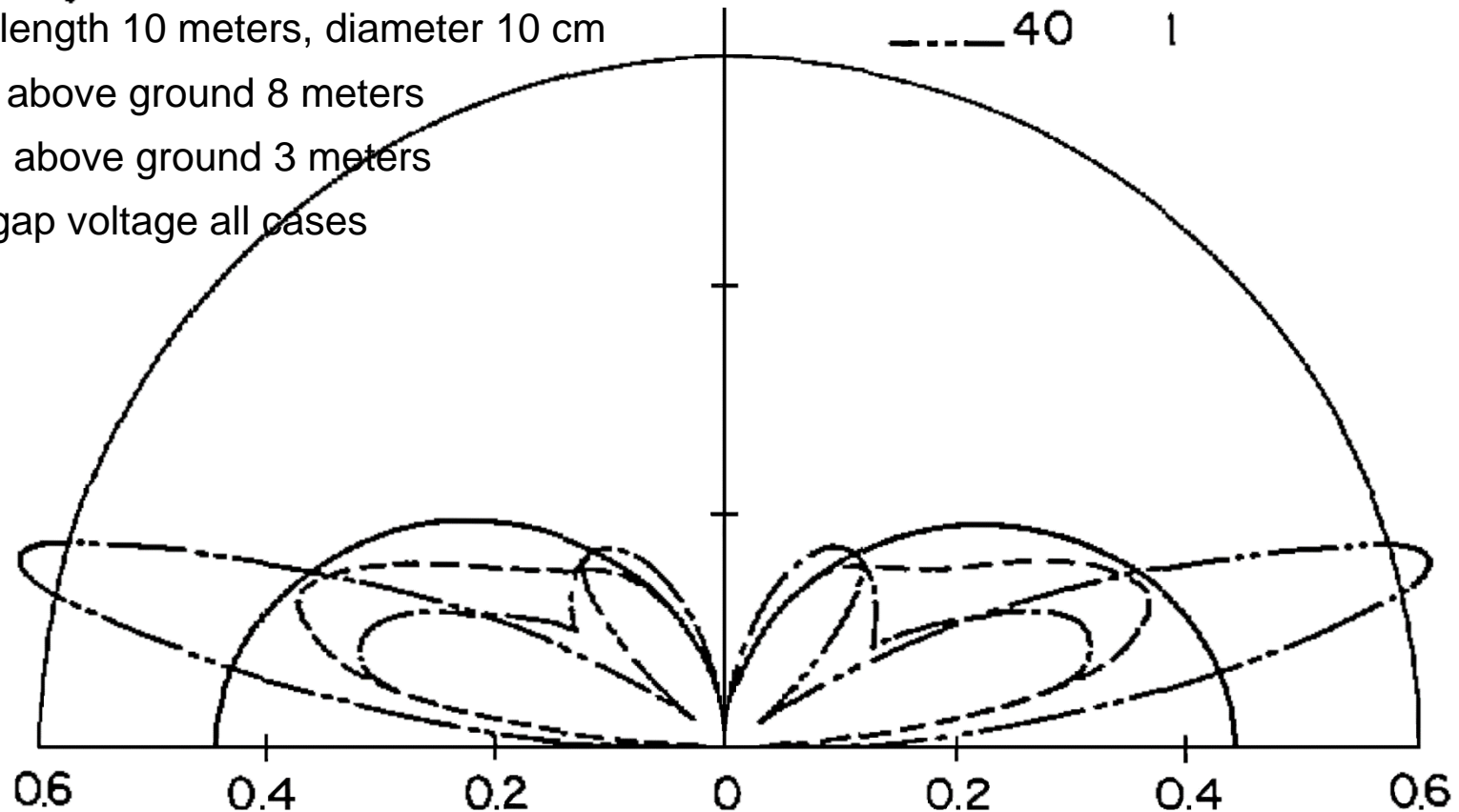

P. Parhami and R. Mittra, "Wire Antennas over a Lossy Half-Space," *IEEE Trans. Antennas and Propagation*, May 1980

# Comments on Special Effects

- **Only isolated dipoles in free space can be analyzed easily**
- **In real cases, an antenna's pattern and/or impedance are affected by objects near the antenna**
  - Parasitic radiators
  - Random metal objects such as feed lines, guy wires, and fences
  - Complex dielectric objects such as insulation on wire or transmission lines, PVC pipe, houses, trees, people and animals
  - Ground and terrain
- **Use CEM (modeling) programs to investigate such effects**
  - Not all modeling programs are equal
  - Modern programs are more capable and accurate than older ones
    - Bigger models
    - More choices of materials and shapes
    - Compute more things (near fields and scattering analysis)
    - Faster computation
    - Better visualization of results (graphs and animations)

# Conclusions

---

- **A simple dipole is a basic antenna whose understanding should be mastered before considering more complicated antennas**
- **Basic properties are impedance and radiation behavior**
- **Radiation is characterized by near-fields, far-fields, and pattern**
- **Receiving antenna analysis and link performance**
  - Directivity, gain, and effective area are used to calculate received power, signal-to-noise ratio, and link performance by the Friis equations
  - “Vector effective length” is used to calculate received voltage, response to polarization or OAM, and “array manifolds” of direction finding arrays
- **Practical effects are best found by antenna modeling programs**
  - How impedance depends on materials or presence of nearby objects
  - How 3D pattern depends on height above ground or terrain shape
  - Use modern software that’s been validated for accuracy against known cases

---

# Resources

# Favorite Antenna Books

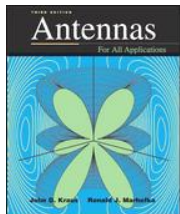
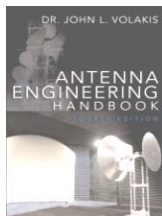
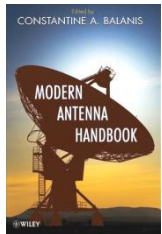
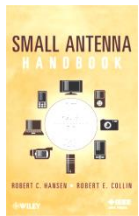
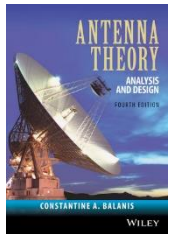

## ■ Books for antenna engineers and students

- C.A. Balanis, *Antenna Theory: Analysis and Design*, 4e, Wiley, 2016
- R.C. Hansen and R.E. Collin, *Small Antenna Handbook*, Wiley, 2011
- C.A. Balanis, ed., *Modern Antenna Handbook*, Wiley, 2008
- J.L. Volakis, ed., *Antenna Engineering Handbook*, 4e, McGraw-Hill, 2007
- J.D. Kraus and R.J. Marhefka, *Antennas*, 3e, McGraw-Hill, 2001

## ■ Free downloadable books – partial list on next slide

## ■ Antenna research papers

- IEEE Xplore subscription online archive, <https://ieeexplore.ieee.org/Xplore/home.jsp>
- IEEE AP-S Digital Archive, 2001-2009 (1 DVD), JD0307
- IEEE AP-S Digital Archive, 2001-2006 (1 DVD), JD0304
- IEEE AP-S Digital Archive, 2001-2003 (1 DVD), JD0301
- IEEE AP-S Digital Archive, 1952-2000 (2 DVDs), JD0351
- Allerton Antenna Applications Symposium DVD archive 1952-2018

## ■ ACES Journal Archives

- <http://www.aces-society.org/journal.php>

# Free Downloadable Books – A Very Small List

- S.J. Orfanidis, *Electromagnetic Waves and Antennas*, Rutgers U., 2016
  - <http://www.ece.rutgers.edu/~orfanidi/ewa>
- D.M. Pozar, *Microwave Engineering*, 4e, Wiley, 2012
  - <http://exam-fever.com/ExamFever/rfmwetb.pdf>
- P-S. Kildal, *Foundations of Antenna Engineering*, 2015
  - <http://kildal.se/index.php/news-page/28-book>
- C.A. Balanis, *Antenna Theory: Analysis and Design*, 3e, Wiley, 2005
  - <https://archive.org/details/Antenna.Theory.Analysis.and.Design3rd.Edition>
- J. Layton, *Directional Broadcast Antennas: A Guide to Adjustment...*, TAB Books, 1974
  - <http://www.americanradiohistory.com/Archive.../Directional-Broadcast-Antennas-Leyton.pdf>
- A.D. Watt, *VLF Radio Engineering*, Pergamon Press, 1967
  - <http://www.introni.it/pdf/Watt%20-%20VLF%20Radio%20Engineering%2014.pdf>
- G.Z. Ayzenberg, *Shortwave Antennas*, revised edition, translated from Russian, 1962
  - <http://www.dtic.mil/docs/citations/AD0706545>
- S. Seely, *Radio Electronics*, McGraw-Hill, 1956
  - <https://archive.org/details/RadioElectronics>
- S.A. Schelkunoff and H.T. Friis, *Antennas: Theory and Practice*, Wiley, 1952
  - <https://archive.org/details/antennastheorypr00sche>
- E.A. Laport, *Radio Antenna Engineering*, McGraw-Hill, 1952
  - <http://snulbug.mtview.ca.us/books/RadioAntennaEngineering>
- K. Henney, *Radio Engineering Handbook*, McGraw-Hill, 1950
  - <https://archive.org/details/radioengineering00henn>
- F. Langford-Smith, *The Radiotron Designers Handbook*, Wireless Press, 1941
  - <https://archive.org/details/radiotrongdesigne00lang>
- K. Henney, *Principles of Radio*, Wiley, 1934
  - <https://archive.org/details/principlesofradi00henn>

# Favorite Antenna Books continued

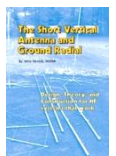
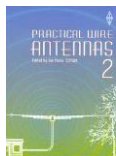
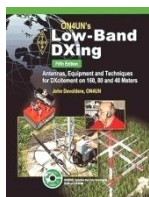
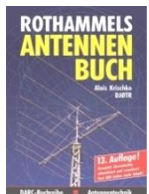
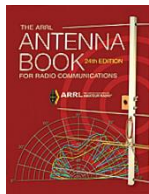

## Books for Radio Amateurs

- H.W. Silver, N0AX, ed., *ARRL Antenna Book*, 24e, ARRL, 2019
- A. Krischke, DJ0TR, ed., *Rothammel's Antenna Book*, English, DARC, 2019
- J. Devoldere, ON4UN, *ON4UN's Low-Band Dxing*, 5e, ARRL, 2011
- I. Poole, G3YWX, ed., *Practical Wire Antennas 2*, RSGB, 2005
- J. Sevick, W2FMI, *The Short Vertical Antenna and Ground Radial*, CQ, 2003
- L. Moxon, G6XN, *HF Antennas for All Locations*, 2e, RSGB, 1983
- J.L. Lawson, W2PV, *Yagi Antenna Design*, ARRL, 1986

## ARRL Antenna Compendium series – eight volumes

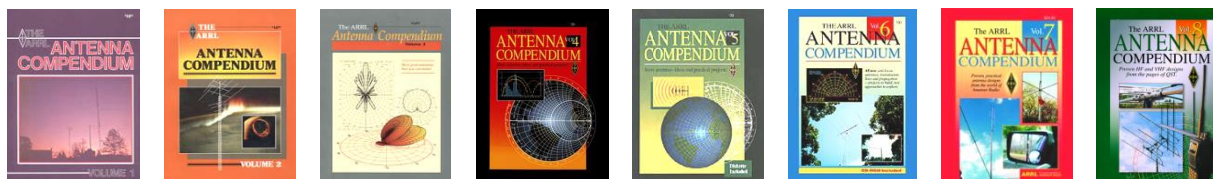

## ARRL Antenna Classics series – eight titles

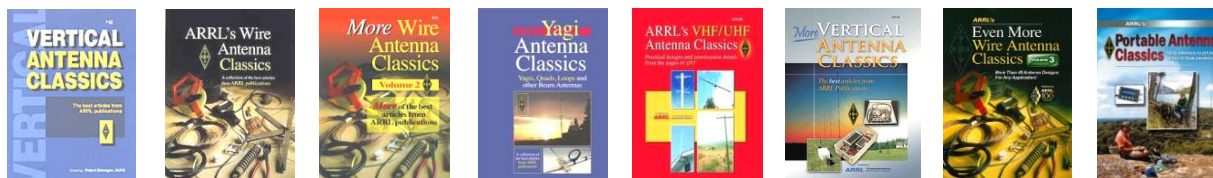



# Recent Antenna Books of Interest

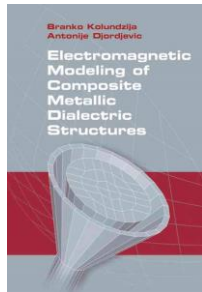

**B.M. Kolundžija and A.R. Djordjević, *Electromagnetic Modeling*, Artech, 2002**



**R.C. Hansen and R.E. Collin, *Small Antenna Handbook*, Wiley, 2011**

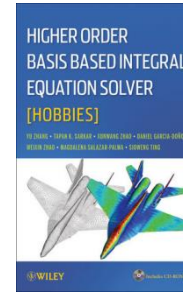

**Y. Zhang et al., *Higher Order Basis Based Integral Theory: Analysis and Design (HOBBIES)*, Wiley, 2012**

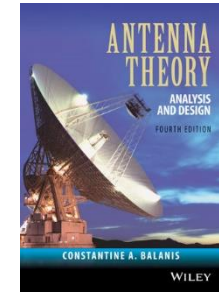

**C.A. Balanis, *Antenna Theory: Analysis and Design*, 4e, Wiley, 2016**

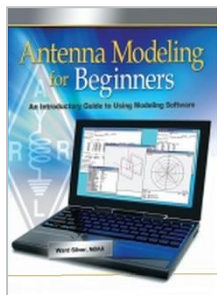

**H.W. Silver, N0AX, *Antenna Modeling for Beginners*, ARRL, 2012**

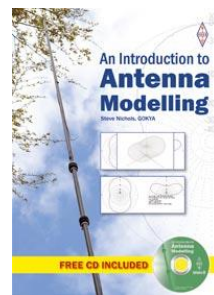

**S. Nichols G0KYA, *An Introduction to Antenna Modelling*, RSGB, 2014**

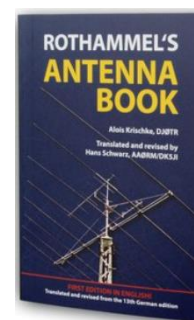

**A. Krischke, DJ0TR, ed., *Rothammel's Antenna Book*, English transl., 13e, DARC, 2019**

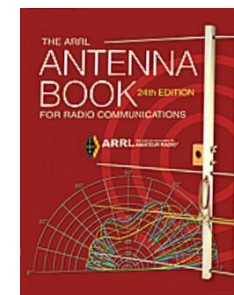

**H.W. Silver, N0AX, ed., *ARRL Antenna Book*, 24e, ARRL, 2019**



# New for 2019

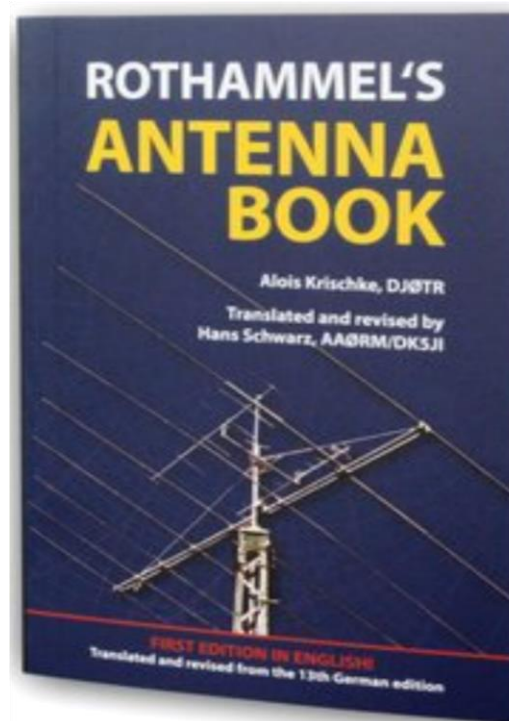
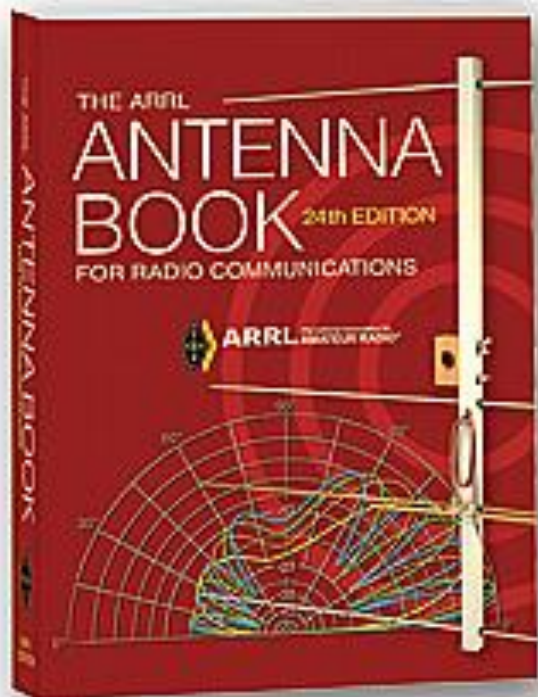

# Four Good History Reads

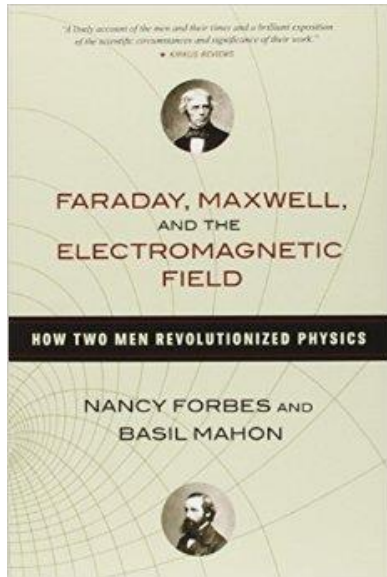

**Nancy Forbes and Basil Mahon, *Faraday, Maxwell, and the Electromagnetic Field*, Prometheus, 2014**

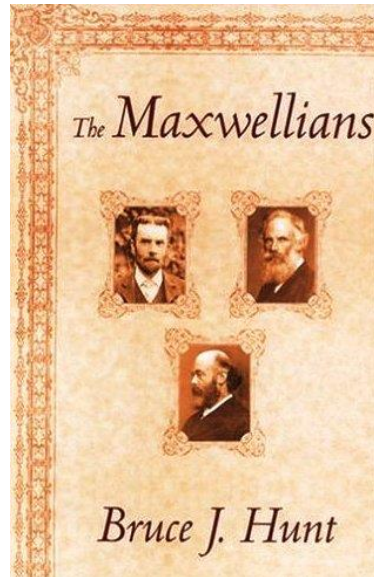

**Bruce J. Hunt, *The Maxwellians*, Cornell University Press, 1991**

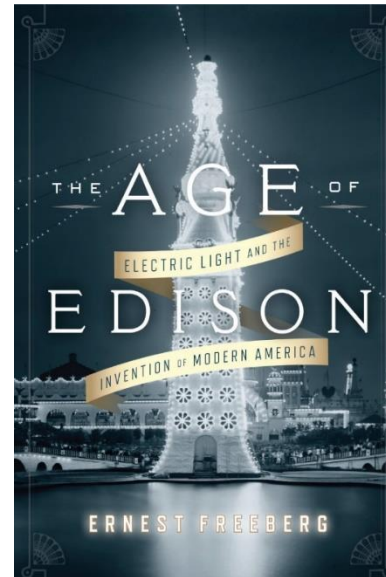

**Ernest Freeberg, *The Age of Edison*, Penguin Books, 2014**

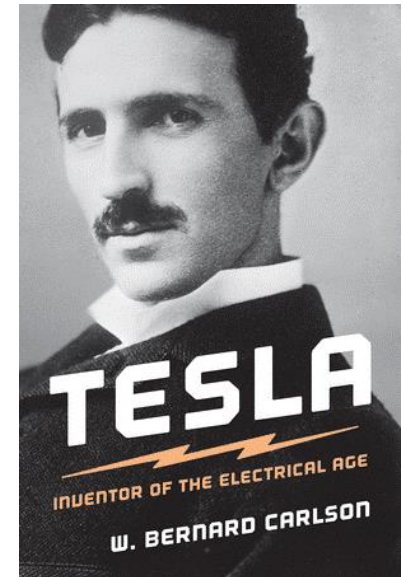

**W. Bernard Carlson, *Tesla: Inventor of the Electrical Age*, Princeton University Press, 2015**



## **The End**

**This presentation will be archived at  
<http://www.fars.k6ya.org/others>**